

SMARTFLOOR PRODUCTS

2020

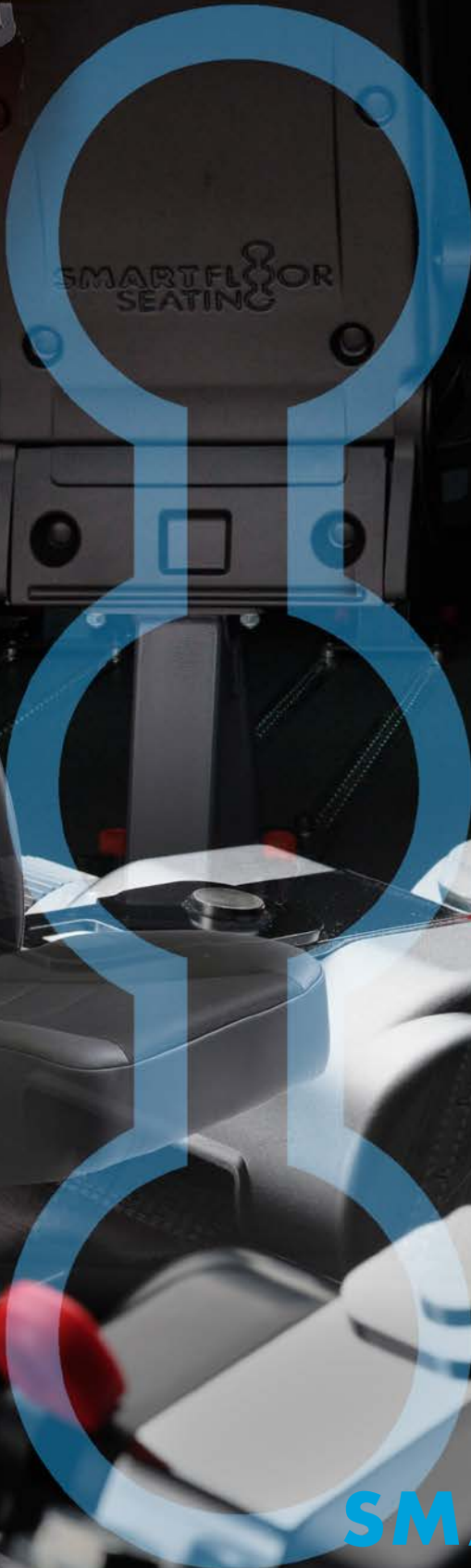

SMARTFLOOR
SEATING

SM

SMARTFLOOR

Flexibility inside



Member of AMF-Brunns group

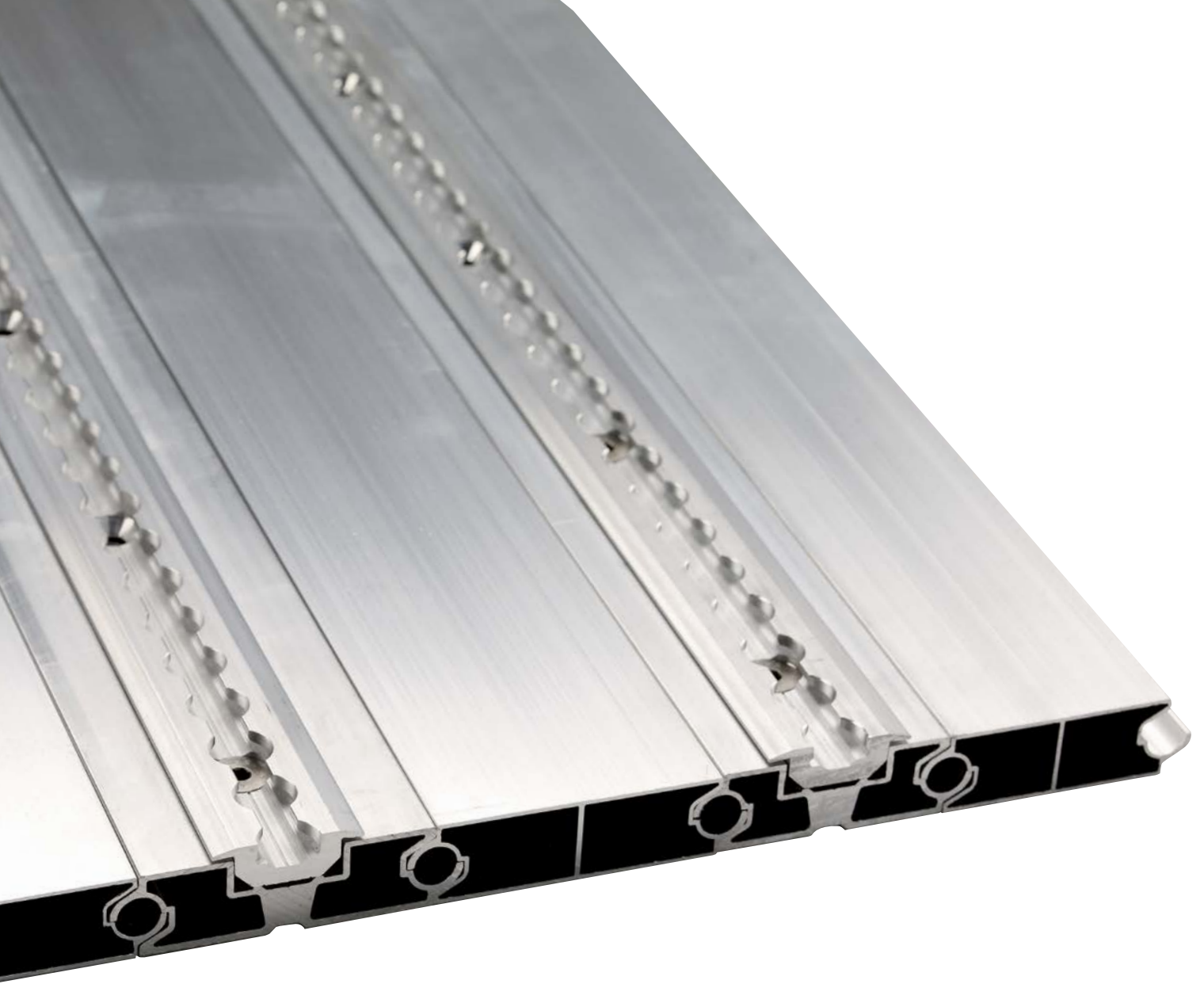

SMART FLOOR

Flexibility inside

CONTENT

1	Vehicle Matrix	6
2	Profiles	8
3	Useful Products	10
4	Floor Plans	12
5	Seat Legs	17
6	Seats	20
7	Wheelchair and Occupant Restraints Protektor	40
8	Head & Back rests / Seatbelt Anchorage	74
	Easypull	76
	Assembly Kits shoulderbelt	78
	FutureSafe	80
	eFutureSafe	81
9	Floor covering	82
10	Stretcher	85
11	Side Steps, Ramps and Lifts	86
12	Cassette Lifts, Channel Ramps, Lowering Suspension	101
13	Conversion Kits	109
14	Test centre	120
	Vehicle tests	
15	Index	124
	Notes & Your Vehicle Plans	126

The products and conversions shown are representatives of those available.
However they may not suit all markets.

Smartfloor holds the right to edit, delete, or modify any information at their own discretion.
We take great care in checking information shown for accuracy, but no warranty is implied
or given by us. Smartfloor is not responsible for typographical errors, mistakes or misprints.

2020 | QS-080-0100-EN/Rev07/01.02.20



Download the free universal app and design your own vehicle lay-out on your iPad. View vehicle lay-out as designed by yourself with top, side and front views. Forward by e-mail your designed lay-outs.



Introduction

Flexibility Inside

The market for wheelchair and standard passenger transportation is always on the move. Multifunctionality is key to delivering good profits in the minibus business. Custom coachbuilders know this better than anybody else. And you know that calls for flexible configurations and quick conversions. Smartfloor sets the pace in this market with RDW, TÜV and VCA approved modular lightweight floors and accessories.

The leading supplier

For over 20 years Smartfloor has been the leading supplier in the Europe for robust, durable lightweight floor components and accessories for minibus taxis. Smartfloor offers safe and flexible solutions for all makes and models. Ingenious attachment technologies allow minibus taxis to be switched over in no time at all from a standard multi-passenger to a wheelchair transportation configuration. And it's just as easy to fit comfortable VIP seats.

Complete

The basis of Smartfloor solutions is formed by an innovative and modular aluminium or magnesium floor with guide rails. Thanks to good contacts with importers and manufacturers Smartfloor enjoys on-going access to the most up-to-date and accurate technical data for almost all minibuses, so our lightweight floors always fit properly and anybody can install them easily on their own. As well as the innovative floor components Smartfloor offers a range of accessories such as seats, wheelchair systems and lifts.

Safety first

Smartfloor considers the safety of wheelchair users of paramount importance. This safety is key in all product and system innovations. Smartfloor has a well-equipped in-house test centre that is suitable for research and approval tests. Smartfloor floors are M1 certified according to UN/ECE R14, R16 and R17 for all major bus makes. Smartfloor wheelchair fastening systems comply with all international standards and the ISO 10542 standard. The key starting point is to make sure the installation is done in line with Smartfloor's instructions. Never forget: 'safety first'!

Easy to install

Our manuals tell you clearly how to install Smartfloor products and accessories safely and quickly. Contact us and we will send them to you at no charge.

The products and conversions shown are representatives of those available. However they may not suit all markets.

Vehicle Matrix

Overview

Vehicle model	Wheel-base	Floor-length	Floor-width	Floor Width Arches	SmartFloor Profile length
Citroën Relay / Jumper L1	3000	2670	1870	1422	3360
Citroën Relay / Jumper L2	3450	3120	1870	1422	3360
Citroën Relay / Jumper L3	4035	3705	1870	1422	3700
Citroën Relay / Jumper XL L4	4035	4070	1870	1422	4500
Citroën Space Tourer L1	2925	2063	1628	1258	3360
Citroën Space Tourer L2	2925	2413	1628	1258	3360
Citroën Space Tourer L3	2925	2763	1628	1258	3360
Fiat Ducato L1	3000	2670	1870	1422	3360
Fiat Ducato L2	3450	3120	1870	1422	3360
Fiat Ducato L3	4035	3705	1870	1422	3700
Fiat Ducato L4	4035	4070	1870	1422	4500
Fiat Talento L1	3100	2540	1660	1268	3360
Fiat Talento L2	3500	2930	1660	1268	3360
Ford Transit Custom L1	2933	2400	1740	1390	3360
Ford Transit Custom L2	3300	2850	1740	1390	3360
Ford Transit (MY 2014) L2	3300	2910	1782	1380	3360
Ford Transit (MY 2014) L3	3750	3356	1782	1380	3360
Ford Transit (MY 2014) L4	3750	4060	1782	1380 / 1154	4500
Hyundai H350 L1	3435	2985	1796	1380	3360
Hyundai H350 L2	3435	3665	1796	1380	3700
Iveco Daily 3520	3520	3130	1800	1032	3360
Iveco Daily 3520L	3520	3540	1800	1032	3700
Iveco Daily 4100	4100	4680	1800	1032	5500
Iveco Daily 4100 L	4100	5125	1800	1032	5500
MAN TGE	3640	3300	1780	1358	3360
MAN TGE	4490	4150	1780	1358	4500
Maxus EV80	3850	3318	1780	1380	3360
Mercedes Benz Vito	3200	2420	1770	1277	3360
Mercedes Benz Vito Long	3200	2670	1770	1277	3360
Mercedes Benz Vito Xtra Long	3430	2850	1770	1277	3360
Mercedes Benz Sprinter FWD (MY2006) L1	3259	2600	1780	1350 / 1228	3360
Mercedes Benz Sprinter RWD (MY2006) L2	3665	3360	1780	1350 / 1228	3360
Mercedes Benz Sprinter RWD (MY2006) L3	4325	4400	1780	1350 / 1228 / 978	4500
Mercedes Benz Sprinter RWD (MY2006) L4	4325	4700	1780	1350 / 1228 / 978	5500

Overview

Vehicle model	Wheel-base	Floor-length	Floor-width	Floor Width Arches	SmartFloor Profile length
Nissan NV 300 L1	3100	2540	1660	1268	3360
Nissan NV 300 L2	3500	2930	1660	1268	3360
Nissan NV 400 L1	3180	2580	1660	1380	3360
Nissan NV 400 L2	3680	3080	1760	1380	3360
Nissan NV 400 L3	4330	3700	1760	1380	3700
Peugeot Boxer SWB L1	3000	2670	1870	1422	3360
Peugeot Boxer L2	3450	3120	1870	1422	3360
Peugeot Boxer L3	4035	3705	1870	1422	3700
Peugeot Boxer L4	4035	4070	1870	1422	4500
Peugeot Traveller L1	2925	2063	1628	1258	3360
Peugeot Traveller L2	2925	2413	1628	1258	3360
Peugeot Traveller L3	2925	2763	1628	1258	3360
Renault Trafic L1	3100	2540	1660	1268	3360
Renault Trafic L2	3500	2930	1660	1268	3360
Renault Master (MY 2015) L1	3180	2580	1760	1380	3360
Renault Master (MY 2015) L2	3680	3080	1760	1380	3360
Renault Master (MY 2015) L3	4330	3700	1760	1380	3700
Renault Master (MY 2015) L4	4332	4370	1760	1080	4500
Toyota Pro Ace L1	2925	2063	1628	1258	3360
Toyota Pro Ace L2	2925	2413	1628	1258	3360
Toyota Pro Ace L3	2925	2763	1628	1258	3360
Vauxhall / Opel Vivaro L1	3100	2540	1660	1268	3360
Vauxhall / Opel Vivaro L2	3500	2930	1660	1268	3360
Vauxhall / Movano L1	3180	2580	1760	1380	3360
Vauxhall / Movano L2	3680	3080	1760	1380	3360
Vauxhall / Movano L3	4330	3700	1760	1380	3700
VW T6 Transporter / Caravelle L1	3000	2543	1692	1244	3360
VW T6 Transporter / Caravelle L2	3400	2943	1692	1244	3360
VW Crafter (MY 2017) L3	3640	3300	1780	1358	3360
VW Crafter (MY 2017) L4	4490	4150	1780	1358	4500

The above dimensions are meant for guidance only, please check with the respective vehicle manufacturers specifications before use. Smartfloor and / or its associated companies cannot be held responsible for any errors e. & o. e.

2

Item code	Item name	Width	3.360 mm	3.700 mm	4.500 mm	5.500 mm
S22001	Profile Smartfloor basic 78	78 mm	•			
S22005	Profile Smartfloor basic 95	95 mm	•			
S22006	Profile Smartfloor basic 234	234 mm	•			
S22009	Profile Smartfloor basic 268	268 mm	•			
S22007	Profile Smartfloor double basic 156 (234)	234 mm	•			
S22008	Profile Smartfloor double basic 173 (251)	251 mm	•			
S22010	Profile Smartfloor spacer 78	78 mm	•			
S22015	Profile Smartfloor spacer 95	95 mm	•			
S22020	Profile Smartfloor spacer 173	173 mm	•			
S22021	Side profile Smartfloor left		•			
S22022	Side profile Smartfloor right		•			
S22025	Profile Smartfloor straight rail		•			
S22030	Profile Smartfloor airline rail		•			
S22035	Profile Smartfloor basic 78	78 mm			•	
S22040	Profile Smartfloor basic 95	95 mm			•	
S22043	Profile Smartfloor basic 234	234 mm			•	
S22044	Profile Smartfloor basic 268	268 mm			•	
S22041	Profile Smartfloor double basic 156 (234)	234 mm			•	
S22042	Profile Smartfloor double basic 173 (251)	251 mm			•	
S22045	Profile Smartfloor spacer 78	78 mm			•	
S22050	Profile Smartfloor spacer 95	95 mm			•	
S22055	Profile Smartfloor spacer 173	173 mm			•	
S22056	Side profile Smartfloor left				•	
S22057	Side profile Smartfloor right				•	
S22060	Profile Smartfloor straight rail				•	
S22065	Profile Smartfloor airline rail				•	
S22201	Profile Smartfloor basic 78	78 mm		•		
S22205	Profile Smartfloor basic 95	95 mm		•		
S22206	Profile Smartfloor basic 234	234 mm		•		
S22209	Profile Smartfloor basic 268	268 mm		•		
S22207	Profile Smartfloor double basic 156 (234)	234 mm		•		
S22208	Profile Smartfloor double basic 173 (251)	251 mm		•		
S22210	Profile Smartfloor spacer 78	78 mm		•		
S22215	Profile Smartfloor spacer 95	95 mm		•		
S22220	Profile Smartfloor spacer 173	173 mm		•		
S22225	Profile Smartfloor straight rail			•		
S22230	Profile Smartfloor airline rail			•		

Item code	Item name	Width	3.360 mm	3.700 mm	4.500 mm	5.500 mm
S22235	Profile Smartfloor basic 78	78 mm				•
S22240	Profile Smartfloor basic 95	95 mm				•
S22243	Profile Smartfloor basic 234	234 mm				•
S22244	Profile Smartfloor basic 268	268 mm				•
S22241	Profile Smartfloor double basic 156 (234)	234 mm				•
S22242	Profile Smartfloor double basic 173 (251)	251 mm				•
S22245	Profile Smartfloor spacer 78	78 mm				•
S22250	Profile Smartfloor spacer 95	95 mm				•
S22255	Profile Smartfloor Spacer 173	173 mm				•
S22260	Profile Smartfloor straight rail					•
S22265	Profile Smartfloor airline rail					•



Profile Smartfloor basic 78



Profile Smartfloor basic 95

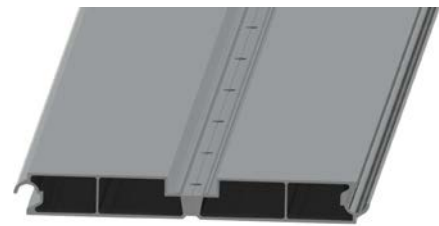

Profile Smartfloor single basic 234

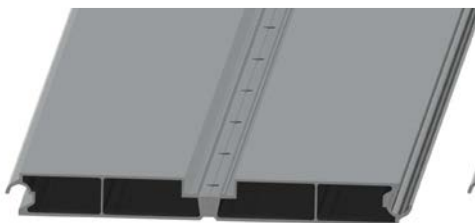

Profile Smartfloor single basic 268

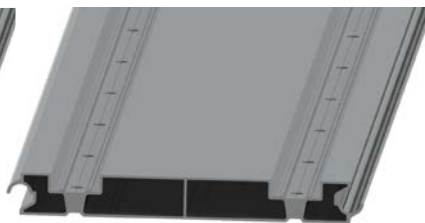

Profile Smartfloor double basic 156 (234)

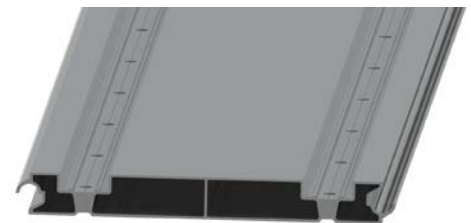

Profile Smartfloor double basic 173 (251)



Profile Smartfloor spacer 78

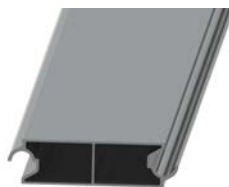

Profile Smartfloor spacer 95



Profile Smartfloor spacer 173



Endprofile left



Endprofile right



Profile Smartfloor airline rail



Profile Smartfloor straight rail

Rail inserts

Item code	Item name	Length
	 	
	<p>Cover strip rubber black</p> <p>Cover strip rubber grey</p>	
H150352	Cover strip rubber grey	
H150351	Cover strip rubber black	



Floor end cover strip stainless steel

Item code	Item name
10007174	Sprinter/Crafter
200470608	Crafter/TGE front (new)
200470557	Crafter/TGE back (new)



Miscellaneous

Item code	Item name	Content	Length
10002002	Bolt M10*25 A2 Stainless steel		25 mm
10003833	Bolt M10*60 A2 Stainless steel		60 mm
10013214	Bolt M10*200 A2 Stainless steel		200 mm
S22075	Assembly plugs		
S22080	Lock plate		

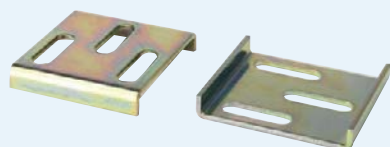



Item code	Item name	Content	Description
10022567	Sikaflex - 552 AT (white)	600 ml	
100022568	Sika Aktivator 205	1000 ml	
20001033	Sika Sense 4615 Adhesive for carpets and vinyls.	24 KG	
20001032	Sikaflex dispenser		
S00011	Gloves polkadot size 10	12 sets	Category 1 
10020774	Smartfloor dome sticker		
S00013	Smartfloor warning window sticker		

Floor Plans

Mercedes Benz Sprinter/ VW Crafter with wheelbase 3665 mm

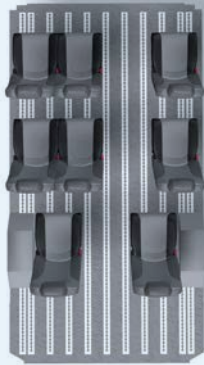
8 seats



8 seats



7 seats and 1 wheelchair



Smartfloor
Designer

DOWNLOAD THE APP • iPad only

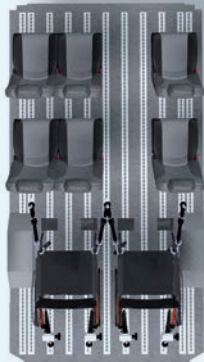

6 seats and 2 wheelchairs



4 seats and 3 wheelchairs

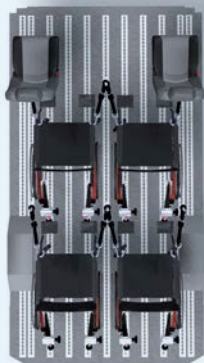

2 seats and 4 wheelchairs

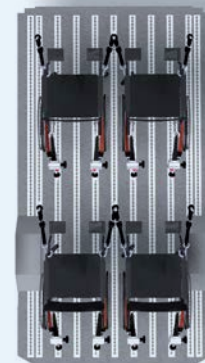

4 wheelchairs

The Smartfloor plans shown are representatives of those available. However they may not suit all markets.

6 seats and 2 folding seats

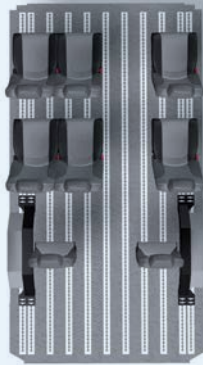

6 seats and 2 folding chairs



6 seats, 1 folding seat and 1 wheelchair



6 seats and 2 wheelchairs



4 seats and 3 wheelchairs



2 seats and 4 wheelchairs



4 wheelchairs

The Smartfloor plans shown are representatives of those available. However they may not suit all markets.

Floor Plans

Mercedes Benz Sprinter/ VW Crafter with wheelbase 3665 mm

4 seats and 4 folding seats



4 seats and 4 folding chairs

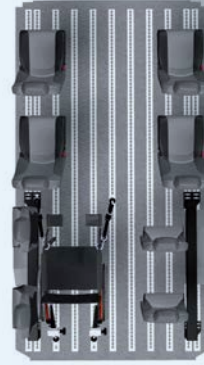

4 seats, 2 folding seats and 1 wheelchair



4 seats and 2 wheelchairs



2 seats and 3 wheelchairs



Smartfloor
Designer

DOWNLOAD THE APP • iPad only



4 wheelchairs

The Smartfloor plans shown are representatives of those available. However they may not suit all markets.

8 folding seats

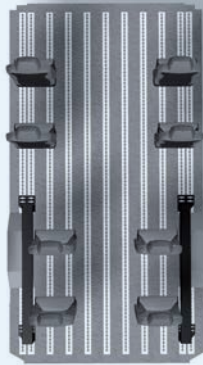

8 folding seats



6 folding seats and 1 wheelchair



7 folding seats and 1 wheelchair



2 folding seats and 3 wheelchairs



4 wheelchairs

The Smartfloor plans shown are representatives of those available. However they may not suit all markets.





Smartfloor seat legs are especially designed for intensive use in passenger transport vehicles. Thanks to various spacers, the lightweight Smartleg seat leg can be suited to fit all rail widths in Smartfloor floors. Smartfloor seat legs are easy to install underneath all types of seats from renowned European manufacturers. All seat legs can be delivered with a wheel at the back as an option to provide the highest possible convenience when having to change position or remove seats in wheelchair transport on a regular basis.

- Various spacers to suit every desired rail distance.
- Highly suitable for all M1 and M2 seat types
- Smartleg can be delivered separately or with mounted spacer
- TNO tested on Smartfloor floors in combination with M2 seats
- Optional wheel at the back for easy manoeuvring in and out of the vehicle
- Robust lightweight construction
- Mounting parts can be delivered as a separate option
- Also available with folding mechanism



Seat Legs
Smartleg and NMI Milleniumleg

Quick locking systems

- 10011973 Smartleg 290 mm
- 10012833 Smartleg 290 mm including Wheelie Wheel
- 10020739 Smartleg 330 mm
- 10020740 Smartleg 330 mm including Wheelie Wheel
- 10020741 Smartleg 360 mm
- 10020742 Smartleg 360 mm including Wheelie Wheel
- 10014449 Smartleg 390 mm
- 92191400 NMI Millenniumleg 280 mm with spigot
- 92191402 NMI Millenniumleg 280 mm with spigot, Wheelie Wheel
- 92191500 NMI Millenniumleg 235 mm with spigot
- 92182100 NMI Millenniumleg 235 mm with spigot, Wheelie Wheel
- 92191600 NMI Millenniumleg 335 mm with spigot
- 10011974 Smartleg spacer 156 mm
- 10013476 Smartleg spacer 164.5 mm
- 10013477 Smartleg spacer 173 mm
- 10013478 Smartleg spacer 181.5 mm
- 10013479 Smartleg spacer 190 mm
- 10013480 Smartleg spacer 234 mm
- 10013481 Smartleg spacer 242.5 mm
- 10013482 Smartleg spacer 251 mm
- 10013483 Smartleg spacer 259.5 mm
- 10013484 Smartleg spacer 268 mm
- 10013485 Smartleg spacer 276.5 mm
- 10013486 Smartleg spacer 285 mm



Fixed mounting

- 10011886 Fixed seat leg, various seats, 290 mm
- 10020737 Fixed seat leg, various seats, 330 mm
- 10020738 Fixed seat leg, various seats, 360 mm
- 10014361 Smartleg 290 mm Fixed
- 10021113 Smartleg 330 mm Fixed



T-bolts

- 10013488 T-Bolt single M8
- 10013489 T-Bolt double 95 mm M8
- 10011522 T-Bolt single M10
- 10011523 T-Bolt double 25 mm M10
- 10011524 T-Bolt double 35 mm M10
- 10011525 T-Bolt double 76 mm M10



Mounting brackets

- 10020102 Mounting bracket Kit 30 x 30 mm Smartleg/Smartfold
- 10020103 Mounting bracket Kit 30 x 30 mm Fixed leg
- 20001208 Mounting bracket 30 x 30 mm



Lockables

- 10011173 AMF Lockable

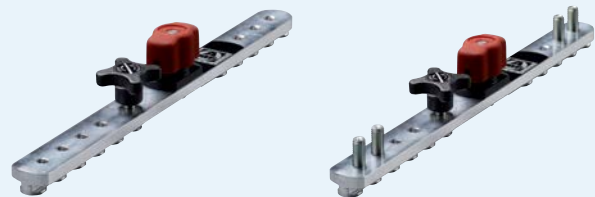

Folding mechanism

- 10013493 Smartfold seat leg 156 mm right hand side control
- 10013494 Smartfold seat leg 173 mm right hand side control
- 10013495 Smartfold seat leg 234 mm right hand side control
- 10015967 Smartfold seat leg 156 mm left hand side control
- 10015968 Smartfold seat leg 173 mm left hand side control
- 10015969 Smartfold seat leg 234 mm left hand side control

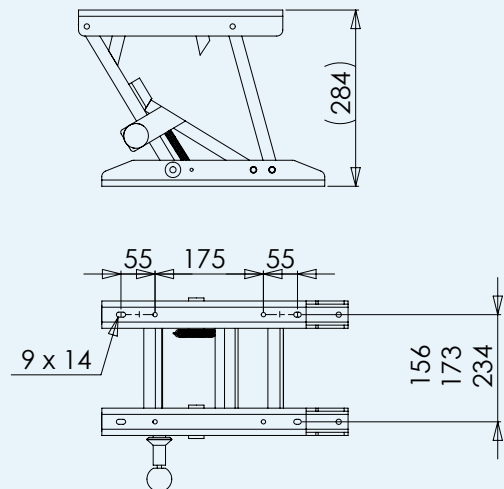

- Smartfold seatleg has been tested for all seats up to a weight of 26 KG
- M1 tested and approved by RDW (Test report RDW-76/115-0715)
- Provides a more easy entrance with chairs placed at the door of the vehicle
- Easy to operate by pulling out a pin
- Color: black

- 200403675 Folding mechanism Ford Transit Custom

- Easy to handle with unlock button and foot pedal
- Seat and seat leg are fixed by screws



5



	Part nr.	10012833 * Smartleg (2 per seat)	92191402 * NMI Milleniumleg (2 per seat)	10011886 * Fixed seat leg (2 per seat)	10014361 * Smartleg Fixed (2 per seat)	20001550 Lowleg	10013493 * Smartfold seat leg	10020754 * Single seatleg Tip&fold	10020931 * Single seatleg Flip-Up	20001508 Smartride	10019153 * Single wheel arch frame	10019157 * Double wheel arch frame	10023045 Business base	10023046 Business turning base
Smartseat easy/reclining	10023317*	x	x	x	x		x							
Smartseat Tip & Fold	10023325*								x		x	x	x	
Smartseat Flip-Up	10023329*						x			x				
Smartseat Easy XL	10023337*	x	x	x	x			x						
Smartseat RV	10023345*	x	x	x	x			x						
Smartseat business seat incl. base	10023045*												x	x
Mountingmaterial needed per Seat														
T-Bolt single M8	10013488			2										
T-Bolt double 95 mm M8	10013489			2										
T-Bolt single M10	10011522				2	2	2	2	2					
T-Bolt double 25mm M10	10011523				2									
T-Bolt double 35mm M10	10011524						2				4	2		
T-Bolt double 76mm M10	10011525					2		2	2			2		
AMF Lockable	10011173				2			2	2					
Spacerplates (depend on rail dist.)		1			1									
Seat mounting kits														
Mounting bracket kit Smartleg	10020102	1	1		1		1	1						
Mounting bracket kit Fixed leg	10020103			1										

* This number is an example, this product is available in multiple sizes.

The Smartseat Easy M1 is designed for maximum passenger comfort and maximum commercial flexibility.

- Fixed or reclining backrest
- Integral 3-point seat belt
- Available in left-hand and right-hand models
- M1 tested and approved by RDW, according to the newest regulation UN/ECE R14, R16, R17, FMVSS/CMVSS 207, 210
- Optional armrest
- Various upholstery options available (including leather)
- Equipped with quick-release Smartleg supports
- Easy to clean

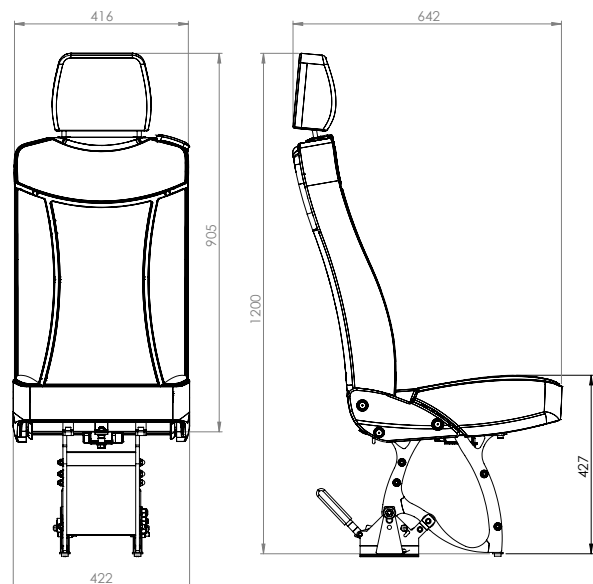

Item Code	Item name		Shoulder belt
10023317	Smartseat Easy MB Maturin		left
10023318	Smartseat Easy MB Maturin		right
10021116	Smartseat Easy Austin		left
10021117	Smartseat Easy Austin		right
10018987	Smartseat Easy Grey artificial leather		left
10018988	Smartseat Easy Grey artificial leather		right
10018989	Smartseat Easy Carmat Code		left
10018990	Smartseat Easy Carmat Code		right
10023319	Smartseat Easy MB Maturin	reclining	left
10023320	Smartseat Easy MB Maturin	reclining	right
10020924	Smartseat Easy Austin	reclining	left
10020925	Smartseat Easy Austin	reclining	right
10018996	Smartseat Easy Grey artificial leather	reclining	left
10018997	Smartseat Easy Grey artificial leather	reclining	right
10018998	Smartseat Easy Carmat Code	reclining	left
10018999	Smartseat Easy Carmat Code	reclining	right

Options			
10019046	Armrest for Smartseat, non-fitted		left
10019047	Armrest for Smartseat, non-fitted		right
10019048	Grab handle rear for Smartseat, non-fitted		
10019049	Grab handle side (black), preassembled		
10019050	Grab handle side (yellow), preassembled		

6



Item Code	Item name		Shoulder belt
10023321	Smartseat Easy MB Maturin	ISOfix	left
10023322	Smartseat Easy MB Maturin	ISOfix	right
10023323	Smartseat Easy MB Maturin	ISOfix	left
10023324	Smartseat Easy MB Maturin	ISOfix	right
10020926	Smartseat Easy Austin	ISOfix	left
10020927	Smartseat Easy Austin	ISOfix	right
10019006	Smartseat Easy Grey artificial leather	ISOfix	left
10019007	Smartseat Easy Grey artificial leather	ISOfix	right
10019008	Smartseat Easy Carmat Code	ISOfix	left
10019009	Smartseat Easy Carmat Code	ISOfix	right
10020928	Smartseat Easy Austin	reclining ISOfix	left
10020929	Smartseat Easy Austin	reclining ISOfix	right
10019016	Smartseat Easy Grey artificial leather	reclining ISOfix	left
10019017	Smartseat Easy Grey artificial leather	reclining ISOfix	right
10019018	Smartseat Easy Carmat Code	reclining ISOfix	left
10019019	Smartseat Easy Carmat Code	reclining ISOfix	right

Options			
10019046	Armrest for Smartseat, non-fitted		left
10019047	Armrest for Smartseat, non-fitted		right
10019048	Grab handle rear for Smartseat, non-fitted		
10019049	Grab handle side (black), preassembled		
10019050	Grab handle side (yellow), preassembled		

Smartseats
Smartseat Tip & Fold M1

New foldable Smartseat Tip & Fold M1 seat with maximum comfort and minimum use of space when folded.

- Extremely small thickness when seat is folded
- Maximum resting possibility
- Very small height from the cushion edge including the entire rotator
- Seat cushion remains blocked after passenger leaves.
- M1 tested and approved by RDW, according to the newest regulation UN/ECE R14, R16, R17, FMVSS/CMVSS 207, 210
- Fully integrated controls and safety belts to avoid injury
- Easy to clean
- Standard with armrest



Item Code	Item name		Shoulder belt
10023325	Smartseat Tip & Fold MB Maturin		left
10023326	Smartseat Tip & Fold MB Maturin		right
10022755	Smartseat Tip & Fold Austin		left
10022756	Smartseat Tip & Fold Austin		right
10019032	Smartseat Tip & Fold Grey artificial leather		left
10019033	Smartseat Tip & Fold Grey artificial leather		right
10019034	Smartseat Tip & Fold Carmat Code		left
10019035	Smartseat Tip & Fold Carmat Code		right
10023327	Smartseat Tip & Fold MB Maturin	ISOfix	left
10023328	Smartseat Tip & Fold MB Maturin	ISOfix	right
10022757	Smartseat Tip & Fold Austin	ISOfix	left
10022758	Smartseat Tip & Fold Austin	ISOfix	right
10019042	Smartseat Tip & Fold Grey artificial leather	ISOfix	left
10019043	Smartseat Tip & Fold Grey artificial leather	ISOfix	right
10019044	Smartseat Tip & Fold Carmat Code	ISOfix	left
10019045	Smartseat Tip & Fold Carmat Code	ISOfix	right

Item Code	Item name
10020754	Single seatleg 270 mm Tip & Fold M1
10020967	Single seatleg 320 mm Tip & Fold M1
10019152	Single seatleg 350 mm Tip & Fold M1
10019153 Sprinter	Single wheel arch frame 280 mm L/R
10019154 Transit / MAN / Crafter	Single wheel arch frame 329 mm L/R
10019155 Master / Movano	Single wheel arch frame 370 mm 105 L/R
10019156 Boxer / Jumper / Ducato	Single wheel arch frame 370 mm 125 L/R
10019157 Sprinter	Double wheel arch frame 280 mm left
10019158 Sprinter	Double wheel arch frame 280 mm right
10019159 Crafter / Transit / MAN	Double wheel arch frame 329 mm left
10019160 Crafter / Transit / MAN	Double wheel arch frame 329 mm right
10020760	Armrest left, preassembled
10020761	Armrest right, preassembled

Item Code	Item name
20001508	Smarride 311 mm

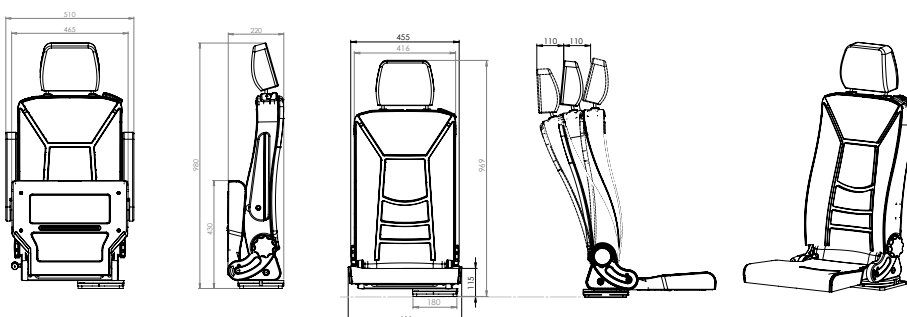

New folding Smartseat Flip-Up M1 seat with maximum comfort and minimum use of space when folded.

- Slim design thickness when seat is folded
- Seat cushion remains locked after passenger leaves.
- M1 tested and approved by RDW, according to the newest regulation UN/ECE R14, R16, R17, FMVSS/CMVSS 207, 210
- Easy to clean



Item Code	Item name		Shoulder belt
10023329	Smartseat Flip-up MB Maturin		left
10023330	Smartseat Flip-up MB Maturin		right
0022759	Smartseat Flip-Up Austin		left
10022760	Smartseat Flip-Up Austin		right
10020789	Smartseat Flip-Up Grey artificial leather		left
10020790	Smartseat Flip-Up Grey artificial leather		right
10020791	Smartseat Flip-Up Carmate Code		left
10020792	Smartseat Flip-Up Carmate Code		right
10023331	Smartseat Flip-up MB Maturin	reclining	left
10023332	Smartseat Flip-up MB Maturin	reclining	right
110022761	Smartseat Flip-Up Austin	reclining	left
10022762	Smartseat Flip-Up Austin	reclining	right
10020799	Smartseat Flip-Up Grey artificial leather	reclining	left
10020800	Smartseat Flip-Up Grey artificial leather	reclining	right
10020801	Smartseat Flip-Up Carmate Code	reclining	left
10020802	Smartseat Flip-Up Carmate Code	reclining	right
10023333	Smartseat Flip-up MB Maturin	ISOfix	left
10023334	Smartseat Flip-up MB Maturin	ISOfix	right
10022763	Smartseat Flip-Up Austin	ISOfix	left
10022764	Smartseat Flip-Up Austin	ISOfix	right
10020844	Smartseat Flip-Up Grey artificial leather	ISOfix	left
10020845	Smartseat Flip-Up Grey artificial leather	ISOfix	right
10020846	Smartseat Flip-Up Carmate Code	ISOfix	left
10020847	Smartseat Flip-Up Carmate Code	ISOfix	right
10023335	Smartseat Flip-up MB Maturin	ISOfix reclining	left
10023336	Smartseat Flip-up MB Maturin	ISOfix reclining	left
10022765	Smartseat Flip-Up Austin	ISOfix reclining	left
10022766	Smartseat Flip-Up Austin	ISOfix reclining	right
10020852	Smartseat Flip-Up Grey artificial leather	ISOfix reclining	left
10020853	Smartseat Flip-Up Grey artificial leather	ISOfix reclining	right
10020854	Smartseat Flip-Up Carmate Code	ISOfix reclining	left
10020855	Smartseat Flip-Up Carmate Code	ISOfix reclining	right

Item Code	Item name
10020931	Seat leg 270 mm for Smartseat Flip-Up
10020968	Seat leg 320 mm for Smartseat Flip-Up
10020932	Seat leg 350 mm for Smartseat Flip-Up



The Smartseat Easy M1 is XL designed for maximum passenger comfort and maximum commercial flexibility.

- Fixed or reclining backrest
- Integral 3-point seat belt
- Available in left-hand belt and right-hand belt models
- M1 tested and approved by RDW, according to the newest regulation UN/ECE R14, R16, R17, FMVSS/CMVSS 207, 210
- Optional armrest
- Various upholstery options available (including leather)
- Equipped with quick-release Smartleg supports
- Easy to clean
- ABS back panel

Optional

- Extra Foam seatcushion
- Seatcushion heating
- Piping
- Upholstered armrest

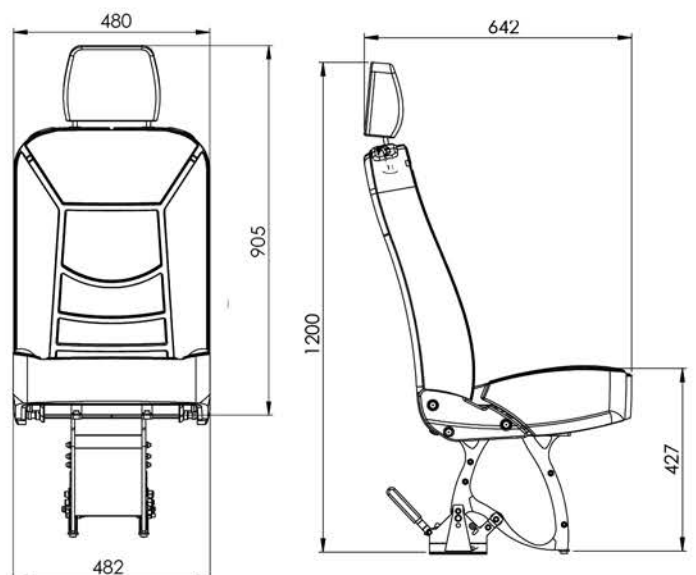

Item Code	Item name		Shoulder belt
10023337	Smartseat Easy XL MB Maturin		left
10023338	Smartseat Easy XL MB Maturin		right
10022767	Smartseat Easy XL Austin		left
10022768	Smartseat Easy XL Austin		right
10020860	Smartseat Easy XL Grey artificial leather		left
10020861	Smartseat Easy XL Grey artificial leather		right
10020862	Smartseat Easy XL Carmat Code		left
10020863	Smartseat Easy XL Carmat Code		right
10023339	Smartseat Easy XL MB Maturin	reclining	left
10023340	Smartseat Easy XL MB Maturin	reclining	right
10022769	Smartseat Easy XL Austin	reclining	left
10022770	Smartseat Easy XL Austin	reclining	right
10020868	Smartseat Easy XL Grey artificial leather	reclining	left
10020869	Smartseat Easy XL Grey artificial leather	reclining	right
10020870	Smartseat Easy XL Carmat Code	reclining	left
10020871	Smartseat Easy XL Carmat Code	reclining	right
10023341	Smartseat Easy XL MB Maturin	ISOfix	left
10023342	Smartseat Easy XL MB Maturin	ISOfix	right
10022771	Smartseat Easy XL Austin	ISOfix	left
10022772	Smartseat Easy XL Austin	ISOfix	right
10020876	Smartseat Easy XL Grey artificial leather	ISOfix	left
10020877	Smartseat Easy XL Grey artificial leather	ISOfix	right
0020878	Smartseat Easy XL Carmat Code	ISOfix	left
10020879	Smartseat Easy XL Carmat Code	ISOfix	right
10023343	Smartseat Easy XL MB Maturin	reclining ISOfix	left
10023344	Smartseat Easy XL MB Maturin	reclining ISOfix	left
10022773	Smartseat Easy XL Austin	reclining ISOfix	left
10022774	Smartseat Easy XL Austin	reclining ISOfix	right
10020884	Smartseat Easy XL Grey artificial leather	reclining ISOfix	left
10020885	Smartseat Easy XL Grey artificial leather	reclining ISOfix	right
110020886	Smartseat Easy XL Carmat Code	reclining ISOfix	left
10020887	Smartseat Easy XL Carmat Code	reclining ISOfix	right

The Smartseat RV M1 offers a maximum of space in the entrance area.

- Fully foldable backrest
- Integral 3-point seat belt
- Available in left-hand belt and right-hand belt models
- Height-adjustable headrest
- Various upholstery options available (including artificial leather)
- Easy to clean
- Optional: Armrest



Item Code	Item name		Shoulder belt
100023345	Smartseat RV MB Maturin	reclining to the front	left
100023345	Smartseat RV MB Maturin	reclining to the front	right
10022618	Smartseat RV M1 Grey artificial leather	reclining to the front	left
10022619	Smartseat RV M1 Grey artificial leather	reclining to the front	right
10022620	Smartseat RV M1 Black artificial leather	reclining to the front	left
10022621	Smartseat RV M1 Black artificial leather	reclining to the front	right
10022622	Smartseat RV M1 Carmat Code	reclining to the front	left
10022623	Smartseat RV M1 Carmat Code	reclining to the front	right

Smartseats

Smartseat Travel M2 and Smartseat Travel Luxury M2



Smartseat
Travel M2

The Smartseat Travel M2 and Smartseat Travel Luxury M2 are designed for maximum passenger comfort.

- Fixed or adjustable backrest
- Integral 3-point seatbelts
- Available in left-hand and right-hand models
- Alongside movable system
- M2 tested and approved by RDW, according to the newest regulation UN/ECE R14
- Various upholstery options available (including leather)
- Equipped with quick-release Smartleg supports

Available in:

- Double seat
- Single seat

Optional:

- Armrest
- Grab handles
- Foot support
- Yellow /black hand grabs
- Folding table
- Magazine net
- Yellow /black hand grabs

Please contact Smartfloor for more information and all possibilities.



Smartseat
Travel Luxury M2



Smartseat Travel M2 and Smartseat Travel Luxury M2

item code	item name		Shoulderbelt
10023815	Smartseat Travel M2 Maturin	seatleg	left
10023816	Smartseat Travel M2 Maturin	seatleg	right
10023817	Smartseat Travel M2 (double seat) Maturin	seatleg	
10023818	Smartseat Travel M2 Maturin	seatleg, reclining	left
10023819	Smartseat Travel M2 Maturin	seatleg, reclining	right
10023820	Smartseat Travel M2 (double seat) Maturin	seatleg, reclining	
10022860	Smartseat Travel M2 Carmat Code	seat leg	left
10022861	Smartseat Travel M2 Carmat Code	seat leg	right
10022862	Smartseat Travel M2, Doubleseat Carmat Code	seat leg	
10022863	Smartseat Travel M2 Grey artificial leather	seat leg, reclining	left
10022864	Smartseat Travel M2 Grey artificial leather	seat leg, reclining	right
10022865	Smartseat Travel M2 Grey artificial leather, Doubleseat	seat leg, reclining	
10022866	Fixed armrest for Travel M2	preassembled	right
10022867	Fixed armrest for Travel M2	preassembled	left
10022868	Adjustable armrest for Travel M2	preassembled	left
10022869	Adjustable armrest for Travel M2	preassembled	right
10022870	Table for Travel M2	preassembled	
10022871	Magazine net for Travel M2	preassembled	
10022872	Hand grab for Travel M2 black	preassembled	left
10022873	Hand grab for Travel M2 black	preassembled	right
10022874	Hand grab for Travel M2 yellow	preassembled	left
10022875	Hand grab for Travel M2 yellow	preassembled	right

Smartseat Luxury on request.



Mobile office foldable table

- Beautiful design
- Easy to clean
- Magazine net
- Soft close
- Movable in track
- Removable from track
- Maximum load 30 kg (per side)
- 20G tested
- Fits dedicated Smartfloor track only



item code	item name
10022840	Mobile office foldable table



Mobile office foldable side table.
The tabletop allows working for 2 people sitting opposite each other.

- Beautiful design
- Easy to clean
- Maximum load 50 kg
- Crash tested according to ECE-R17
- Head impact tested according to ECE-21
- Flexibel mouting to side wall of vehicle
- Table dimensions h= 875 x b= 720 mm
- 20G tested



item code	item name
10023748	Mobile Office Foldable Wall Table





7



PROTEKTOR-System
Wheelchair and occupant restraints



AMF-Bruns has been developing and manufacturing retractor systems for many years before all the other suppliers of restraint systems entered the market. The first 4 point system for wheelchairs and occupants was sold in the 1970's. At that time AMF-Bruns invented a wheelchair retractor to tighten the wheelchair, it was 20 years later, that others followed AMF-Bruns idea. Meanwhile the PROTEKTOR® system sets the standard worldwide - often copied, but never equalled! Of course, this knowledge and know how is still reflected in our actual restraint system.

New developments like the wheelchair adapter PROSAFE®, the monosystem, are subsequent developments of our actual system and, of course, totally compatible.

Like these, the PROTEKTOR® system gets even more easy, faster and safer to use, than any other product on the market.

To ensure ultimate safety AMF-Bruns goes further. - Good is not good enough for us!

AMF-Bruns is the world's leading company for webbing safety systems for wheelchairs and occupants. Production follows the strict rules of the ISO 9001 standard.

On top of this AMF-Bruns works permanently in different national & international meetings, has their own testing facilities and, also test at organisations like TÜV, BAST, DTC, UTAC.

The result is a proven, ultimately safe system, which meets all the requirements of its users, the PROTEKTOR® system.

STANDARDS

The AMF-Bruns PROTEKTOR® System fullfills, for example, ISO 10542-1 + 2, DIN 75078-2, CSA Z 605, FMSS/CNVSS, AS 2596, SAE J 49, 2001/85/EC.

SAFE DIVERSITY

The PROTEKTOR® occupant and wheelchair restraint system offers a number of variations.

For the installation to the vehicle floor the PROTEKTOR® System offers 4 stud fitting and mono fitting.

For the fortification on the wheelchair the system offers loops, hooks or carabiners.

Whether you use the manual **BLACKSERIES**, the automatic **SILVERSERIES** or the heavy duty **PLATINUMSERIES**, the PROTEKTOR® System offers proven safety according to ISO 10542, regardless of what variations you choose.

Simply choose the System that best suits your needs.





BLACKSERIES

- manual pull-out and semi automatic self-tensioning system
- lightweight ABS-Cover



PROTEKTOR-System

BLACKSERIES

RETRACTOR SYSTEM WITH LOOP

4 STUD FITTING AT 40°, FLEXIBLE



**Protektor®-System
Pro 2 B LV with loop
and 4 stud fitting at 40°, flexible**

- 2 x retractor belt LV
- 2 x static belt LV
- 1 x pelvis belt

Item-No. H 350 502 LV

7

**Protektor®-System
Pro 4 B LV with loop
and 4 stud fitting at 40°, flexible**

- 4 x retractor belt LV
- 1 x pelvis belt

Item-No. H 350 504 LV

4 STUD FITTING TWISTED 40/90°, FLEXIBLE

**Protektor®-System
Pro 2 B LG with loop and 4 stud
fitting twisted 40/90°, flexible**

- 2 x retractor belt LG
- 2 x static belt LV
- 1 x pelvis belt

Item-No. H 350 502 LG

**Protektor®-System
Pro 4 B LG with loop and 4 stud
fitting twisted 40/90°, flexible**

- 4 x retractor belt LG
- 1 x pelvis belt

Item-No. H 350 504 LG

4 STUD FITTING FLAT FLEXIBLE



Protector®-System
Pro 2 B LF with loop and 4 stud fitting, flat flexible

- 2 x retractor belt LF
- 2 x static belt LV
- 1 x pelvis belt

Item-No. H 350 502 LF

Protector®-System
Pro 4 B LF with loop and 4 stud fitting, flat flexible

- 4 x retractor belt LF
- 1 x pelvis belt

Item-No. H 350 504 LF

MONO FITTING AT 40°



Protector®-System
Pro 2 B LM with loop and Mono fitting at 40°

- 2 x retractor belt LM
- 2 x static belt LM
- 1 x pelvis belt

Item-No. H 350 502 LM

Protector®-System
Pro 4 B LM with loop and Mono fitting at 40°

- 4 x retractor belt LM
- 1 x pelvis belt

Item-No. H 350 504 LM

RETRACTOR SYSTEM WITH HOOK

4 STUD FITTING AT 40°, FLEXIBLE



Protector®-System
Pro 2 B HV with hook and 4 stud fitting at 40°, flexible

- 2 x retractor belt HV
- 2 x static belt HV
- 1 x pelvis belt

Item-No. H 350 522 HV

4 STUD FITTING AT 40°, FLEXIBLE



**Protektor®-System
Pro 4 B HV with hook and
4 stud fitting at 40°, flexible**

- 4 x retractor belt HV
- 1 x pelvis belt

Item-No. H 350 524 HV

4 STUD FITTING TWISTED AT 40/90°, FLEXIBLE



**Protektor®-System
Pro 2 B HG with hook and
4 stud fitting twisted 40/90°, flexible**

- 2 x retractor belt HG
- 2 x static belt HV
- 1 x pelvis belt

Item-No. H 350 522 HG

7



**Protektor®-System
Pro 4 B HG with hook and
4 stud fitting twisted 40/90°, flexible**

- 4 x retractor belt HG
- 1 x pelvis belt

Item-No. H 350 524 HG



**Protektor®-System
Pro 2 B HF with hook and
4 stud fitting, flat flexible**

- 2 x retractor belt HF
- 2 x static belt HV
- 1 x pelvis belt

Item-No. H 350 522 HF



**Protektor®-System
Pro 4 B HF with hook and
4 stud fitting, flat flexible**

- 4 x retractor belt HF
- 1 x pelvis belt

Item-No. H 350 524 HF

4 STUD FITTING FLAT FLEXIBLE



**Protektor®-System
Pro 2 B HM with hook and
Mono fitting at 40°**

- 2 x retractor belt HM
- 2 x static belt HM
- 1 x pelvis belt

Item-No. H 350 522 HM



**Protektor®-System
Pro 4 B HM with hook
and Mono fitting at 40°**

- 4 x retractor belt HM
- 1 x pelvis belt

Item-No. H 350 524 HM

RETRACTOR SYSTEM WITH CARABINER

4 STUD FITTING FLAT FLEXIBLE



**Protektor®-System
Pro 2 B CV with carabiner
and 4 stud fitting at 40°, flexible**

- 2 x retractor belt CV
- 2 x static belt CV
- 1 x pelvis belt

Item-No. H 350 552 CV



**Protektor®-System
Pro 4 B CV with carabiner
and 4 stud fitting at 40°, flexible**

- 4 x retractor belt CV
- 1 x pelvis belt

Item-No. H 350 554 CV

4 STUD FITTING 40/90°, FLEXIBLE



**Protektor®-System
Pro 2 B CG with carabiner and
4 stud fitting twisted 40/90°, flexible**

- 2 x retractor belt CG
- 2 x static belt CV
- 1 x pelvis belt

Item-No. H 350 552 CG

4 STUD FITTING TWISTED AT 40/90°, FLEXIBLE



Protector®-System
Pro 4 B CG with carabiner
and 4 stud fitting twisted 40/90°,
flexible

- 2 x retractor belt CG
- 2 x static belt CV

Item-No. H 350 554 CG

4 STUD FITTING FLAT FLEXIBLE



Protector®-System
Pro 2 B CF with carabiner
and 4 stud fitting, flat flexible

- 2 x retractor belt CF
- 2 x static belt CV
- 1 x pelvis belt

Item-No. H 350 552 CF

7



Protector®-System
Pro 4 B CF with carabiner
and 4 stud fitting, flat flexible

- 4 x retractor belt CF
- 1 x pelvis belt

Item-No. H 350 554 CF

MONO FITTING 40°



Protector®-System
Pro 2 B CM with carabiner
and Mono fitting at 40°

- 2 x retractor belt CM
- 2 x static belt CM
- 1 x pelvis belt

Item-No. H 350 552 CM



Protector®-System
Pro 4 B CM with carabiner
and Mono fitting at 40°

- 4 x retractor belt CM
- 1 x pelvis belt

Item-No. H 350 554 CM

RETRACTOR WITH LOOP



Retractor B LV
with loop and
4 stud fitting at 40°,
flexible

Item-No.
H 350 509 LV



Retractor B LG
with loop and
4 stud fitting
twisted 40/90°,
flexible

Item-No.
H 350 509 LG



Retractor B LF
with loop and
4 stud fitting,
flat flexible

Item-No.
H 350 509 LF



Retractor B LM
with loop and
Mono fitting at 40°

Item-No.
H 350 509 LM

RETRACTOR WITH HOOK



Retractor B HV
with hook and
4 stud fitting
at 40°, flexible

Item-No.
H 350 534 HV



Retractor B HG
with hook and
4 stud fitting
twisted 40/90°, flexible

Item-No.
H 350 534 HG



Retractor B HF
with hook and
4 stud fitting
flat flexible

Item-No.
H 350 534 HF



Retractor B HM
with hook and
Mono fitting at 40°

Item-No.
H 350 534 HM

RETRACTOR WITH CARABINER



Retractor B CV
with carabiner and
4 stud fitting
at 40°, flexible

Item-No.
H 350 564 CV



Retractor B CG
with carabiner and
4 stud fitting
twisted 40/90°, flexible

Item-No.
H 350 564 CG



Retractor B CF
with carabiner and
4 stud fitting,
flat flexible

Item-No.
H 350 564 CF



Retractor B CM
with carabiner and
Mono fitting at 40°

Item-No.
H 350 564 CM

STATIC BELTS

STATIC BELT WITH 4 STUD FITTING



Static belt LV
with loop
and 4 stud fitting
(front attachment)

Item-No.
H 350 510 LV



Static belt HV
with hook
and 4 stud fitting
(front attachment)

Item-No.
H 350 535 HV



Static belt CV
with carabiner
and 4 stud fitting
(front attachment)

Item-No.
H 350 565 CV

STATIC BELTS

STATIC BELT WITH MONO FITTING



Static belt LM
with loop
and Mono fitting
(front attachment)

Item-No.
H 350 510 LM



Static belt HM
with hook
and Mono fitting
(front attachment)

Item-No.
H 350 535 HM



Static belt CM
with carabiner
and Mono fitting
(front attachment)

Item-No.
H 350 565 CM

ELECTRIC BELTS



Electric belt L
with loop,
length 3,6 m
(front attachment)

Item-No.
H 350 240 L

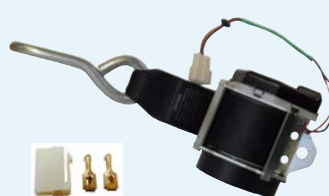

Electric belt H
with hook,
length 3,6 m
(front attachment)

Item-No.
H 350 240 H



Electric belt C
with carabiner,
length 3,6 m
(front attachment)

Item-No.
H 350 240 C

Zinc high pressure die casting
cover for electric belt complete
cover (front attachment)

Item-No.
H 350 257



PROTEKTOR-System
Wheelchair and occupant restraints

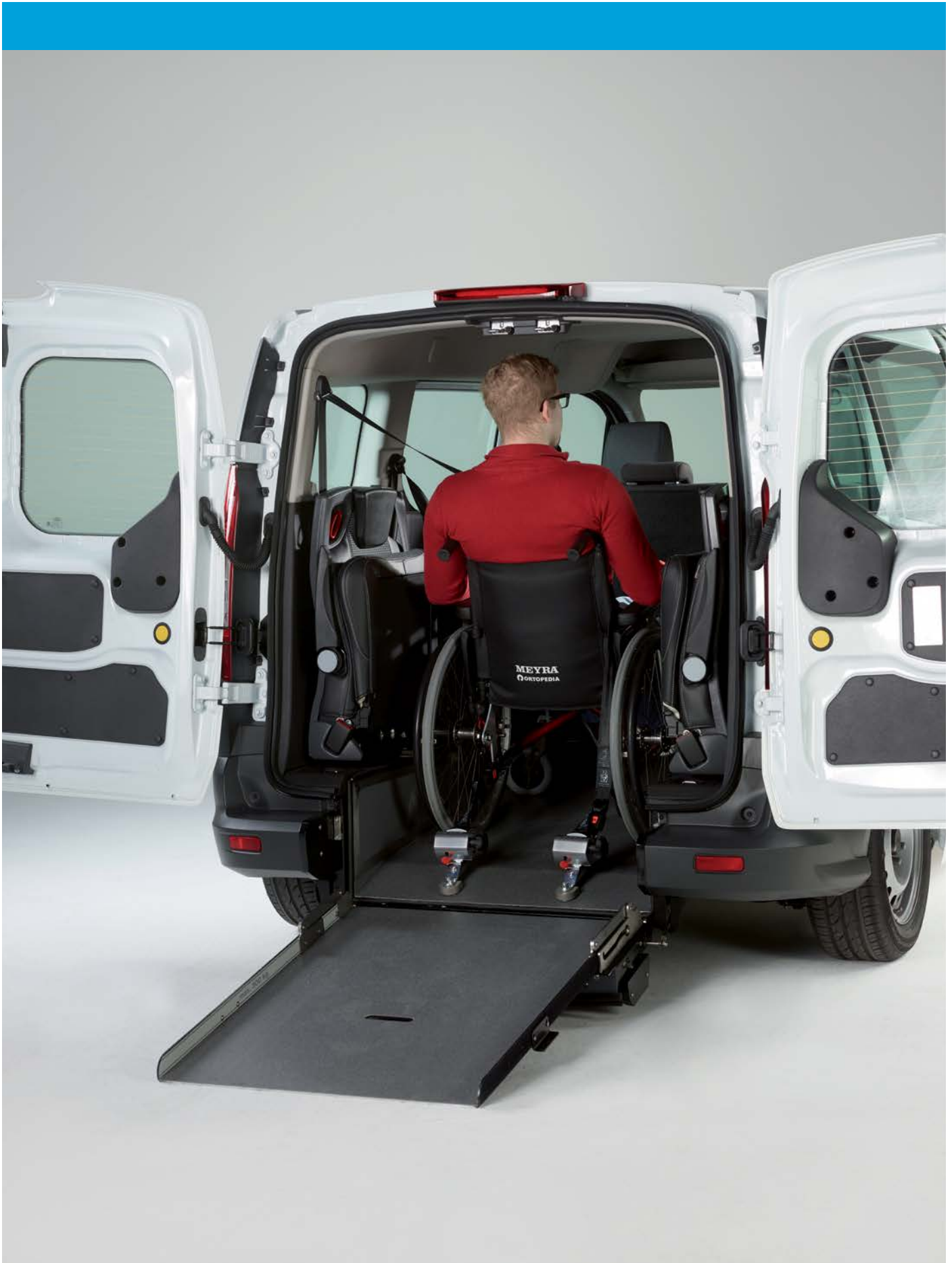



SILVERSERIES

The ISO 10542 tested **SILVERSERIES** has a fully automatic pull-out and self-tensioning system. Its robust zinc diecasting cover is suitable for daily use in the vehicle.



PROTEKTOR-System

SILVERSERIES

WHEELCHAIR RESTRAINT SYSTEM

General note!
Static belt only for front attachment.

RETRACTOR SYSTEM WITH LOOP

4 STUD FITTING AT 40°, FLEXIBLE



Protektor®-System
Pro 2 S LV with loop
and 4 stud fitting
at 40°, flexible

- 2 x retractor belt LV
- 2 x static belt LV
- 1 x pelvis belt

Item-No. H 350 501 LV



Protektor®-System
Pro 4 S LV with loop
and 4 stud fitting
at 40°, flexible

- 4 x retractor belt LV
- 1 x pelvis belt

Item-No. H 350 503 LV

4 STUD FITTING TWISTED 40/90°, FLEXIBLE



Protektor®-System
Pro 2 S LG with loop
and 4 stud fitting twisted
40/90°, flexible

- 2 x retractor belt LG
- 2 x static belt LV
- 1 x pelvis belt

Item-No. H 350 501 LG

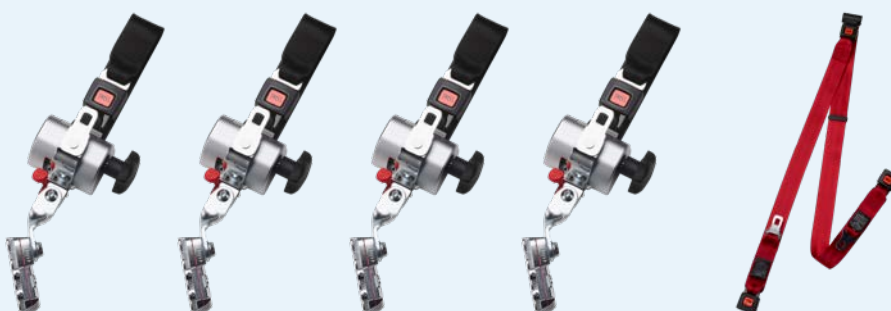

Protektor®-System
Pro 4 S LG with loop
and 4 stud fitting twisted
40/90°, flexible

- 4 x retractor belt LG
- 1 x pelvis belt

Item-No. H 350 503 LG

4 STUD FITTING, FLAT FLEXIBLE



**Protector®-System
Pro 2 S LF with loop
and 4 stud fitting,
flat flexible**

- 2 x retractor belt LF
- 2 x static belt LV
- 1 x pelvis belt

Item-No. H 350 501 LF

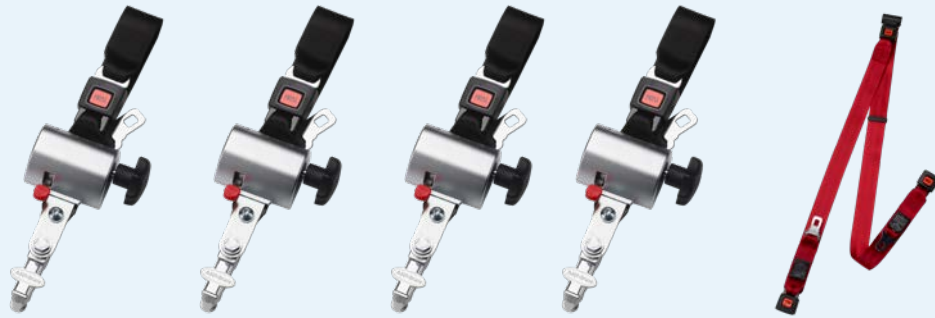

**Protector®-System
Pro 4 S LF with loop
and 4 stud fitting,
flat flexible**

- 4 x retractor belt LF
- 1 x pelvis belt

Item-No. H 350 503 LF

MONO FITTING AT 40°



**Protector®-System
Pro 2 S LM with loop
and Mono fitting at 40°**

- 2 x retractor belt LM
- 2 x static belt LM
- 1 x pelvis belt

Item-No. H350 501 LM



**Protector®-System
Pro 4 S LM with loop
and Mono fitting at 40°**

- 4 x retractor belt LM
- 1 x pelvis belt

Item-No. H 350 503 LM

RETRACTOR SYSTEM WITH HOOK

4 STUD FITTING 40°, FLEXIBLE



**Protector®-System
Pro 2 S HV with hook
and 4 stud fitting
at 40°, flexible**

- 2 x retractor belt HV
- 2 x static belt HV
- 1 x pelvis belt

Item-No. H 350 520 HV

4 STUD FITTING 40°, FLEXIBLE



Protektor®-System
Pro 4 S HV with hook
and 4 stud fitting
at 40°, flexible

- 4 x retractor belt HV
- 1 x pelvis belt

Item-No. H350 525 HV

4 STUD FITTING TWISTED 40/90°, FLEXIBLE

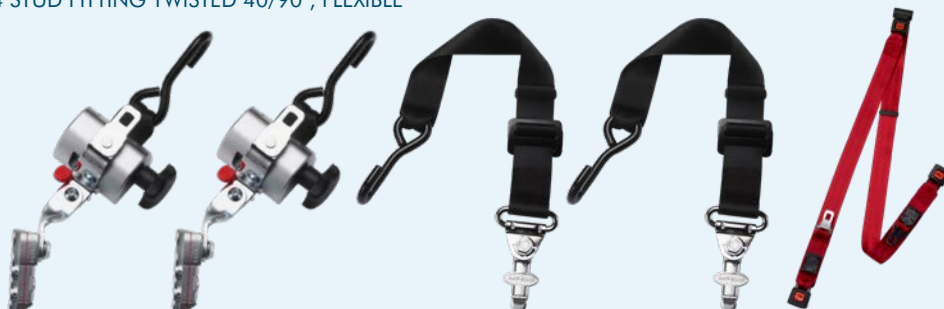

Protektor®-System
Pro 2 S HG with hook
and 4 stud fitting twisted
40/90°, flexible

- 2 x retractor belt HG
- 2 x static belt HV
- 1 x pelvis belt

Item-No. H 350 520 HG

4 STUD FITTING TWISTED 40/90°, FLEXIBLE



Protektor®-System
Pro 4 S HG with hook
and 4 stud fitting twisted
40/90°, flexible

- 4 x retractor belt HG
- 1 x pelvis belt

Item-No. H 350 525 HG

4 STUD FITTING, FLAT FLEXIBLE



Protektor®-System
Pro 2 S HF with hook
and 4 stud fitting,
flat flexible

- 2 x retractor belt HF
- 2 x static belt HV
- 1 x pelvis belt

Item-No. H 350 520 HF

4 STUD FITTING, FLAT FLEXIBLE



Protektor®-System
Pro 4 S HF with hook
and 4 stud fitting,
flat flexible

- 4 x retractor belt
- 1 x pelvis belt

Item-No. H 350 525 HF

MONO FITTING AT 40°



Protektor®-System
Pro 2 S HM with hook
and Mono fitting at 40°

- 2 x retractor belt HM
- 2 x static belt HM
- 1 x pelvis belt

Item-No. H 350 520 HM



Protektor®-System
Pro 4 S HM with hook
and Mono fitting at 40°

- 4 x retractor belt HM
- 1 x pelvis belt

Item-No. H 350 525 HM

RETRACTOR SYSTEM WITH CARABINER

4 STUD FITTING 40°, FLEXIBLE



Protektor®-System
Pro 2 S CV with carabiner
and 4 stud fitting at 40°, flexible

- 2 x retractor belt CV
- 2 x static belt CV
- 1 x pelvis belt

Item-No. H 350 550 CV



Protektor®-System
Pro 4 S CV with carabiner
and 4 stud fitting at 40°, flexible

- 4 x retractor belt CV
- 1 x pelvis belt

Item-No. H350 555 CV

4 STUD FITTING TWISTED 40/90°, FLEXIBLE



Protektor®-System
Pro 2 S CG with carabiner
and 4 stud fitting twisted
40/90°, flexible

- 2 x retractor belt CG
- 2 x static belt CV
- 1 x pelvis belt

Item-No. H 350 550 CG

4 STUD FITTING TWISTED 40/90°, FLEXIBLE



Protektor®-System
Pro 4 S CG with carabiner
and 4 stud fitting twisted
40/90°, flexible

- 4 x retractor belt CG
- 1 x pelvis belt

Item-No. H 350 555 CG

4 STUD FITTING, FLAT FLEXIBLE



Protektor®-System
Pro 2 S CF with carabiner
and 4 stud fitting,
flat flexible

- 2 x retractor belt CF
- 2 x static belt CV
- 1 x pelvis belt

Item-No. H 350 550 CF

7



Protektor®-System
Pro 4 S CF with carabiner
and 4 stud fitting,
flat flexible

- 4 x retractor belt CF
- 1 x pelvis belt

Item-No. H 350 555 CF

MONO FITTING AT 40°



Protektor®-System
Pro 2 S CM with carabiner
and Mono fitting at 40°

- 2 x retractor belt CM
- 2 x static belt CM
- 1 x pelvis belt

Item-No. H 350 550 CM



Protektor®-System
Pro 4 CM with carabiner
and Mono fitting at 40°

- 4 x retractor belt CM
- 1 x pelvis belt

Item-No. H 350 555 CM

RETRACTOR WITH LOOP



Retractor S LV
with loop and
4 stud fitting
at 40°, flexible

Item-No.
H 350 505 LV



Retractor S LG
with loop and
4 stud fitting
twisted 40/90°, flexible

Item-No.
H 350 505 LG



Retractor S LF
with loop and
4 stud fitting,
flat flexible

Item-No.
H 350 505 LF



Retractor S LM
with loop
and Mono fitting
at 40°

Item-No.
H 350 505 LM

RETRACTOR WITH HOOK

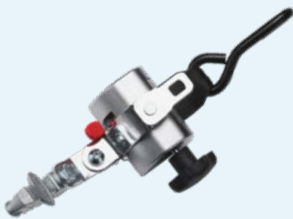

Retractor S HV
with hook and
4 stud fitting
flexible at 40°

Item-No.
H 350 530 HV



Retractor S HG
with hook and
4 stud fitting
twisted, 40/90°, flexible

Item-No.
H 350 530 HG

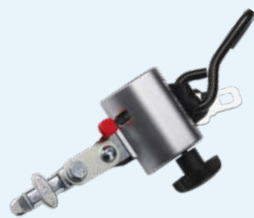

Retractor S HF
with hook and
4 stud fitting,
flat flexible

Item-No.
H 350 530 HF



Retractor S HM
with hook
and Mono fitting
at 40°

Item-No.
H 350 530 HM

RETRACTOR WITH CARABINER

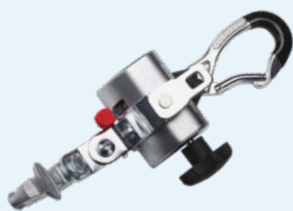

Retractor S CV
with carabiner and
4 stud fitting
flexible at 40°

Item-No.
H 350 560 CV



Retractor S CG
with carabiner and
4 stud fitting
twisted 40/90°, flexible

Item-No.
H 350 560 CG

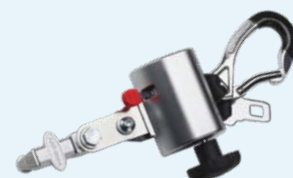

Retractor S CF
with carabiner and
4 stud fitting,
flat flexible

Item-No.
H 350 560 CF



Retractor S CM
with carabiner
and Mono fitting
at 40°

Item-No.
H 350 560 CM

STATIC BELTS

STATIC BELT WITH 4 STUD FITTING



Static belt LV
with loop
and 4 stud fitting
(front attachment)

Item-No.
H 350 510 LV



Static belt HV
with hook
and 4 stud fitting
(front attachment)

Item-No.
H 350 535 HV



Static belt CV
with carabiner
and 4 stud fitting
(front attachment)

Item-No.
H 350 565 CV

STATIC BELTS

STATIC BELT WITH MONO FITTING



Static belt LM
with loop
and Mono fitting
(front attachment)

Item-No.
H 350 510 LM



Static belt HM
with hook
and Mono fitting
(front attachment)

Item-No.
H 350 535 HM



Static belt CM
with carabiner
and Mono fitting
(front attachment)

Item-No.
H 350 565 CM

ELECTRIC BELTS



Electric belt L
with loop,
length 3,6 m
(front attachment)

Item-No.
H 350 240 L



Electric belt H
with hook,
length 3,6 m
(front attachment)

Item-No.
H 350 240 H



Electric belt C
with carabiner,
length 3,6 m
(front attachment)

Item-No.
H 350 240 C

Zinc high pressure die casting
cover for electric belt complete
cover (front attachment)

Item-No.
H 350 257



PROTEKTOR-System
Wheelchair and occupant restraints





PLATINUMSERIES HEAVY DUTY HD160



Wheelchair Restraint System

Increased weight requirements for electric wheelchairs and wheelchair users have created the need for a new wheelchair restraint system for heavier loads. AMF-Brunns developed the new Protektor Platinum Series after intensive crash tests indicated the need for more durable retractors. The Platinum Series is a heavy duty 4 point wheelchair retractor system for wheelchairs and occupants. This wheelchair restraint system can support loads up to 160 kgs (also for wheelchairs with integrated lap belt) – creating a new level of security!



These facts make all the difference

- Applicable up to 160 kg – also for wheelchairs with integrated lap belt.
- 4 point securement system
- Easy to use
- Robust design
- Fulfills ISO 10542, WC18 and DIN 75078 with integrated lap belt
- The **PLATINUM**SERIES is compatible with all wheelchairs and vehicles
- The **PLATINUM**SERIES is equipped with carabiners, which ensure a safe connection between wheel-chair and vehicle, even if the wheelchair deforms during an accident.

PLATINUMSERIES

WHEELCHAIR RESTRAINT SYSTEM

RETRACTOR SYSTEM WITH LOOP

4 STUD FITTING AT 40°, FLEXIBLE



Protektor® System
Pro 4 P LV with loop and
4 stud fitting at 40°, flexible

- 4 x retractor belt LV
- 1 x pelvis belt

Item no. H 350 815 LV

MONO FITTING AT 40°



Protektor® System
Pro 4 P LM with loop and
Mono fitting at 40°

- 4 x retractor belt LM
- 1 x pelvis belt

Item no. H 350 815 LM

RETRACTOR SYSTEM WITH HOOK

4 STUD FITTING AT 40°, FLEXIBLE

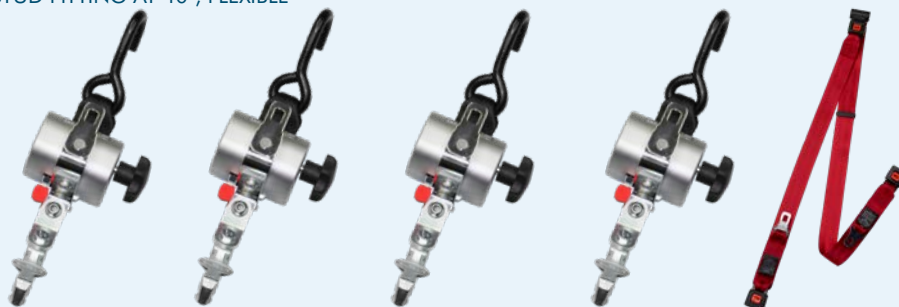

Protektor® System
Pro 4 P HV with hook and 4
stud fitting at 40°, flexible

- 4 x retractor belt HV
- 1 x pelvis belt

Item no. H 350 815 HV

MONO FITTING AT 40°



Protektor® System
Pro 4 P HM with hook and
Mono fitting at 40°

- 4 x retractor belt HM
- 1 x pelvis belt

Item no. H 350 815 HM

RETRACTOR SYSTEM WITH CARABINER

4 STUD FITTING 40°, FLEXIBLE

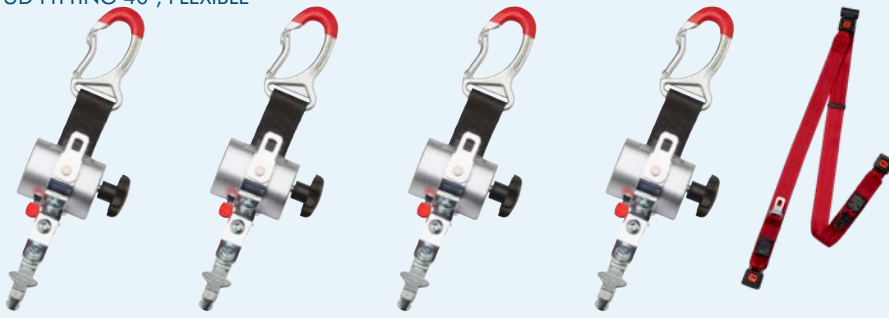

Protektor® System Pro 4 P CV with carabiner and 4 stud fitting at 40°, flexible

- 4 x retractor belt CV
- 1 x pelvis belt

Item no. H 350 815 CV

MONO FITTING AT 40°



Protektor® System Pro 4 P CM with carabiner and Mono fitting at 40°

- 4 x retractor belt CM
- 1 x pelvis belt

Item no. H 350 815 CM

RETRACTORS

RETRACTOR WITH LOOP



Retractor P LV with loop and 4 stud fitting flexible at 40°

Item no. H 350 800 LV



Retractor P LM with loop and mono fitting at 40°

Item no. H 350 800 LM

RETRACTOR WITH HOOK



Retractor P HV with hook and 4 stud fitting flexible at 40°

Item no. H 350 800 HV



Retractor P HM with hook and mono fitting at 40°

Item no. H 350 800 HM

RETRACTOR WITH CARABINER



Retractor P CV with carabiner and 4 stud fitting at 40°, flexible

Item no. H 350 800 CV

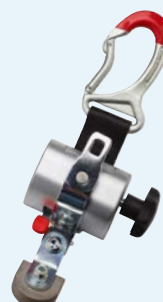

Retractor P CM with carabiner and Mono fitting at 40°

Item no. H 350 800 CM



Occupant restraints



OCCUPANT RESTRAINT SYSTEM



Static
shoulder belt
with buckle,
two part

Item-No.
H 350 227



Pelvis belt

Standard length
Item-No.
H 350 200

XL Version
Item-No.
H 350 198



Automatic
pelvis belt with
flexible buckle

Item-No.
H 350 205



Automatic
pelvis belt

Item-No.
H 350 207



Flexible buckle
length 300 mm

Item-No.
H 350 210



Automatic
shoulder belt
without height
adjustment

Item-No.
H 350 225



Automatic
shoulder belt
(height adjustable)

Item-No.
H 350 235



Automatic shoulder belt
without height adjust-
ment incl. two 4 stud
fittings

Item-No.
H 350 250



Automatic shoulder belt
with height
adjustment
incl. two 4 stud
fittings

Item-No.
H 350 239



Static
shoulder belt

Item-No.
H 350 226

OCCUPANT RESTRAINT SYSTEM



Automatic 3 point shoulder belt with retractor height-adjustment

Item no. H 350 255



Automatic 3-Point-Belt with height adjustment incl. tongue

Item-No. H 350 231



Automatic 3 point belt without height adjustment

Item-No. H 350 230



Automatic 3-Point-Belt without height adjustment incl. two 4 stud fittings

Item-No. H 350 251



Automatic 3-Point-Belt with height adjustment incl. two 4 stud fittings

Item-No. H 350 252



WAV Automatic 3-Point-Belt with height adjustment and two flexible buckles, 300 mm

Item-No. H 350 233



WAV Automatic 3-Point-Belt without height adjustment and two flexible buckles, 300 mm
Item-No. H 350 232



Harness belt (only in combination with shoulder belt)

Item-No. 350 222

ACCESSORIES



Headrest

W 330 - 410 mm
Item-No. H 150 259

W 400 - 480 mm
Item-No. H 150 258



Secure belt 300 mm

Item-No. H 350 238

FLOOR SYSTEMS

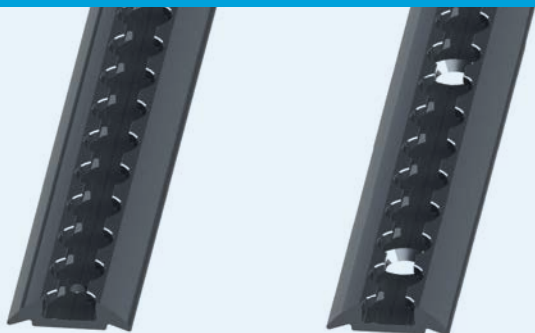

Protektor® Surface track

not predrilled
 1000 mm length Item-No. H 150 132
 1500 mm length Item-No. H 150 134
 1750 mm length Item-No. H 150 135
 3000 mm length Item-No. H 150 136

predrilled
 3000 mm length Item-No. H 150 385

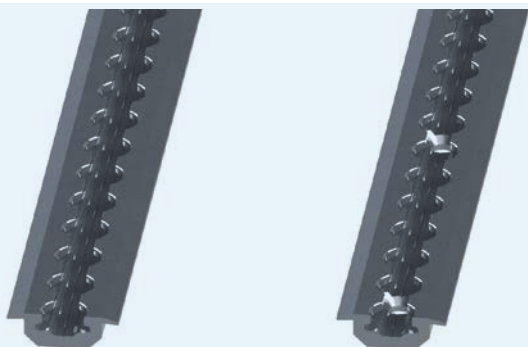

Protektor® Insert track

not predrilled
 1750 mm length Item-No. H 150 120
 3500 mm length Item-No. H 150 130

predrilled
 3500 mm length Item-No. H 150 375



Mono fitting (complete)

Item-No.
 H 150 915
 with Bolt M12
 50 mm



Mono fitting (head piece)

Item-No.
 H 150 916
 with Bolt M12
 50 mm



Mono fitting with 40°

Item-No.
 H 150 619



Monodisc (floor)
 Chassis reinforcement
 kits available, please
 ask for details.

Item-No.
 H 150 917
 with Bolt M12
 50 mm



ACCESSORIES



Easy-Bag
for restraint system

Item-No.
10019363



Storage box
167.5 x 690 x 383.5 mm

Item-No.
10012744



Breast belt
180 cm length
160 cm length
110 cm length

Item-No. H 150 222
Item-No. H 150 223
Item-No. H 150 224



Storage box
180 x 840 x 480 mm

Item-No.
10012270



Black grab handle

Item-No.
10008015

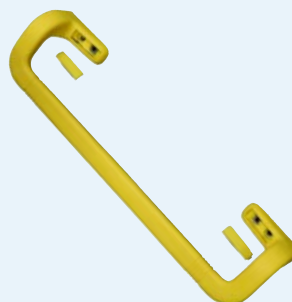

Yellow grab handle

Item-No.
10008016



Interior paneling back
and side loading door
VW Crafter/
MAN TGE

Item-No.
10023062



Rubber plugs
VW Crafter/
MAN TGE

Item-No.
(L2) 10023061
(L3) 10022913



Duct system Ford
Transit Custom

Item-No.
10019740

20001126
Lugagehook





Floor pocket
Chassis reinforcement
kits available, please
ask for details.

Item no.
200269390



4 stud fitting

Item-No.
2002 11247



4 stud fitting
with bolt

Item-No.
H 150 615



4 stud fitting 40° bracket

Item-No.
H 150 616



4 stud fitting
twisted 40°/90°

Item-No.
H 150 617



4 stud fitting
flat

Item-No.
H 150 618

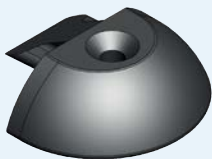

End cap for
surface track

Item-No.
200 261 878

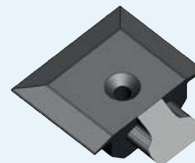
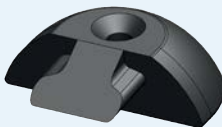

End cap for
insert track

Item-No.
200 261 840

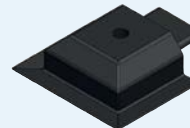

Mono disc Back
(incl. U-profile)

Item-No.
200309251

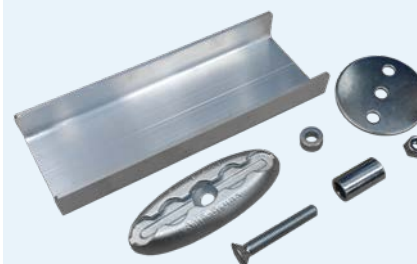

Floor pocket Back
(incl. U-profile)

Item-No.
200309340

Protector
Head and Back rest/seat belt anchorage



8



Back and head support

Smartfloor includes two special back and head support constructions to provide the best possible protection of the back and head of a wheelchair occupant in the event of an accident during transport. Both constructions are suitable for mounting to the floor in an airline rail and flexible in their application at any desired location in the vehicle.



Fixed third belt point

Smartfloor delivers a special 3-point shoulder belt for vehicles that are fitted with an airline guide rail mounted in the top side of the vehicle. By means of this rail, a third belt point can be easily created throughout the interior of the vehicle. The advantage is that the vehicle, in combination with a Smartfloor, meets ISO 10542 standards. Delivery options include either a fixed belt or an auto-retractable belt.

Standard sets

Smartfloor supplies the AMF Protektor in standard sets inclusive of a red, static hip belt. Depending on the options selected, the sets are fitted with either 2 or 4 retractors, safety belt lock or stainless steel open hooks for attachment to the wheelchair. Options further include a static 3-point shoulder belt or a 3-point auto-retractable shoulder belt. For a complete list of all available sets, see the table on the next page.

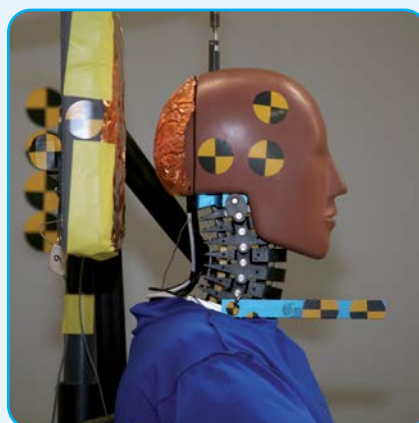
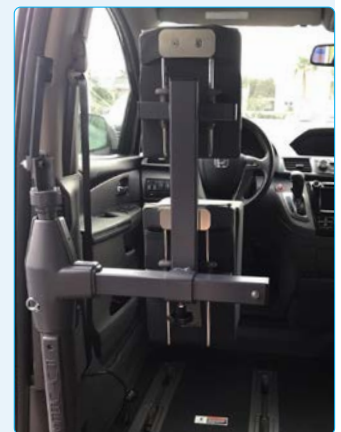

EASYPULL
Winch & Front Restraint System

The fully integrated wheelchair restraint system acc. ISO 10542 and DIN 75078-2 Standards with automatic winch function. Compatible with EMC (electro magnetic compatibility) in accordance with the European legislation.



Specification

- Easy operation
- Wireless remote control
- Audible signal when belt straps are securely locked
- 4 m belt length
- Easy installation
- Compact design
- 2 speed levels
- 20 G crash tested
- ISO 10542 tested
- Individually adjustable end position of the wheelchair inside the vehicle

TECHNICAL DATA

Load Capacity (SWL): 160 kg
 Control: via push buttons
 Power: electrical, 12 V
 Installation: retrofittable

ITEM CODE	ITEM NAME
H350300L	EasyPull with Loop
H350300H	EasyPull with Hook

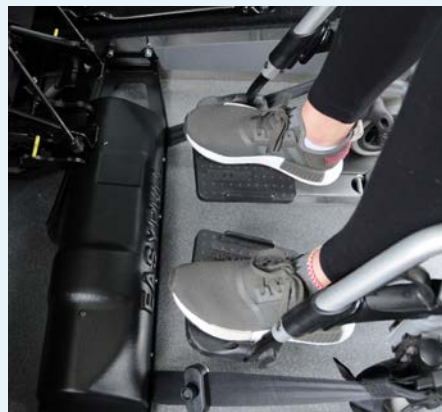
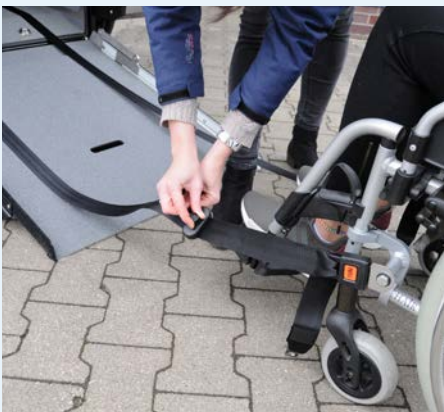

RAIL SOLUTION

VEHICLE APPROVED ANCHORAGE POINTS FOR OCCUPANT RESTRAINTS

According to EU directive 2007/46/EG (214/2014 Annex XI, 3) – mandatory in European countries

UPPER ANCHORAGE POINTS

All AMF-Bruns occupant restraint systems – whether static or automatic shoulder belts in combination with a separate pelvis belt or integrated 3 point belt – have been tested with 24.5 kN forwards and 8.2 kN backwards. AMF-Bruns has developed and produces special assembly kits for each vehicle. The pull tests are carried out in our own test centre in cooperation with TÜV. The assembly kits are compatible with all AMF-Bruns restraint systems.

AMF-BRUNS PROTEKTOR® WHEELCHAIR AND OCCUPANT RESTRAINT SYSTEM FULFILLS THE EU DIRECTIVE 2007/46/EG WHICH CAME INTO FORCE ON 1ST NOVEMBER 2014.

ATTENTION!

The vehicle manufacturer’s body fitting guidelines must be adhered to and AMF-Bruns original parts need to be used for the installation!

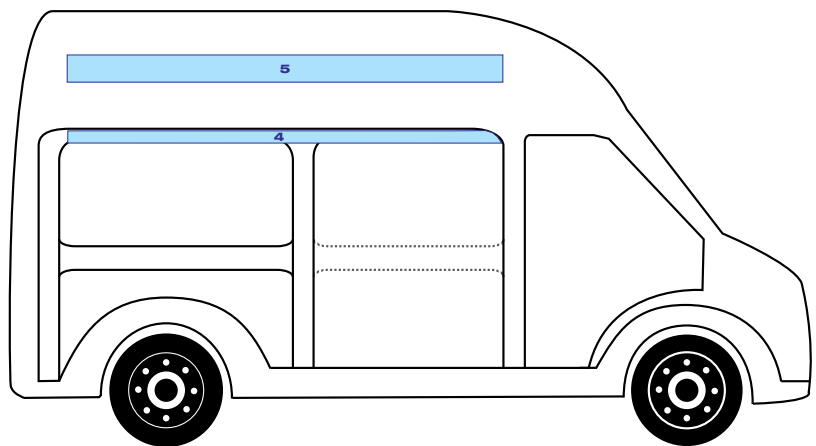

Vehicle Model without Trim	Area	Assembly material Mounting rail 1 m	Assembly material Mounting rail 3 m	Mounting rail 1 m	Mounting rail 3 m
Peugeot Boxer / Fiat Ducato Citroen Jumper	4	1001 9571	1001 9572	H150 132	H150 136
Ford Transit	4	1001 9578	1001 9579	H150 132	H150 136
Nissan NV400 / Opel Movano	4	1001 9578	1001 9579	H150 132	H150 136
Renault Master	5	1001 9578	1001 9579	H150 132	H150 136
Volkswagen Crafter (old)	4	1001 9680	1001 9681	H150 132	H150 385
Mercedes-Benz Sprinter	4	1001 9680	1001 9681	H150 132	H150 385
Volkswagen T5 / T6	4	1001 9578	1001 9579	H150 132	H150 136

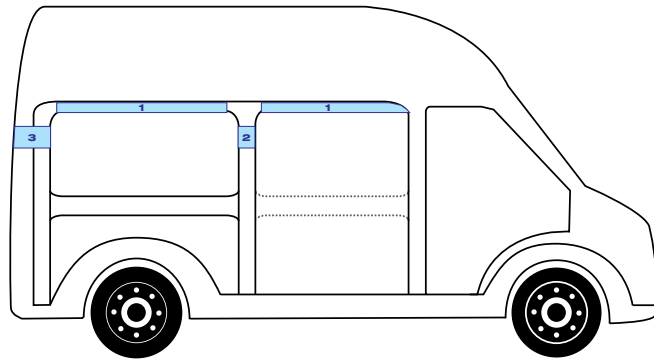

Vehicle Model	Area	Part No. with Trim	Part No. without Trim
Peugeot Boxer/ Fiat Ducato	1	1001 9565	1001 9564
Citroen Jumper	2	1001 9564	1001 9564
	3	1001 9563	1001 9562
Citroen Spacetourer, Peugeot Traveller, Toyota Proace	2	-	10023562
	2	-	10023562
Ford Transit F7 (V363)	1	1001 9665	1001 9665
	2	1001 9574	1001 9574
	3	1001 9564	1001 9564
Ford Transit Custom	1	1001 9564	1001 9564
	2	1001 9573	1001 9573
	3	1001 9574	1001 9574
Volkswagen Crafter (new) / MAN TGE	1	1001 9564	1001 9564
	2	1001 9573	1001 9573
	3	1001 9574	1001 9574
Mercedes-Benz Vito	2	1001 9679	1001 9679
	3	1001 9678	1001 9679
Volkswagen Crafter (old)	1	1001 9676	1001 9676
Mercedes-Benz Sprinter	1	1001 9676	1001 9676
Nissan NV300 / Opel Vivaro	1	1001 9564	1001 9564
Renault Trafic / Fiat Talento	2	1001 9564	1001 9564
	3	1001 9574	1001 9574
Nissan NV400 / Opel Movano Master	1	1001 9577	1001 9576
	2	1001 9564	1001 9564
	3	1001 9562	1001 9562
Volkswagen T6	1*	1001 9574	1001 9574
	2	1001 9574	1001 9574
Volkswagen Crafter (new) MAN TGE	1	1002 3278	1002 3278
	1	1002 3278	1002 3278

* Only Transporter and Kombi

FOR PASSIVE DRIVERS



AMF-Bruns provides tested head and backrest for wheelchair users. Only AMF-Bruns possesses patented 20 G front impacted and 10 G rear impacted head & back supports.

- Maximum confidence
- Reliable, space-saving and comfortable
- Complies with dynamic crash tests (Euro-NCAP 10 G rear-end collision)
- Suitable for minibuses and cut floor vehicles
- Includes approved integrated 2-point shoulder belt
- Height-adjustable – fits different wheelchairs
- Easy to handle in the vehicle
- Separate, 180° rotatable head- and back support
- Optional: On lockable for Smartfloor application (easy removable)
- The FutureSafe floor mounted i.c.w. Smartfloor is a TÜV tested solution for shoulderbelt use.



Floor mounted

With the easy to use head- and backrest FUTURESAFE®, AMF-Bruns is setting a new standard of safety.

- Various crashtests show clearly: FUTURESAFE® ensures the highest level of safety in case of a rear impact.
- On the top of this the integrated shoulderbelt ensures the essential safety in case of a front impact.
- FUTURESAFE® - The only incorporated safety system with head- and backrest.

Item code

Item name

10019544	FutureSafe Floor mounted left, Shoulder belt without height adjustable
10019543	FutureSafe Floor mounted left, Shoulder belt with height adjustable
10019546	FutureSafe Floor mounted right, Shoulder belt without height adjustable
10019545	FutureSafe Floor mounted right, Shoulder belt with height adjustable
10011173	FutureSafe Quick lock AMF lockable for Smartfloor application

FOR ACTIVE DRIVERS

Specification

- Maximum assurance, 15 G crash tested
- Height-adjustable – fits different wheelchairs
- 90° rotatable head and back support
- Single solution for active drivers on market according to ISO 10542, Part M
- Easy to operate in the vehicle via a switch on the dashboard
- Compatible with EMC in accordance with the European legislation
- Available for Volkswagen T6 and Mercedes-Benz V-Class



Item code	Item name
-----------	-----------

200406060	eFutureSafe Head & Backrest for LHD
-----------	-------------------------------------

Floor covering
Floor covering Altro Transflor

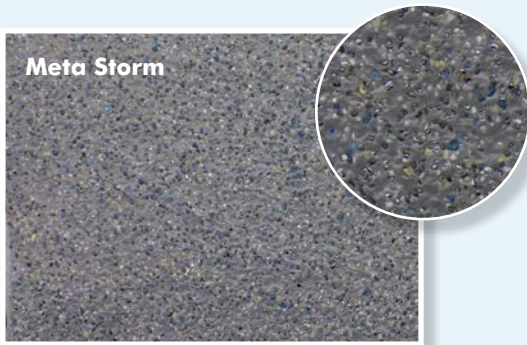

Smartfloor floor covering is especially designed for intensive use in the transport sector. The anti-skid surface makes this wear-resistant floor covering a perfect and durable solution for use in vehicles and for the conveyance of passengers.

- Safe anti-skid principle, even in wet conditions
- Durable and hard-wearing
- Colour fast throughout the active service life
- Flexible to install near wheel housing and boarding structures
- Dirt-resistant and easy to clean
- Saves fuel thanks to low weight

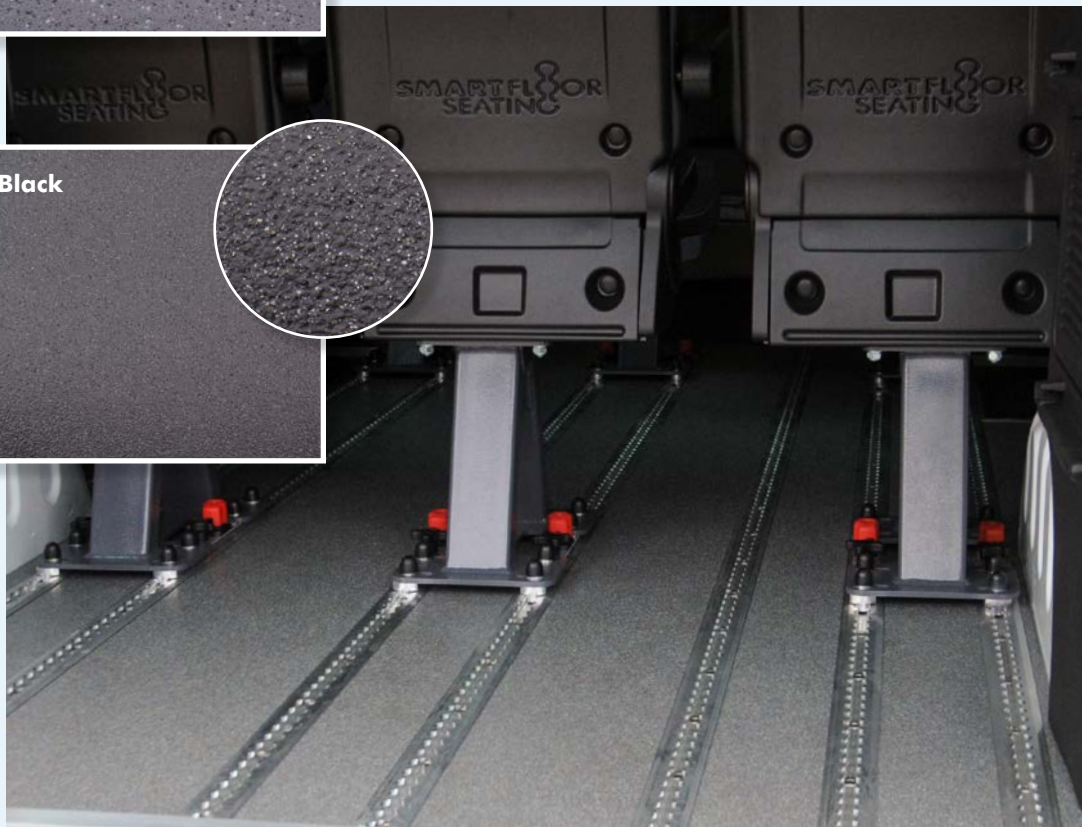
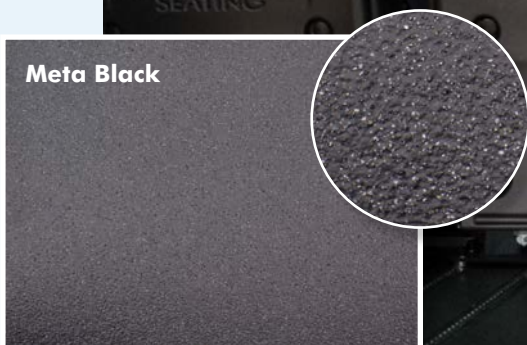
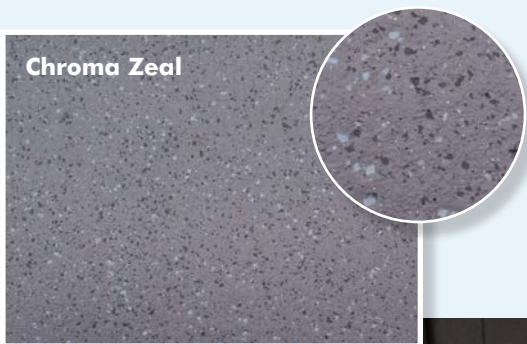

Composition	
Matrix	High-quality vinyl
Ingredients	Aluminium oxide pellets, silicium carbide in the wearing course, quartz basic colour in the surface layer with additional coloured chips for the Altro Transflor Chroma series
Structure support	Polyester cellulose reinforced with glass fibre
Backing	Polyester cellulose
Optional backing	Backing with polyester-like structure (see Altro supplier)

Recommended cleaning method

Thanks to the technical development of Altro safety floors, the floors are considerably easier to clean. Visit www.altrotransflor.com for extensive cleaning advice from Altro Transflor.

Installation and maintenance

All fitting must be carried out in accordance with the local standards and the Altro Transflor installation manual.

Sub-floor and adhesives In accordance with the recommendations in the Altro Transflor installation manual (see also www.altrotransflor.com)

Note: failure to comply with the Altro Transflor installation instructions can lead to reduced performance and slip resistance of the floor. The floor must be thoroughly cleaned before delivery and protected during other work.

Altro Transflor Meta and Chroma are not suited for spaces in which it is allowed to smoke, as the risk of burning cigarettes compromising the floor is too high.

Choice of colour

When choosing the colour of the Altro Transflor floor, the volume of traffic in the room must be taken into account. When in doubt, please contact Smartfloor.

Item code	Item name	Measurement
10003965	Altro Transflor Chroma Zeal	20 x 2 Mtr
10003962	Altro Transflor Meta Black	20 x 2 Mtr
10008057	Altro Transflor Meta Storm	20 x 2 Mtr







These facts make all the difference

- High-precision manoeuvring in various height levels, e.g. for hospital beds, x-ray tables, CT etc.
- The quick-release-fixing allows for an easy fitting to the vehicle's floor
- Big wheels ensure smooth operation on uneven grounds
- The AMF-Bruns stretcher is fully hydraulically adjustable
- The AMF-Bruns stretcher allows for an ergonomic operation.
- The stretcher's suspension guarantees gentle transportation
- The AMF-Bruns stretcher is 10G TÜV tested in all directions according to DIN EN 1789
- In connection with Smartfloor the stretcher can be fixed in various ways to the vehicle - the ideal, flexible solution for the combination of wheelchair and horizontal transportation



Side Steps
Electric Side Step

The electric step is mounted under the vehicle at the side door. It is either operated after opening the side door via a rocker switch on the B-pillar, an acoustic warning tone signals that the electric step has been extended. It is operated via a switch in the B-pillar of the sliding door. The switch cannot be reached while driving. Optional: The electric step can also operate automatically when the door is opened.

SPECIFICATION

- Aluminium step; perforated sheet, anodised surface slip resistance R11)
- Complies with DIN 75078 and covers at least 70 % of the vehicle entrance area
- High-quality processing, absolutely weatherproof
- Load capacity 150 kg
- Audible alarm with extended side step
- Optional: Fully automatic step – deploys automatically when opening side door and stows when closing door respectively



Model	Item Code	Vehicle	Wheelbase			Drive		Step depth	Step width	Total width	Weight
			LWB	MWB	SWB	Back	Front				
FS	200478763	Ford Transit F7	x	x		x	x	290 mm	1060 mm	1150 mm	26 kg
F3	200478774	Ford Transit Custom	x		x		x	290 mm	810 mm	900 mm	23 kg
FS	200487769	Mercedes-Benz Sprinter	x	x		x	x	290 mm	1060 mm	1150 mm	26 kg
F3	200487881	Mercedes-Benz Sprinter			x	x	x	290 mm	810 mm	900 mm	23 kg
FS	200487769	Volkswagen Crafter	x	x		x		290 mm	1060 mm	1150 mm	26 kg
F3	200487881	Volkswagen Crafter			x	x		290 mm	810 mm	900 mm	23 kg
T5	200478908	Volkswagen T5 / T6	x		x		x	290 mm	810 mm	900 mm	22 kg
F3	200487769	Renault Master	x	x			x	290 mm	810 mm	900 mm	23 kg
	200478774	Renault Master			x		x	290 mm	810 mm	900 mm	23 kg
VT	200478925	Renault Trafic	x		x		x	290 mm	810 mm	900 mm	20 kg
		Opel Vivaro	x		x		x	290 mm	810 mm	900 mm	20 kg
FS	200487769	Opel Movano	x	x			x	290 mm	810 mm	900 mm	23 kg
F3	200478774	Opel Movano			x		x	290 mm	810 mm	900 mm	23 kg
B	200478786	Peugeot Boxer	x	x			x	290 mm	810 mm	900 mm	22 kg
		Citroën Jumper	x	x			x	290 mm	810 mm	900 mm	22 kg
		Fiat Ducato	x	x			x	290 mm	810 mm	900 mm	22 kg
U	200478959	Universal	Fitting kit not included					290 mm	810 mm	900 mm	21 kg
M2	200478983	MB Sprinter/VW Crafter (Front passenger door).	x	x	x	x		290 mm	435 mm	525 mm	14 kg

More steps on request.

Option

H20065	Automatic operation for electric step
--------	---------------------------------------

Side Steps
High folding side step for sliding doors

Closes the entire entry step when folded up thus creating additional floor space for a wheelchair.

- Easy and fast handling
- Non-slip ribbed surface
- Absolutely noise-free while driving
- Load capacity 150 kg
- Manual handed operation
- Complies with DIN 75078 and covers at least 70% of the vehicle entrance area

Item Code	Vehicle	Wheelbase			Drive		Side step depth	Side step width	Total width	Weight
		LWB	MWB	SWB	Back	Front				
H20080	Mercedes Benz Sprinter	x	x		x		180 mm	1190 mm	1310 mm	18 kg
H20080	Volkswagen Crafter (until 2016)	x	x		x		180 mm	1190 mm	1310 mm	18 kg
H20081	Mercedes Benz Sprinter			x	x		180 mm	770 mm	890 mm	15 kg
H20081	Volkswagen Crafter (until 2016)			x	x		180 mm	770 mm	890 mm	15 kg
H20085	Volkswagen T5/T6, only Transporter	x		x		x	140 mm	820 mm	940 mm	8 kg

11



The fixed step is mounted on the side door under the vehicle. The hot-dip galvanized steel construction makes it particularly robust and weather-resistant. Step with general Vehicle Type approval (ABE). Installation does not require any further examination by the TÜV.

SPECIFICATION

- Robust steel construction (slip resistance R15)
- Load capacity 150 kg
- Complies with DIN 75078 and covers at least 70 % of the vehicle entrance area
- Comfortable access
- No electrical connection required

Model	Item code	Vehicle type	Wheelbase			Drive		Step depth	Step width	Total width	Weight
			LWB	MWB	SWB	RWD	FWD				
L/F	200922933	Ford Transit F7	x	x			x	190 mm	1445 mm	1475 mm	20 kg
L/G	200923222	Ford Transit F7	x	x		x		190 mm	1445 mm	1475 mm	20 kg
K/H	200581833	Ford Transit Custom	x		x		x	190 mm	1150 mm	1180 mm	13 kg
K/B	200923219	Volkswagen T5 / T6	x		x		x	190 mm	1150 mm	1180 mm	15 kg
L/J	200923597	Mercedes-Benz Sprinter (VS03)	x	x		x		190 mm	1445 mm	1475 mm	21 kg
K/J	200923598	Mercedes-Benz Sprinter (VS30)			x	x		190 mm	1150 mm	1180 mm	20 kg
L/I	200510676	Volkswagen Crafter / MAN TGE	x	x		x		190 mm	1445 mm	1475 mm	20 kg
L/C	200167109	Mercedes-Benz Sprinter / Volkswagen Crafter (until 2016)	x	x		x		190 mm	1445 mm	1475 mm	21 kg
K/C	200167159	Mercedes-Benz Sprinter / Volkswagen Crafter (until 2016)			x	x		190 mm	1150 mm	1180 mm	19 kg
K/D	200923183	Peugeot Boxer	x	x			x	190 mm	1445 mm	1475 mm	15 kg
K/D	200923183	Citroën Jumper	x	x			x	190 mm	1445 mm	1475 mm	15 kg
K/D	200923183	Fiat Ducato	x	x			x	190 mm	1445 mm	1475 mm	15 kg



Ramps
Euroramp

Ramps

- Aluminium
- Centre-folding
- Fitted with quick locking system
- Robust: 20G collision-tested
- Weight ranging from 35 kg to 46 kg, depending on type
- Easy operation with two handles and pneumatic absorber
- Extreme no slippery surface (R11)
- Single hand operation
- Options: * 90° opening
* extra support 200 KG capacity increase



Item number	description	dimension	load
H20115	Euro Ramp	2.00 m x 0.80 m	300 kg
H20101	Euro Ramp	2.40 m x 0.60 m	300 kg
H20104	Euro Ramp	2.40 m x 0.70 m	300 kg
H20110	Euro Ramp	2.40 m x 0.80 m	300 kg
H20107	Euro Ramp	2.40 m x 0.90 m	300 kg
H20133	Euro Ramp	2.40 m x 1.20 m	300 kg
H20114	Euro Ramp	2.80 m x 0.90 m	300 kg
H20116	Euro ramp	2.80 m x 1.20 m	300 kg
On request	Euro Ramp with 90° opening facility		
On request	Euro Ramp with extra support (200 kg capacity increase, 500 kg total load)		



90° opening facility

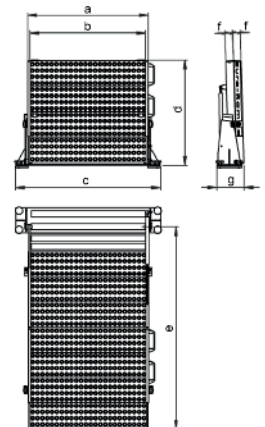

Measurement (mm)	Description	Measurement (mm)						
		A	B	C	D	E	F	G
2.400 x 600	standard	640	600	830	1.230	2.390	60	215
	swivelling			970	1.245			
2.400 x 700	standard	740	700	930	1.230	2.390	60	215
	swivelling			1.070	2.045			
2.400 x 900	standard	950	910	1.140	1.230	2.390	80	230
	swivelling			1.280	1.245			
2.400 x 800	standard	840	800	1.030	1.230	2.390	60	215
	swivelling			1.170	1.245			
2.800 x 900	standard	950	910	1.140	1.430	2.780	100	245
	swivelling			1.280	1.440			
2.000 x 800	standard	840	800	1.030	1.030	1.990	60	215
	swivelling			1.170	1.045			

Linear lifts

AMF-BRUNS - AL1 Solid Lift

Fully automatic lift for rear or side door. The AL1 uses aluminium profiles for the unique design of its purpose-built lifting arms. The newly designed aluminum arms make the AL1 the lightest patented lift on the market. The transparent design of the linear platform lift provides excellent rearward visibility.

These points count:

- Patented, newly developed aluminum arms make the AL1 the lightest lift on the market.
- Unique design
- Can be used for rear and side entry
- LED warning lights, optional LED ramp lighting
- Ramp design ensures excellent rear visibility.
- Special safety brake works automatically after contact with the ground, even on uneven terrain
- Access grid serves as an automatic safety brake (patented)
- Crash safety stops for greater passive safety
- High-quality powder-coated finish, with CDP coating as additional corrosion protection
- EMC-tested in accordance with EU directives
- Meets EN 1756, II and DIN 75078, 1
- 20G collision tested

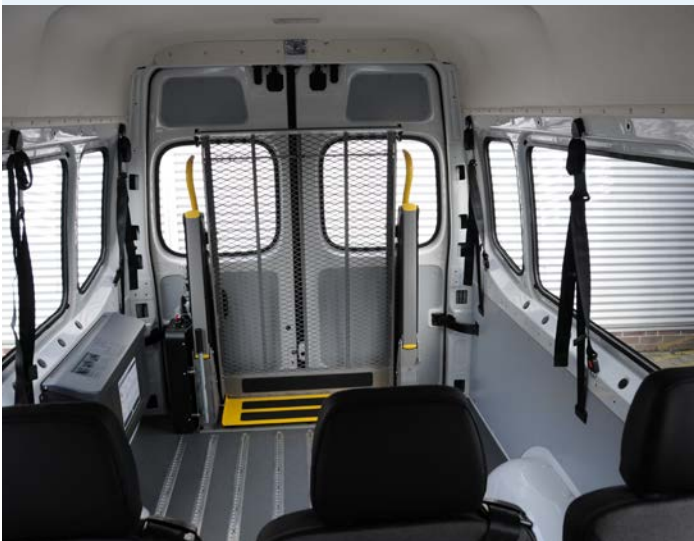

Technical data

- 900 mm lift height
- Load capacity 400 kg
- Weight Depends on ramp size between 120 kg and 130 kg
- Operation single-handed with 4 push buttons (up/down, park/operate)
- Manual pump, two rails, automatic warning lights
- Power, 12 V electro hydraulic motor

Optional

- Bluetooth remote control or App operation (IOS, Android).
- Remote control available
- 20G tested mounting kits for vehicle models like Mercedes-Benz Sprinter, Volkswagen Crafter, Volkswagen T6, Renault Master, Opel Movano, Ford Transit

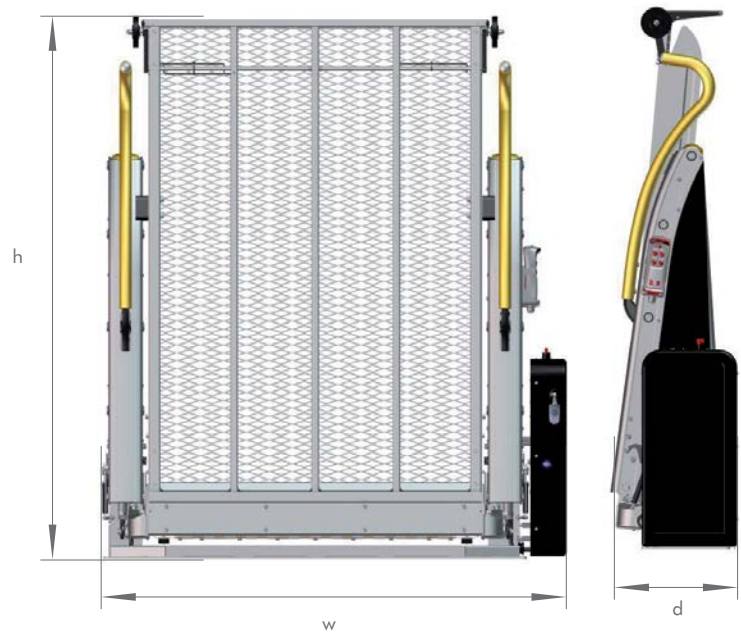

Item code	10018371	10018372	10018373
TYPE	AL1 1380	AL1 1130	AL1 1065
Width (w)	1,290 mm	1,200 mm	1,120 mm
Depth (d)	350 mm	350 mm	350 mm
Height (h)	1,500 mm	1,250 mm	1,185 mm

Useful ramp sizes			
Width	920 mm	830 mm	750 mm
Length	1,380 mm	1,130 mm	1,065 mm

		Jumper Boxer Ducato	Sprinter Crafter	T5/T6 only Transporter	Ford Transit	Ford Transit MY2015	Ford Transit Custom	B Vito V-Klasse	Master Movano NV400	Trafic Vivaro NV300 Talento
Item Code										
AL 1 1380	10018371	x 1)	x 2)		x 2)	x 2)	x 1)		x 1) 2)	
AL 1 1130	10018372	x	x	x 2)	x	x	x 2)		x	x 2)
AL 1 1065	10018373	x	x	x	x	x	x		x	x

1) Not suitable for vehicle height H1

2) Mountingkit available

No liability whatsoever can be accepted for variations due to technical changes or vehicle-specific equipment. Please feel free to contact Smartfloor if you are in any doubt.

Linear lifts

AMF-BRUNS - AL1 Split Platform Lift

Fully automatic lift for rear or side door. The AL1 uses aluminium profiles for the unique design of its purpose-built lifting arms. The newly designed aluminum arms make the AL1 the lightest patented lift on the market. The split ramp ensures a clear view to the rear yet allows entry and exit through the rear door.

Benefits

- Patented, newly developed aluminum arms make the AL1 the lightest lift on the market.
- Can be used for rear and side entry
- LED warning lights, optional LED ramp lighting
- Three standard ramp sizes available
- Ramp design ensures excellent rear visibility.
- Special safety brake works automatically after contact with the ground, even on uneven terrain
- Access grid serves as an automatic safety brake (patented)
- Quiet ride with rubber-mounted ramp in stowed position
- Crash safety stops for greater passive safety
- EMC-tested in accordance with EU directives
- Meets EN 1756, II and DIN 75078, 1
- 20G collision tested



Technical data

- Load capacity 400 kg
- 900 mm lift height
- High-quality powder-coated finish, with CDP coating as additional corrosion protection
- Single-handed with 4 push buttons (up down, park/ operate)
- Weight depends on ramp size; between 122 kg and 140 kg
- Manual pump, two rails, automatic warning lights

Option

- Bluetooth remote control or App operation (IOS, Android).
- Remote control available
- 20G tested mounting kits for most vehicle models.

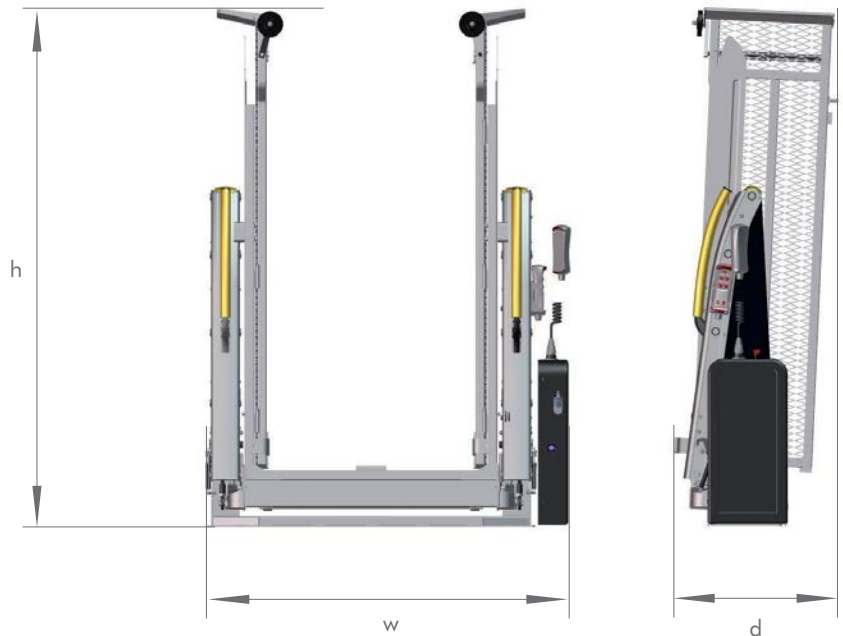

Item code		10018378	10018379	10018380
TYPE		Split 1300	Split 1085	Split 1085S
Width	(w)	1,200 mm	1,120 mm	1,040 mm
Depth	(d)	500 mm	500 mm	500 mm
Height	(h)	1,405 mm	1,190 mm	1,190 mm
Useful ramp sizes				
Width		830 mm	750 mm	670 mm
Length		1,300 mm	1,085 mm	1,085 mm

Item Code		Jumper Boxer Ducato	Sprinter Crafter	Ford Transit	Ford Transit MY2015	Ford Transit Custom	Master Movano NV400	Traffic Vivaro NV300 Talento
Split 1300	10018378	x 1)	x 1)	x 1)	x 1)		x 1)	
Split 1085	10018379	x	x	x	x	x	x	x
Split 1085S	10018380	x	x	x	x	x	x	x

1) Not suitable for vehicle height H1

No liability whatsoever can be accepted for variations due to technical changes or vehicle-specific equipment. Please feel free to contact Smartfloor if you are in any doubt.

Linear lifts

AMF-BRUNS - AL1 Panorama Lift

Fully automatic lift for rear or side door. The AL1 uses aluminium profiles for the unique design of its purpose-built lifting arms. The newly designed aluminum arms make the AL1 the lightest patented lift on the market. The panorama platform allows the installation of a large lift in vehicles with low interior height.

Benefits

- Patented, newly developed aluminum arms make the AL1 the lightest lift on the market.
- Unique Design
- Can be used for rear and side entry
- LED warning lights, optional LED ramp lighting
- Two standard ramp sizes available
- Ramp design ensures excellent rear visibility.
- Suitable for vehicles with a low roof
- Special safety brake works automatically after contact with the ground, even on uneven terrain
- Access grid serves as an automatic safety brake (patented)
- 900 mm lift height
- Crash safety stops for greater passive safety
- High-quality powder-coated finish, with CDP coating as additional corrosion protection
- EMC-tested in accordance with EU directives
- Meets EN 1756, II and DIN 75078, 1
- 20G collision tested



Technical data

Load capacity 400 kg
Single-handed operation with 4 push buttons (up/down, park/operate)
Weight depending on platform size; between 135 kg and 140 kg Manual pump, two rails, automatic warning lights

Option

- Bluetooth remote control or App operation (IOS, Android).
- Remote control available
- 20G tested mounting kits for vehicle models like Mercedes-Benz Sprinter, Volkswagen Crafter, Volkswagen T6, Renault Master, Opel Movano, Ford Transit

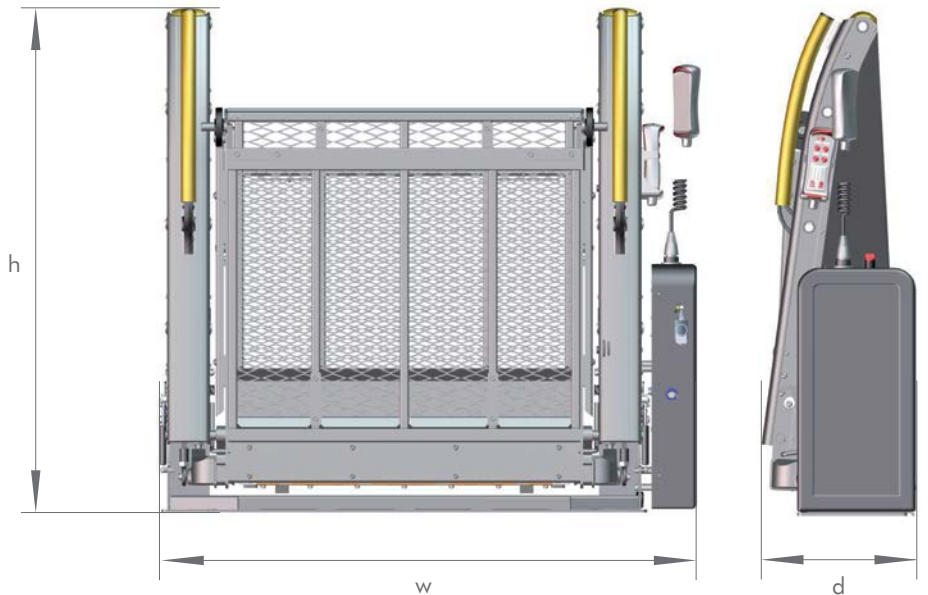

Item code

10018375

10018374

TYPE

AL1 1200

AL1 1400

Width (w)	1,200 mm	1,200 mm
Depth (d)	350 mm	350 mm
Height (h)	1,125 mm	1,125 mm

Useful ramp sizes

Width	755 mm	755 mm
Length	1,200 mm	1,400 mm

Item Code		Jumper Boxer Ducato	Sprinter Crafter	T5/T6 only Transporter	Ford Transit	Ford Transit MY2015	Ford Transit Custom	B Vito V-Klasse	Master Movano NV400	Trafic Vivaro NV300 Talento
AL1 1400	10018374	x	x	x 2)	x	x	x	x	x	x
AL1 1200	10018375	x	x	x 2)	x	x	x	x	x	x

2) Mountingkit available

No liability whatsoever can be accepted for variations due to technical changes or vehicle-specific equipment. Please feel free to contact Smartfloor if you are in any doubt.

Lifts
Overview mounting kits for linear lift AL1

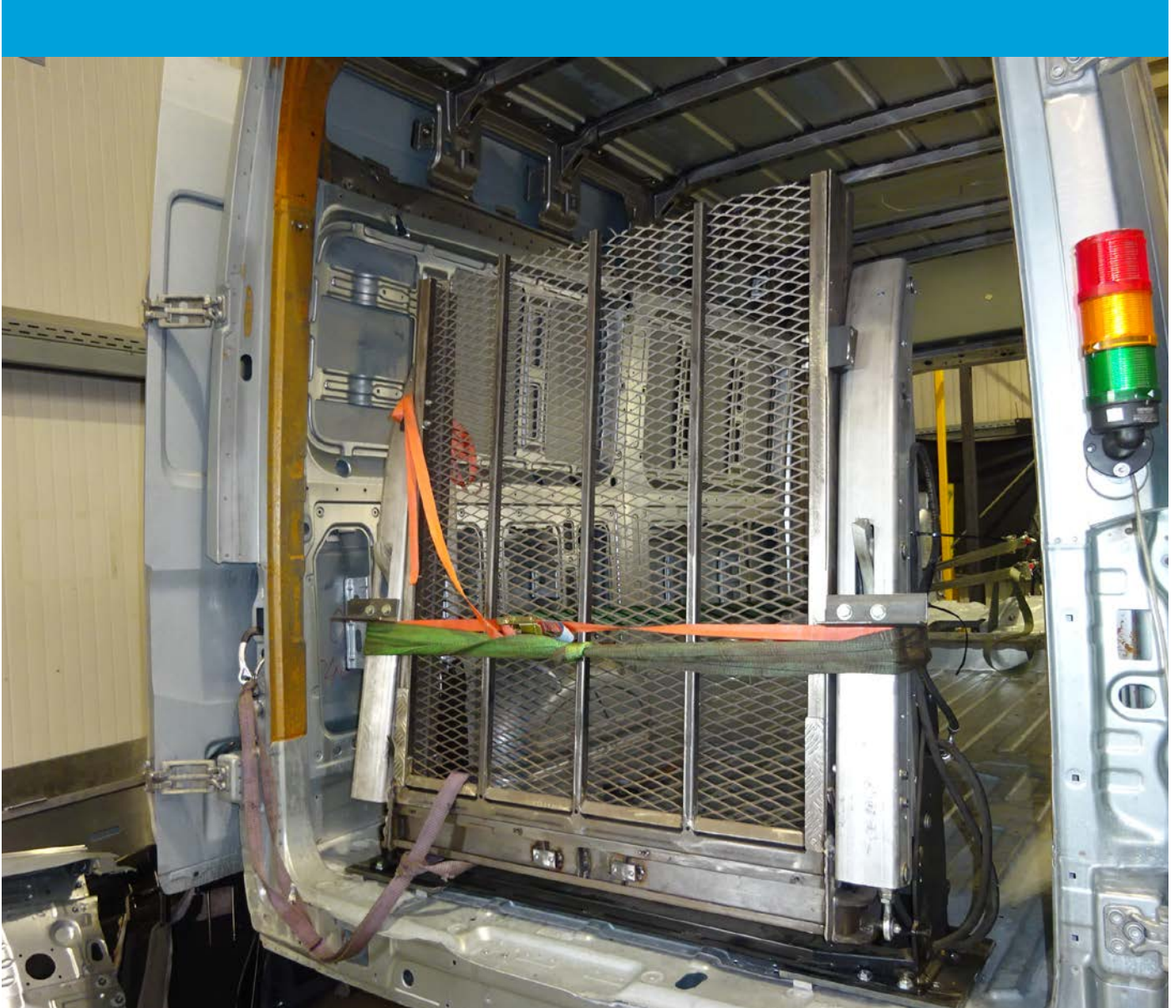

Overview mounting kits for linear lift AL1

Smartfloor offers AL1 mounting kits for the following vehicle types:



Item Code	Vehicle type	Vehicle Floor	Direction of travel	AL1 Lift	Instruction GER	Instruction EN
H1402	Opel Movano / Renault Master	Original floor / Smartfloor	right	AL1 Solid 1380	10018293	10018489
H1400	Mercedes-Benz Sprinter / VW Crafter (old)	Original floor / Smartfloor	right	AL1 Solid 1380	10018292	10018488
H1404	Ford Transit	Original floor / Smartfloor	right	AL1 Solid 1380	10018291	10018487
H1406	Ford Transit F7	Original floor / Smartfloor	right	AL1 Solid 1380	10019784	10022312
H1407	Ford Transit Custom	Original floor / Smartfloor	right	AL1 Solid 1130 Panorama 1200/1400	10022409	10022410
H1407	Ford Transit Custom (without air condition)	Original floor / Smartfloor	right	AL1 Solid 1380	10022409	10022410
H1408	Opel Vivaro / Renault Trafic / Fiat Talento / Nissan NV300	Original floor / Smartfloor	right	AL1 Solid 1130/1200 Panorama 1200/1400	10022431	10022934
H1409	Mercedes-Benz Vito / V-Class	Original floor	right	Panorama 1200/1400	10022407	10022408
200460048	VW Crafter / MAN TGE (new)	Smartfloor	right	AL1 Solid 1380	10022932	10022933
H1405	VW T5 / T6	Smartfloor	right	Panorama 1200/1400	10018294	10018490
H1410	VW T5 / T6 Multivan	Original floor	right	Panorama 1200/1400		
–	Fiat Ducato		right			

Optional

AMF-Bruns has developed a standardised operation for all cassette and linear lifts. Standard operation of the newly developed control unit (for cassette and linear lift) is a hand control with cable connection to the lift. Additionally a remote control unit is available as a wireless version, with handset operation or new smartphone app (iOS, Android).



Mobile operation via App

- Intuitive operation
- Mobile remote control covers all functions and tools from the original remote control
- Available for Smartphones (iOS and Android)

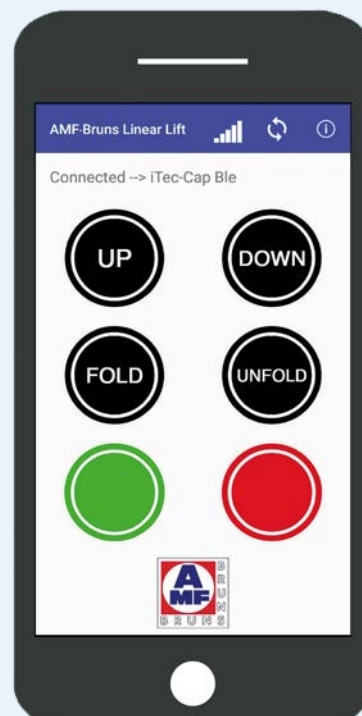

The ultra-slim AMF-Bruns cassette lift for the side loading door

The cassette lift K70 is the flattest back-in-the-box lift of its kind for the side door. The lift is installed underneath the vehicle floor in order to make the best possible use of the available space within the vehicle. The large lifting platform is suitable for large electric wheelchairs. The cassette lift K70 is only suitable for vans such as Volkswagen T6 or Renault Trafic L2.

Specification

- Load capacity 300 kg, complies with EN 1756, II
- Ultra-slim design (70 mm) guarantees ultimate ground clearance
- New illuminated controls, waterproof and shockproof (!)
- Automatic barrier operates on uneven roads and snow, too!
- Original step is obtained
- Vehicle interior remains unchanged
- Powerful, quiet action ensures smooth operation of the lifting platform
- Totally enclosed stainless steel box provides protection for the lift system even in extreme weather conditions
- Manual emergency operation
- No changes to the car body necessary
- EMC tested according to EU-regulation 95/54/EG/EC
- Original tank is replaced by an AMF-bruns tank (only Diesel engine)
- Obtaining original tank at bad road suspension

TECHNICAL DATA

» Hight	70 mm	» Deploying/ stowing	Approx. 12 sec.
» Load capacity	300 kg	» Control	By push buttons
» Platform size	Approx. 760 x 1.200 mm	» Power	Lifting and lowering electro-hydraulic 12 V; deploying and stowing driven by 12 V electric motor
» Unladen weight	Approx. 170 kg		
» Lifting/Lowering	Approx. 7 sec.		

Optional

Bluetooth remote control or app operation (iOs, Android)



Cassette lifts
AMF-Bruns Cassette lift

K 90

A cassette lift is installed underneath the vehicle floor in order to make the best possible use of the available space within the vehicle. A cassette lift can be installed at the side of the vehicle. The AMF-Bruns cassette lifts are only suitable for installation in passenger transport vans such as VW T6 and larger. We provide special rear-squat solutions for passenger vehicles.

- Load-bearing capacity of up to 300 kg
- Platform is also suitable for electric wheelchairs
- Easy electro-hydraulic dual-button operation
- Ultra-slim design to save floor space within the vehicle
- No alterations in the vehicle needed
- Fitted with manual emergency operation
- Platform weight 140 kg

K90 Active

1 METER OF FREE SPACE IS ENOUGH

The AMF-Bruns K90 Active lift is a new high-quality cassette lift for active and independent wheelchair users.

Extremely suitable for narrow parking spaces

Narrow parking spaces are no longer an obstacle, thanks to a platform width of less than 70 cm on the ground. For maximum ease of use, the lift platform can be accessed from both sides, parallel to the linear direction of the vehicle. Ideal in parking spaces with cars parked on both sides of the vehicle, or in a busy street with cars parked both in front and behind the vehicle.

Ultra-slim

As so little space is needed, the K90 Active is easy to install. The lift is fitted underneath the vehicle's sliding door at the right side of the vehicle. Thanks to its ultra-slim design, you only need a maximum of 90 mm underneath the vehicle to install it. The vehicle's interior remains fully intact. This lightweight lift guarantees quick, simple and convenient use.



- Lift platform accessible from two sides
- Load-bearing capacity of up to 200 kg
- Fast and simple to operate
- Ultra-slim design to save floor space within the vehicle
- No need for vehicle alterations to the bottom

The K90 Active can only be installed in passenger vans such as Volkswagen T6 and larger.

K 90



K 90 Active

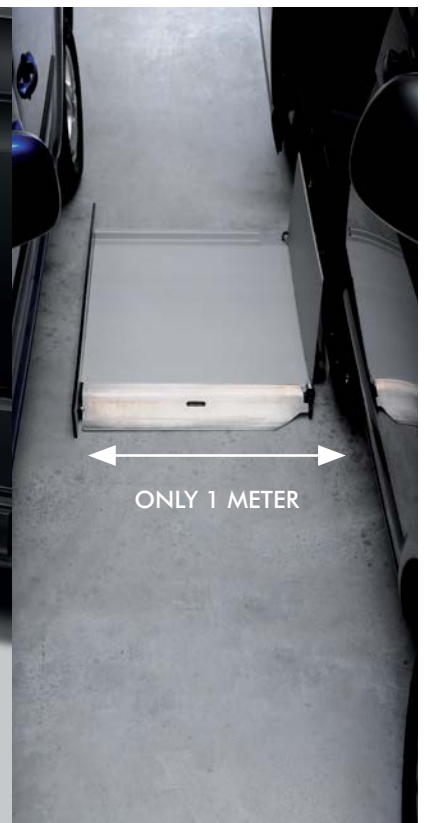

Cassette Lifts
AMF-Bruns Cassette Lifts

Item Code	Description	Dimensions (w x h)
10023012	K70	760 x 1.200 mm
10023013	K70 with lateral access	760 x 1.200 mm
H 9000	K90	800 x 1.200 mm

Underfloor Cassette Lifts - Vehicle Matrix

Vehicle model	K70 side mounted	K90 side mounted
Jumper / Relay / Boxer / Ducato (not SWB)	No	Yes
Ford Transit (only FWD)	No	Yes
Vito / V-Class (not petrol derivatives)	Yes	Yes
Sprinter / Crafter	No	Yes
Master / Movano / NV 400 (not SWB)	No	Yes
Volkswagen T5 (not V6 petrol or 4Motion derivatives)	Yes	Yes
Volkswagen T6 (not petrol derivatives)	Yes	Yes (2)

Yes (1) = only right side of vehicle

Yes (2) = also with 4Motion

Cassette lift K90 Active on request.

Telescopic ramps for side and rear doors

When required the ramps are positioned one after the other on the edge of the vehicle door. Roll the wheelchair over the ramps into the vehicle. This can be an empty wheelchair as well as one carrying an occupant. When not needed, the telescopic aluminium ramps can be conveniently stored in the vehicle. It should be noted that the ramps are extremely light and can be carried in much the same way, for example, as a carrier bag by the handles on the side.

- Load capacity: up to 2 x 150 kg
- Total length: 2 m (collapsed 1.2 m)
- Weight: approx. 12 kg
- Easy to handle, easy to operate
- Stable construction
- Extremely lightweight due to special aluminium profiles
- Foldable to manageable dimensions
- Easy carrying with the provision of a grab handle
- Applicable for all estate vehicles
- Suitable for all combi-vehicles
- Can be mounted on the rear or side doors
- Slip resistance class R11

Item code	Item name	Length
10022633	channel ramp	2 m

AMF-Bruns Telescopic Ramp



Lowering suspension systems
Rear lowering suspension for accessible vehicles



Technical data

- Raising / lowering mechanism Powerful, low noise 12V hydraulic power unit
- Drive Electro-hydraulic from the vehicle battery
- Lowering control Rocker switch in the rear of the vehicle
- Raising control Automatically when rear door is being closed

Optional

Ramps in different sizes (see ramps)



Vehicle ready for departure (standard height).



Lowered vehicle.

Item code	Vehicle model	Including
10022600	Volkswagen Crafter (old) MWB / Mercedes-Benz Sprinter MWB	Hydraulic kit for lowering suspension – without ramp
10022601	Volkswagen Crafter (old) LWB / Mercedes-Benz Sprinter LWB	Hydraulic kit for lowering suspension – without ramp
10023226	Fiat Ducato / Citroën Jumper / Peugeot Boxer / Dodge RamMaster	Hydraulic kit for lowering suspension – without ramp
10023007	Volkswagen Crafter / MAN TGE	Hydraulic kit for lowering suspension – without ramp
10023266	Volkswagen T5 / T6	Hydraulic kit for lowering suspension – without ramp
10023273	Ford Transit (F7) MWB	Hydraulic kit for lowering suspension – without ramp
10023279	Ford Transit (F7) LWB	Hydraulic kit for lowering suspension – without ramp
10022613	Renault Master / Opel Movano / Nissan NV400	Hydraulic kit for lowering suspension – without ramp



Rear Cut Floor Conversion Kits
Volkswagen Caddy / Volkswagen Caddy Maxi



Seating arrangements (may vary depending on wheelchair)

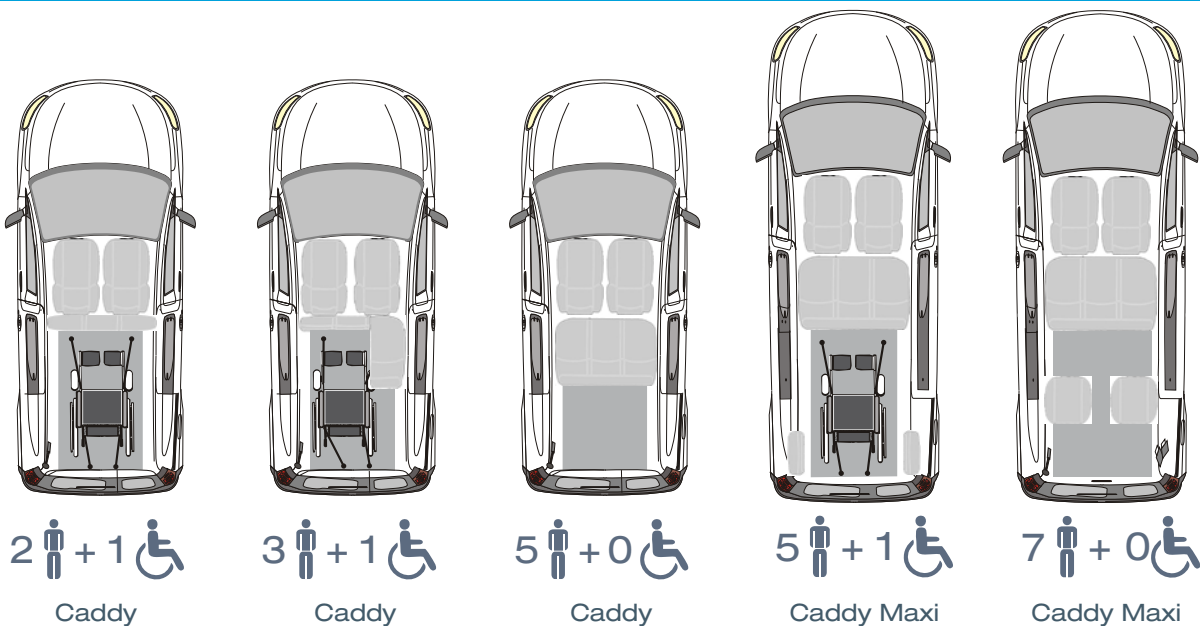

Technical Data

Wheelchair area height dimensions rear entrance height with tailgate approx. 1.410 mm
interior height approx. 1.460 mm (rear area)

Wheelchair area floor dimensions width approx. 810 mm x length approx. 1.380 mm (SWB)
width approx. 810 mm x length approx. 1.500 mm (LWB)

Optional

- **EASYFLEX** Ramp
- **FUTURESAFE**
- More options on request

Conversion kit: Information on request
Original tank & AdBlue tank remain.



Seating arrangements (may vary depending on wheelchair)



2 + 1

Dokker



3 + 1

Dokker



5 + 0

Dokker

Technical Data

Wheelchair area height dimensions rear entrance height approx. 1.400 mm
interior height approx. 1.450 mm

Wheelchair area floor dimensions width approx. 810 mm
length approx. 1.510 mm

Optional

- **EASYFLEX** Ramp
- **FUTURESAFE**
- More options on request

Conversion kit: Information on request
Original tank remains.

Rear Cut Floor Conversion Kits
Ford Transit Connect SWB / LWB



Seating arrangements (may vary depending on wheelchair)

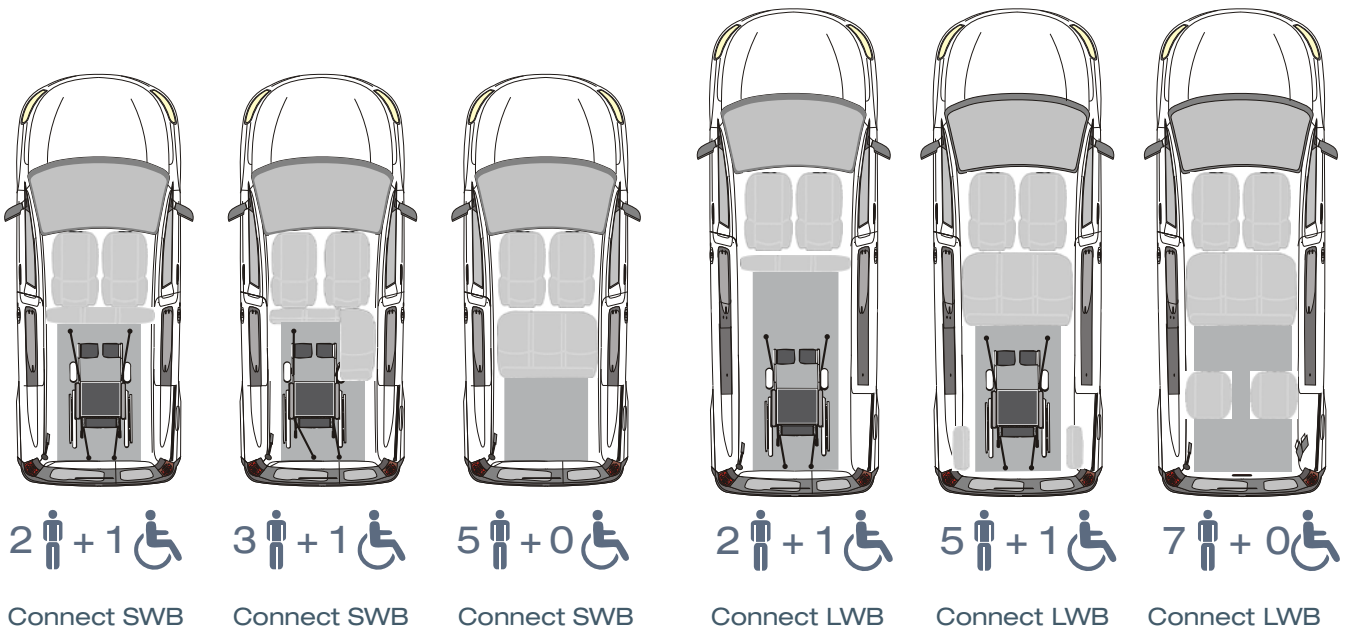

Technical Data

Wheelchair area height dimensions rear entrance height with twin door approx.. 1.420 mm
interior height approx. 1.450 mm (wheelchair area)
rear entrance height with tailgate approx. 1.470 mm
interior height approx. 1.450 mm (wheelchair area)

Wheelchair area floor dimensions width approx. 810 mm x length approx. 1.600 mm (LWB)

Optional

- **EASYFLEX** Ramp
- **FUTURESAFE**
- Rotating seat left / right
- More options on request

Conversion kit: Information on request
Original tank is replaced.



Seating arrangements (may vary depending on wheelchair)

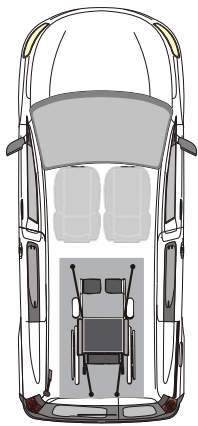

2 + 1

Citan LWB / Kangoo

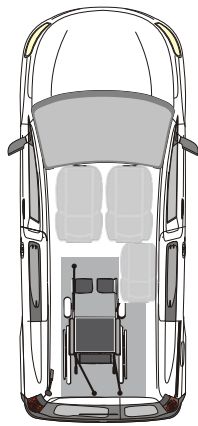

3 + 1

Citan LWB / Kangoo

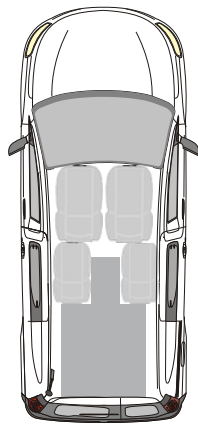

4 + 0

Citan LWB / Kangoo

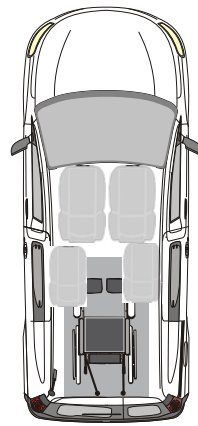

4 + 1

Citan LWB / Kangoo

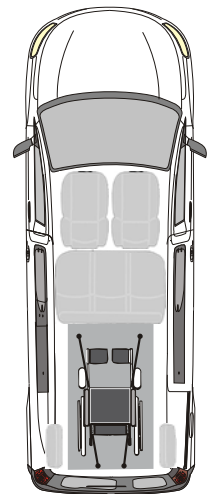

5 + 1

Citan xLWB / Kangoo Maxi

Technical Data

Wheelchair area height dimensions rear entrance height approx. 1.400 mm
interior height approx. 1.450 mm

Wheelchair area floor dimensions width approx. 830 mm x length approx. 1.300 mm

Optional

- **EASYFLEX** Ramp (Citan xLWB / Kangoo Maxi)
- **FUTURESAFE**
- Lowering suspension
- Two single seats (Citan LWB / Kangoo)
- More options on request

Conversion kit: Information on request
Original tank is replaced.

Rear Cut Floor Conversion Kits
Mercedes-Benz Vito MWB / LWB (FWD)



Seating arrangements (may vary depending on wheelchair)

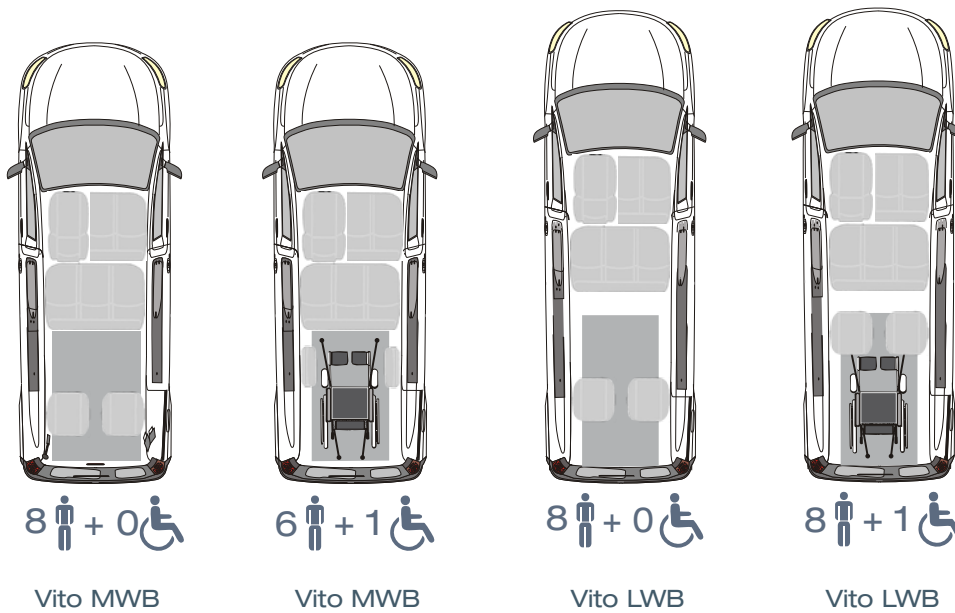

Technical Data

Wheelchair area height dimensions rear entrance height approx. 1.500 mm
interior height approx. 1.450 mm

Wheelchair area floor dimensions width approx. 810 mm x length approx. 1.450 mm

Optional

- **EASYFLEX** Ramp
- **FUTURESAFE**
- Rotating seats
- More options on request

Conversion kit: Information on request
Original tank remains.

Front And Rear Wheel Drive



Seating arrangements (may vary depending on wheelchair)

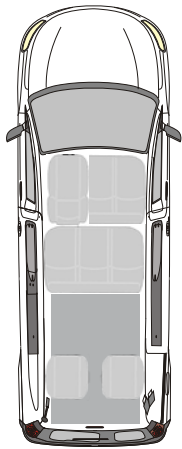

8 + 0

Vito MWB

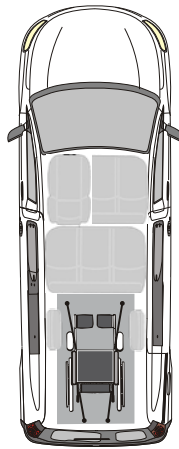

6 + 1

Vito MWB

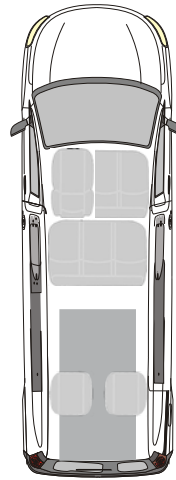

8 + 0

Vito LWB

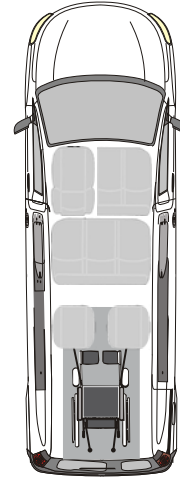

8 + 1

Vito LWB

Technical Data

Wheelchair area height dimensions rear entrance height approx. 1.470 mm
interior height approx. 1.425 mm

Wheelchair area floor dimensions width approx. 810 mm x length approx. 1.300 mm

Optional

- **EASYFLEX** Ramp
- **FUTURESAFE**
- Rotating seats
- More options on request

Conversion kit: Information on request
Original tank remains.

Rear Cut Floor Conversion Kits
Fiat Talento / Nissan NV300 / Renault Trafic SWB / LWB



Seating arrangements (may vary depending on wheelchair)

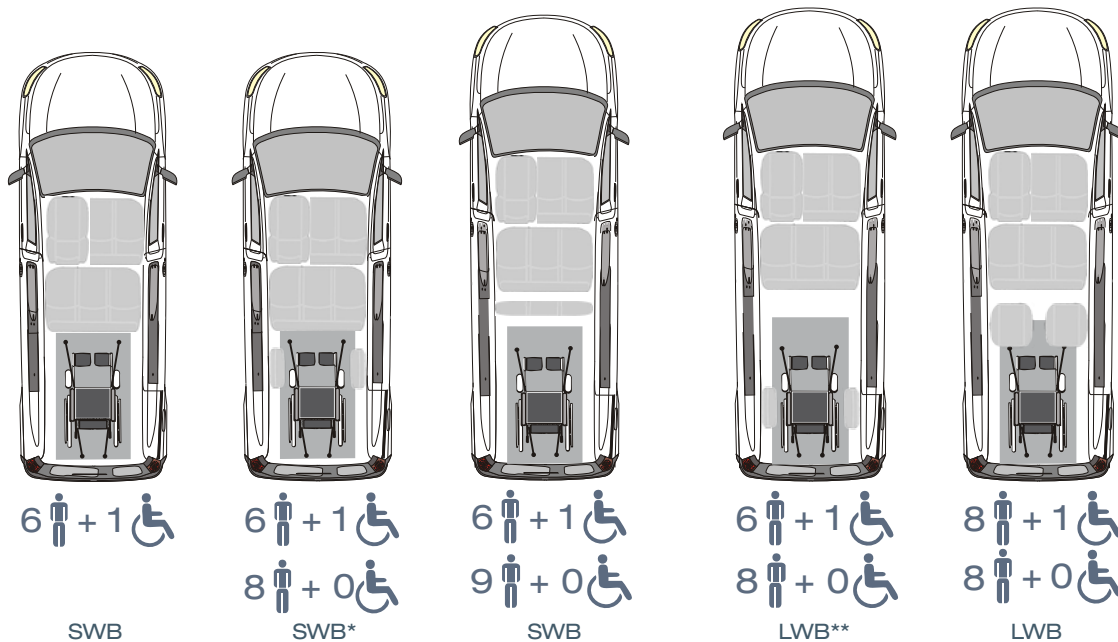

* with tip & fold seats; EasyFlex ramp possible with air condition
** limited space in the passenger compartment

Technical Data

Wheelchair area height dimensions rear entrance height approx. 1.590 mm
interior height approx. 1.500 mm

Wheelchair area floor dimensions width approx. 810 mm x length approx. 1.410 mm

Optional

- **EASYFLEX** Ramp
- **FUTURESAFE**
- Rotating seats
- More options on request

Conversion kit: Information on request
Original tank in L1 and L2 remains. As a result of the mounting and the movement of the tank in L1, inaccuracies in the fuel display may occur.



Seating arrangements (may vary depending on wheelchair)

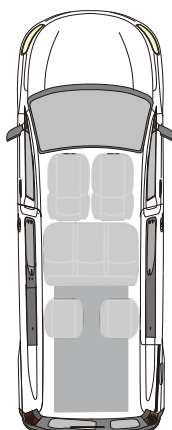

7 + 0

Proace SWB /
SpaceTourer M /
Zafira M /
Traveller MWB

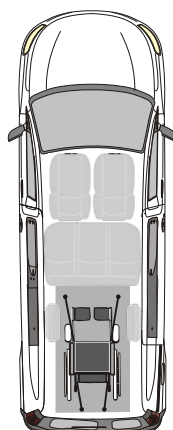

5 + 1

Proace SWB /
SpaceTourer M /
Zafira M /
Traveller MWB

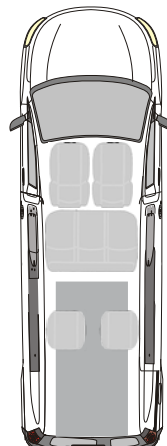

7 + 0

Proace MWB /
SpaceTourer XL/
Zafira L /
Traveller LWB

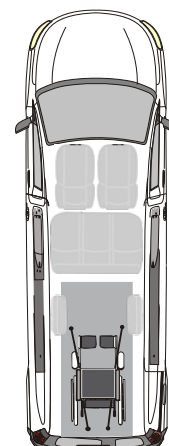

5 + 1

Proace MWB /
SpaceTourer XL/
Zafira L /
Traveller LWB

Technical Data

Wheelchair area height dimensions rear entrance height approx. 1.500 mm
interior height approx. 1.420 mm (rear area)

Wheelchair area floor dimensions width approx. 810 mm x length approx. 1.400 mm (short vehicle version)
width approx. 810 mm x length approx. 1.710 mm (long vehicle version)

Optional

- **EASYFLEX** Ramp
- **FUTURESAFE**
- Two single seats (long vehicle version)
- More options on request

Conversion kit: Information on request
Original tank & Ad Blue tank remains.

Rear Cut Conversion Kits

Citroën Berlingo / Peugeot Rifter / Toyota Proace City SWB / LWB / Opel Combo Life / Combo Life XL



Seating arrangements (may vary depending on wheelchair)

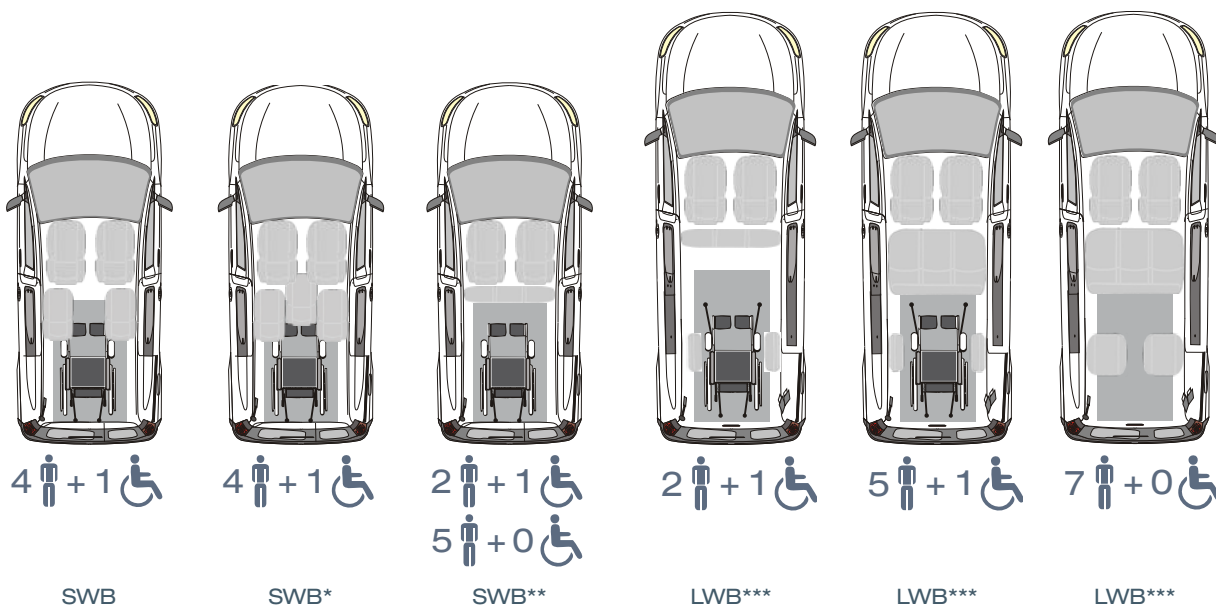

* Three single seats in 2nd row, centre seat sliding (optional) to gain space in the wheelchair area (only for small wheelchairs)
 ** OE bench seat (foldable and slideable)
 *** OE bench seat in 2nd row (foldable and slideable), two optional tip & fold seats in third row

Technical Data

Wheelchair area high dimensions	Rear entrance high approx. 1.450 mm
	Interior high approx. 1.410 mm
Wheelchair area floor dimensions	Width approx. 810 mm x length approx. 1.400 mm

Optional

- **FUTURESAFE**
- Lowering suspension
- More options on request

Conversion kit: Information on request
 Original tank & AdBlue tank remain.

Length	Wheelbase	Conversion	Identical construction			
			Vehicle model	Vehicle model	Vehicle model	Vehicle model
SWB (4.430 mm)	2.681 mm	Yes	Volkswagen Caddy	-	-	-
LWB (4.878 mm)	3.006 mm	Yes	Volkswagen Caddy Maxi	-	-	-
SWB (4.363 mm)	2.810 mm	Yes	Dacia Dokker	-	-	-
SWB (4.418 mm)	2.662 mm	Yes	Ford Transit/Tourneo Connect	-	-	-
LWB (4.818 mm)	3.062 mm	Yes	Ford Transit/Tourneo Connect	-	-	-
SWB (ca. 3.900 mm)	2.313 mm	No	Mercedes-Benz Citan Kompakt	Renault Kangoo Compact	-	-
MWB (ca. 4.300 mm)	2.697 mm	Yes	Mercedes-Benz Citan Long	Renault Kangoo	-	-
LWB (ca. 4.650 mm)	3.081 mm	Yes	Mercedes-Benz Citan Extralong	Renault Kangoo Maxi	-	-
SWB (4.895 mm)	3.200 mm	No	Mercedes-Benz Vito Kompakt	Mercedes-Benz V-Class Kompakt	-	-
MWB (5.140 mm)	3.200 mm	Yes	Mercedes-Benz Vito Long	Mercedes-Benz V-Class Long	-	-
LWB (5.370 mm)	3.430 mm	Yes	Mercedes-Benz Vito Extralong	Mercedes-Benz V-Class Extralong	-	-
SWB ca. 4.999 mm	3.098 mm	Yes	Fiat Talento	Nissan NV300	Renault Trafic Combi	-
LWB ca. 5.399 mm	3.498 mm	Yes	Fiat Talento	Nissan NV300	Renault Trafic Grand Combi	-
SWB (ca. 4.606 mm)	2.925 mm	No	Citroën Spacetourer XS	Opel Zafira Life S	Peugeot Traveller Compact	Toyota Proace Compact
MWB (4.959 mm)	3.275 mm	Yes	Citroën Spacetourer M	Opel Zafira Life M	Peugeot Traveller Standard	Toyota Proace L1
LWB (ca. 5.309 mm)	3.275 mm	Yes	Citroën Spacetourer XL	Opel Zafira Life L	Peugeot Traveller Long	Toyota Proace L2
SWB (4.403 mm)	2.785 mm	Yes	Citroën Berlingo M	Opel Combo Life	Peugeot Rifter Standard	Toyota Proace City
LWB (4.753 mm)	2.975 mm	Yes	Citroën Berlingo XL	Opel Combo Life XL	Peugeot Rifter Long	Toyota Proace City

Various types of fuels could have an impact on the conversion. Please contact Smartfloor for more information.

To be on the safe side

The safety of every wheelchair occupant is our top priority at Smartfloor and is of central importance for all our innovations.

Smartfloor is the leading supplier of system floors and related products for the conversion of accessible vehicles in Europe. This leading position is both a responsibility and a motivation for Smartfloor to ensure that all aspects of its products, which have quality and safety implications, are subject to the strictest of controls. All production work is completed in accordance with the ISO 2001 standard. In addition, all lifts and ramps which the company delivers are TÜV-tested in 20 G front-on vehicle crashes.

All Smartfloor products offer a high level of safety. Vehicle floors equipped with the Smartfloor meet all safety requirements of the stringent EU directives such as UN-ECE R14, R16, R17, ISO 10542 and DIN standard 75078. All surfaces which may present a slip hazard in the vehicle comply with slip resistance class R11. Lifts and electric steps are subjected to thorough EMS tests and then approved by the German Federal Office for Motor Vehicles.

In order to further improve safety and protection for people with mobility restrictions, Smartfloor and its partner AMF-BRUNS have been successfully working in cooperation with competent partners such as TÜV Nord, TÜV Rheinland, BAST, UTAC (France), AIB Vinçotte (Belgium), Status (United Kingdom), Volkswagen, Mercedes Benz, RDW Holland and the German Federal Office for Motor Vehicles.

A major step in the quest for “even more tested safety” has been taken by Smartfloor and AMF-BRUNS with its new in-house accredited test equipment at AMF-BRUNS in Apen, Germany. Together with the Dutch RDW and German TÜV or the British VCA, Smartfloor now tests and examines safety-relevant components, products and retrofitting in house. In future, for example, seat testing, strength testing of built-in vehicle components or wheelchair restraining systems will become routine in our own test centre for all types of vehicles on the market. With up to eight special cylinders the required tension is built up within a matter of milliseconds. In the meantime, other conversion companies are also taking the opportunity to have testing done by Smartfloor.





Images:

1. A vehicle body is fixed to the stable test system frame ready for the tension trials.

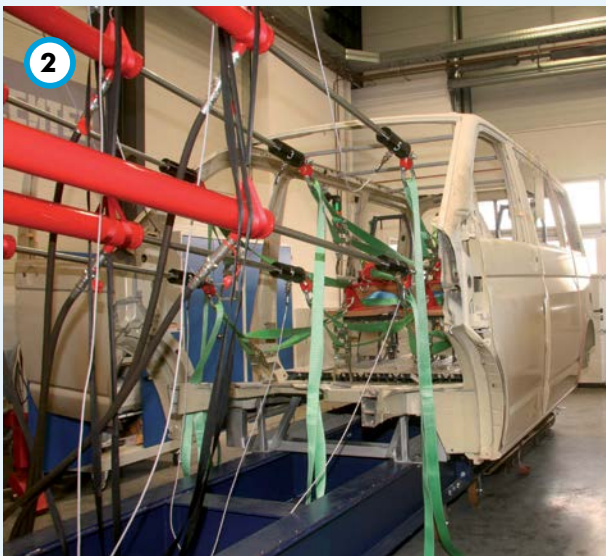

2. Special pulling cylinders ensure that a force equivalent of up to 20 G front-on vehicle crash is built up within milliseconds.



3. This shows a test with 3 M1 seat dummies, aimed at testing Smartfloor's seat fixings, the so-called "Smartlegs" on the Smartfloor system floor.

The following vehicles have been tested by TÜV and Smartfloor with regards to anchorage points. Test certificates and Installation Manuals are available at www.smartfloor.eu.



SMART FL**OR**

Adhesives	11
Airline rail	8
AMF Bruns Cassette lift	101
AMF Bruns AL1 Solid lift	92
AMF Bruns AL1 Split platform lift	94
AMF Bruns AL1 Panorama lift	96
AMF Wheelchair and Occupant Restraints Protektor	40
Assembly Kits	78
Automatic shoulder belts	68, 69
Basic profiles	8
Side Step	86
Channel ramps	105
Conversion kits for various brands	109
Cover strips	10
Easypull	76
eFutureSafe	75
Electric belts	50, 60
Electric Side Step	86
Euroramp	90
Fixed seatleg & Seatleg	18
Floor covering	82
Floor end strips	10
Floor plans	12
FutureSafe head & back rest	80
Harness belt	69
Mobile office foldable table	36
Mobile office foldable wall table	38
Mono fitting	70
Mounting brackets	19
NMI Millennium leg	18

Protektor - system Black Series	43
Protektor - system Silver Series	53
Protektor - system Platinum Series	63
Protektor - system Occupant Restraints	67
Ramps	90
Seat legs	17
Shoulder belt	68
Smartfloor Easy XL M1	30
Smartfold seat leg	19
Smartleg	18
Smartleg spacer	18
Smartseat Travel M2/Travel Luxury M2	34
Smartseat Easy M1	22
Smartseat Easy ISOfix M1	24
Smartseat Tip & Fold M1	26
Smartseat Flip-Up M1	28
Smartseat RV M1	32
Spacer profiles	8
Storage boxes	72
Straight rail	8
Stretcher DIN 1789	85
T-bolts	18
Useful products	10
Vehicle matrix	6, 7
Wheelchair restraint systems	40

VW Transporter

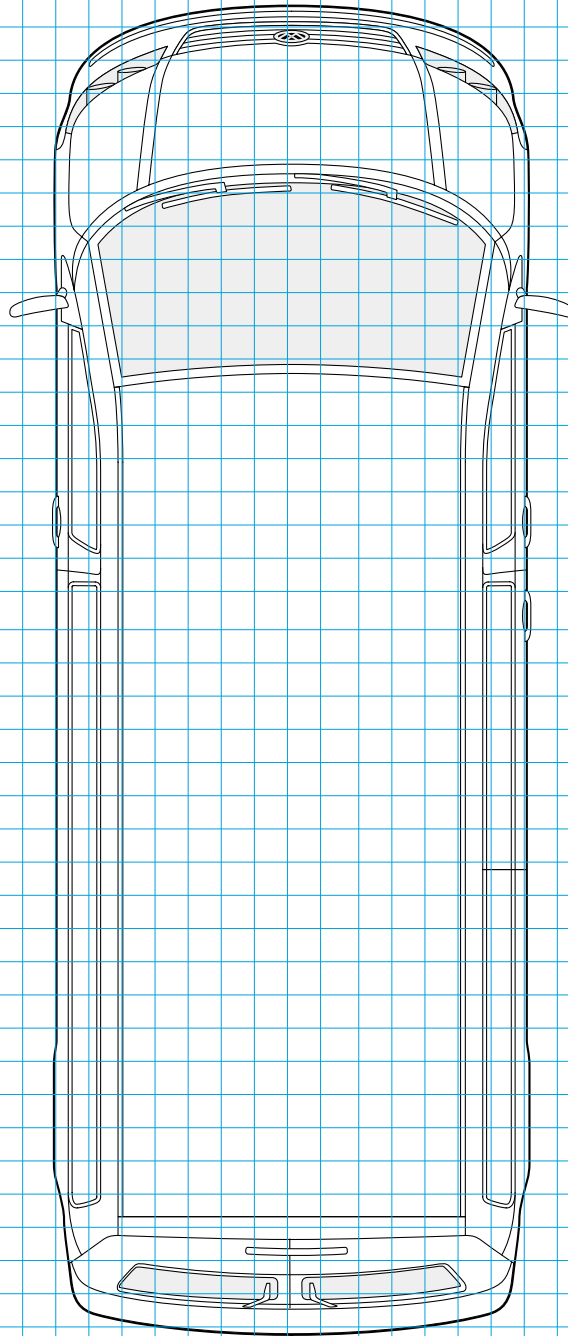

A large grid area for taking notes, consisting of a 30x30 grid of small squares. The grid is light blue and occupies most of the page area below the header bar.

Mercedes Benz Long

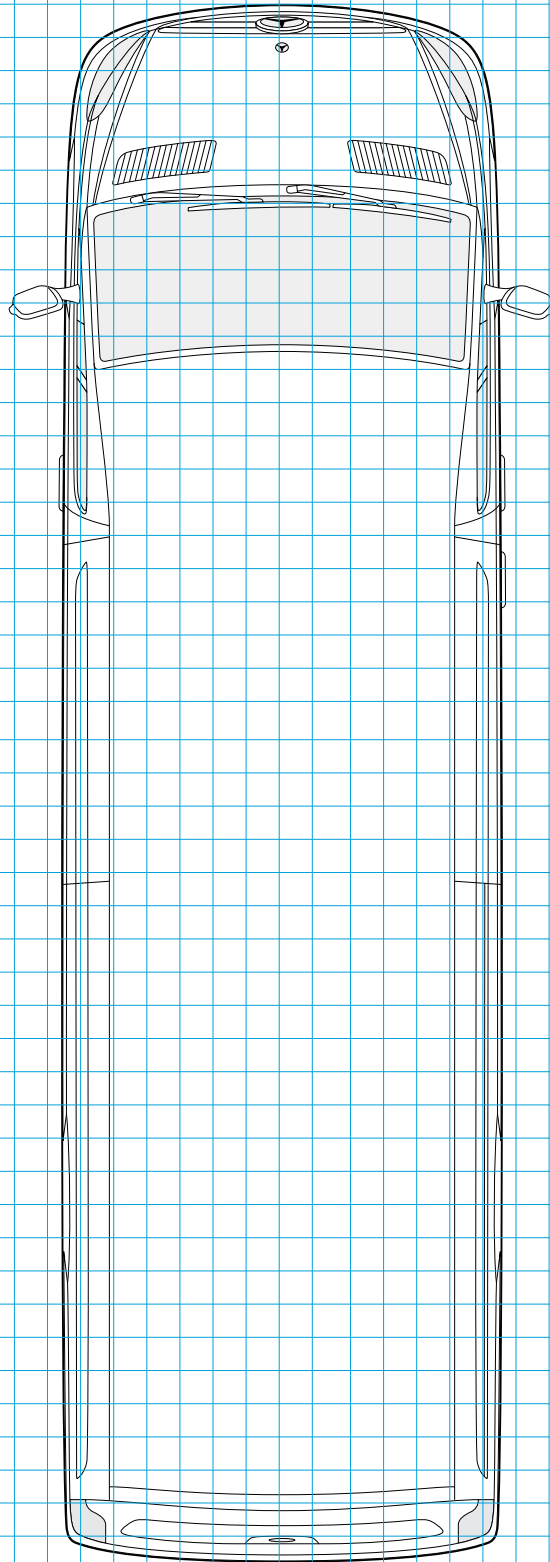

A large grid area for taking notes, consisting of a 30x30 grid of small squares. The grid is light blue and occupies most of the page area below the header bar.

Mercedes Benz Extra Long

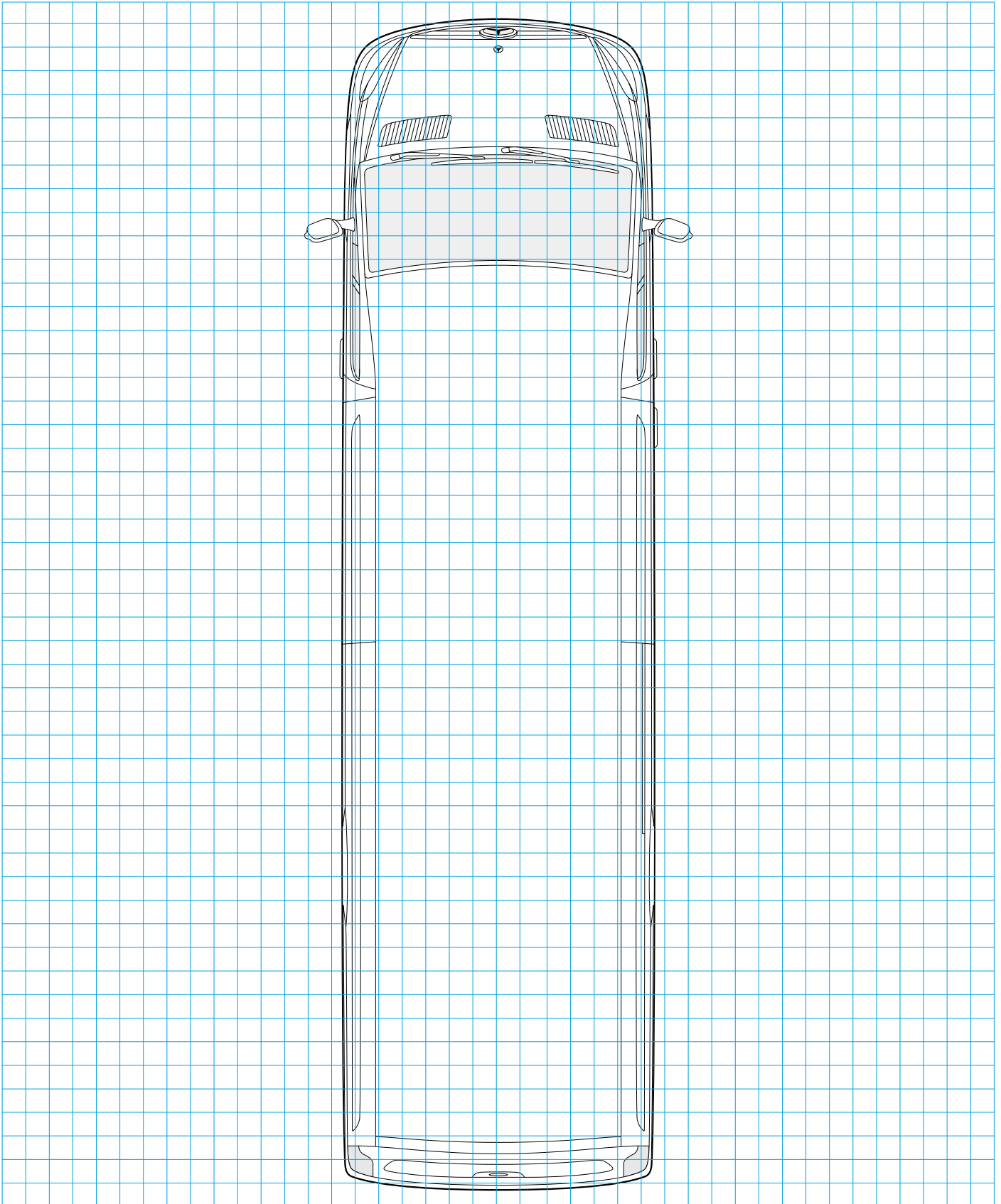

A large grid area for taking notes, consisting of a 30x30 grid of small squares. The grid is light blue and occupies most of the page area below the header bar.

Notes



A series of horizontal blue lines for writing notes, starting below the blue bar and extending to the bottom of the page.



Lined writing area consisting of multiple horizontal blue lines.

SMARTFLOOR

Flexibility inside

Netherlands, Belgium and Luxembourg

SMARTFLOOR B.V.
Veldkampsweg 26
7605 AR Almelo
Nederland
Telefoon : +31 546 45 55 65
www.smartfloor.nl
info@smartfloor.nl

United Kingdom, Ireland

AMF-Bruns UK LTD
Unit 3, Parkway Four
Longbridge Road
Trafford Park
Manchester
M17 1SW
Tel. +44 161 872 7951
www.amf-bruns.com
info@amf-bruns.co.uk

United States of America

AMF-Bruns of America LP
1797 Georgetown Road
Hudson · OH 44236
Phone +1 877 506 3770
www.amfbrunsamerica.com

Germany

AMF-Bruns GmbH & Co. KG
Hauptstraße 101
D-26689 Apen
Postfach 160
D-26689 Apen
Tel. +49 44 89 72 71 01
www.amf-bruns.de
hubmatik@amf-bruns.de

Asia

Smartfloor Seating (Thailand) Co. Ltd
Kunwang Place 165/86
T.:Sanprapao A.: Sansai
Chiang Mai 50210 Thailand

South Africa

AMF-Bruns South Africa
Shoprider
92 Jakaranda Street
Unit # 13 Diamond Park
Hennospark · CENTURION Phone +27 12 653
www.amf-bruns.co.za

