

Bodypoint[®]

STRENGTHEN YOUR POSITION

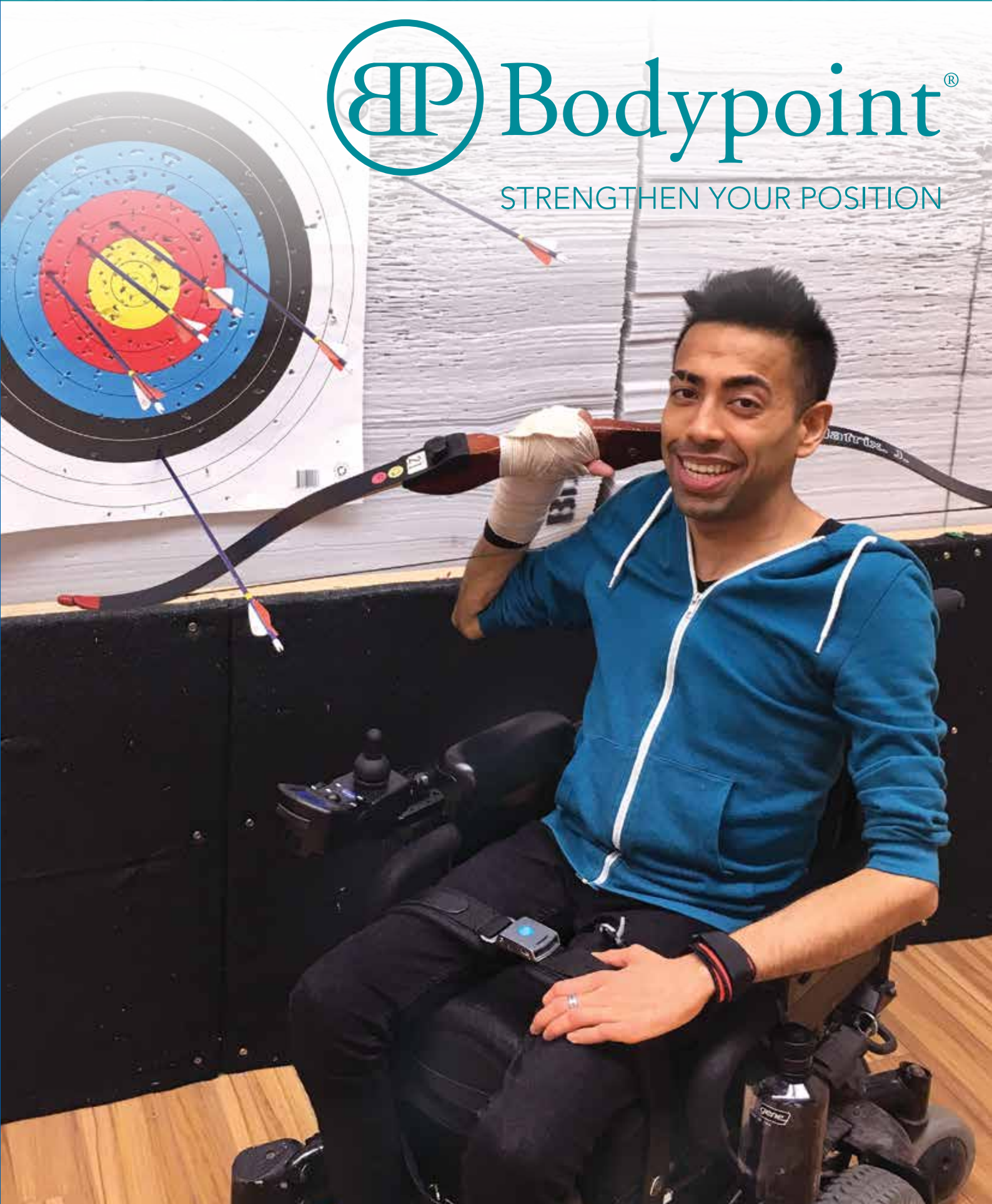

Positioning



champions.

It's personal.

Sometimes the right positioning means a person is able to compete as an Olympic athlete. Sometimes it means relief from pressure sores. Sometimes it enables an upright posture that raises someone's self-esteem. Whatever the reason, positioning has a huge influence on the quality of life for people using wheelchairs.

At Bodypoint®, while we work tirelessly to create extraordinary positioning products, our true mission is always top of mind. We are helping people achieve their full potential. We are champions of positioning.

Table of Contents



4-5
PELVIC POSITIONING
Padded Hip Belts
Evoflex® Pelvic Stabilizer
T-Slot Fastener Kit



6-7
UPPER BODY POSITIONING
Stayflex™ Chest Supports
PivotFit™ Shoulder Harnesses
Trimline Shoulder Harness
Monoflex™ Chest Supports



8
LOWER BODY POSITIONING
Ankle Huggers® Support Straps
Calf Panels and Calf Straps



9
SIZING



Look for this symbol for products tested to the new postural support device wheelchair seating standards.



Learn more at
www.bodypoint.com/standards

Select a Bodypoint® Hip Belt

1 SELECT BELT TYPE



Two-Point Hip Belt

Padded, comfortable support for postural alignment. Simple-to-use and easy to clean.



Four-Point Hip Belt

Assures that the pelvis stays in an aligned, stable position. Extra points keep belt from moving up and riding into the abdomen.



Evoflex® Pelvic Stabilizer

Stiffened straps stay in place for easy buckling and won't get tangled in your wheels. Close fit provides stability and control.

2 SELECT BUCKLE



Push-Button Buckle

Low profile, smooth, snag-free corners. Removable cover for changing release hole size and easy cleaning. Standard Access Cover included. Reduced Access Cover and Security Cover sold separately.

OPTIONAL COVERS:



Reduced Access Cover

FS018D-1 1-1/2", Ø14mm button

For use with M46 belts.

FS019D-1 2", Ø14mm button

For use with L62 belts.



Security Cover

FS018C-1 1-1/2", Ø6mm button

For use with M46 belts.

FS019C-1 2", Ø6mm button

For use with L62 belts.



Side-Release

Lightweight, secure snap action.



Extra Small Metal Push-Button

Strong, secure, child-sized buckle.



Rehab Latch™ Buckle

Lightweight, strong, low profile, easy to operate with limited hand function. Note: Evoflex® Pelvic Stabilizer only.

3 SELECT PULL TYPE



Centre-Pull Hip Belt

For clients with low muscle tone or weakness.



Dual-Pull Hip Belt

For clients requiring greater adjustment to accommodate clothing and weight changes.



Rear-Pull Hip Belt

For clients with high tone. Counters pelvic rotation by allowing the caregiver to position one side of the pelvis, lock it in place and then position on the other side.

4 SELECT A SIZE

See page 9 for sizing and measurement details.

5 SELECT A MOUNTING OPTION



-B2 **Cinch-Mount™**
Time saving, precise, easy adjustment

OR



-B1 **Flat-Mount™**
Versatile, lowest profile

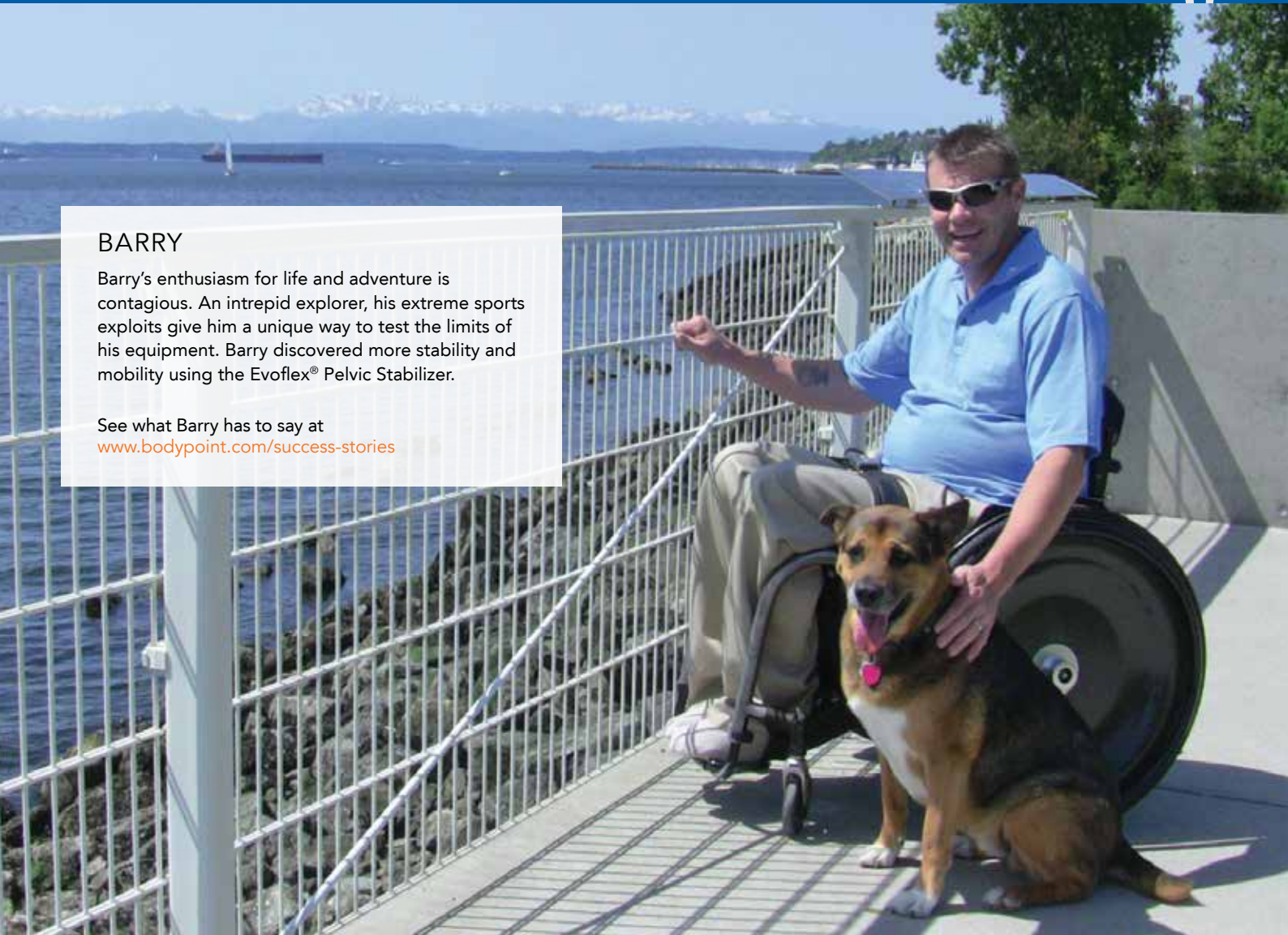

BARRY

Barry's enthusiasm for life and adventure is contagious. An intrepid explorer, his extreme sports exploits give him a unique way to test the limits of his equipment. Barry discovered more stability and mobility using the Evoflex® Pelvic Stabilizer.

See what Barry has to say at www.bodypoint.com/success-stories

6 SELECT PART NUMBER

		TWO-POINT HIP BELTS		EVOFLEX PELVIC STABILIZER		FOUR-POINT HIP BELTS
		Push-Button	Side-Release	Push-Button	Rehab Latch	Push-Button
CENTRE-PULL	XS32	HB235-S32-B1 HB235-S32-B2				
	S38	HB235-S38-B2		EB235S		HB435-S38-B2
	M46	HB205-M46-B1 HB205-M46-B2			EB225M	HB405-M46-B1 HB405-M46-B2
	L62	HB205-L62-B1 HB205-L62-B2			EB225L	HB405-L62-B1 HB405-L62-B2
DUAL-PULL	S38		HB216-S38-B2			
	M46		HB216-M46-B2			
	L62		HB216-L62-B2			
REAR-PULL	S38		HB219-S38-B2			
	M46		HB219-M46-B2			
	L62					

7 OPTIONAL HARDWARE

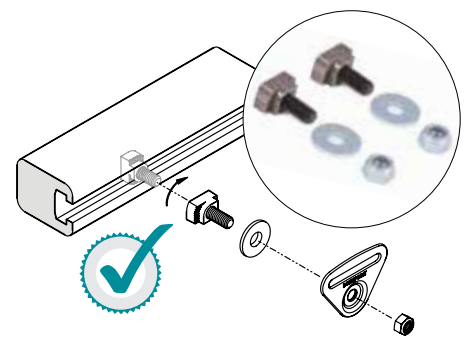

T-Slot Fastener Kit

Direct mount Bodypoint hip belts to Invacare® power wheelchair track rails with the 10mm (1/4") T-slot Fastener Kit. Made out of alloy steel, this easy-to-use kit works with Cinch-Mount™ and Flat-Mount™ End fittings. Used with the Evoflex® Pelvic Stabilizer, it offers a low profile mounting solution. Sold as a pair. **HKA10-1**



JORDAN

Using the PivotFit™ Shoulder Harness, Jordan gained stability and head control. This enables him to successfully operate a head array mouse system for computer use in school and for fun.

Learn more about Jordan at www.bodypoint.com/success-stories

Choose the right



Stayflex™ Chest Support

Provides firm trunk control without sacrificing comfortable shoulder movement.

- Patented “dual zone” elastic construction virtually eliminates upward shifting at the neckline
- Optimal balance between stretch and resistance make it the best choice for long-term stability and performance



Monoflex™ Chest Support

Provides strong, comfortable abdominal/chest support.

- Engineered dynamic padding controls stretch and stabilises even strong spastic tone
- Double-tapered shape distributes pressure across the mid-section



Universal Elastic Strap

Temporary positioning for work, play, sports, therapy or fittings with highly stretchable, strong neoprene that won't damage clothes. Easy-grasp hook-and-loop end tab with a convenient thumb hole for users with limited hand function. To be used for the chest, abdomen, lap or legs. The length (1420 mm) can be cut to size without fraying.

- SP110S Small, 80 mm (3”) high
- SP110L Large, 110 mm (4-1/2”) high
- SP110XL Extra Large, 150 mm (6”) high



support for comfort, fit and function



Bodypoint swivel buckle allows pads to equalize tension for an ideal fit

PivotFit™ Shoulder Harness

Provides shoulder positioning to help users sit upright for easier breathing, better head control and greater stability.

- Body-contouring shape provides optimal support and a comfortable fit
- High-strength swivel buckle allows for precise pad placement for an individual fit
- Available in a non-stretch or a dynamic style



The standard non-stretch model for more aggressive control.



The dynamic model allows controlled movement to reduce spastic tone.



Trimline Shoulder Harness

Gives users support whilst allowing freedom across the chest. Provides the most aggressive approach to shoulder retraction.

- Independent pads and versatile configurations: backpack style or crossed at the sternum
- Tapered pads and a buckle-free front allow a comfortable and modest fit for women



In a backpack configuration, the Trimline gives the greatest amount of shoulder control.



All styles feature front-pull or rear-pull attachment in order to properly address user needs.

Size	STAYFLEX FRONT-PULL			STAYFLEX REAR-PULL		
	Standard Without Zip	FRONT-PULL Narrow with Zip	FRONT-PULL Narrow without Zip	REA-PULL Standard with Zip	REA-PULL Narrow without Zip	REA-PULL Narrow with Zip
XXS						
XS	SH311XS-B2 (or -C2)			SH321XS-B2		
S	SH311S-B2 (or -C2)			SH321S-B2		
M		SH330M-B2 (or -C2)	SH331M-B2 (or -C2)		SH341M-B2	SH340M-B2
L		SH330L-B2 (or -C2)	SH331L-C2 (or -C2)		SH341L-B2	SH340L-B2
XL		SH330XL-B2 (or -C2)	SH331XL-B2 (or -C2)		SH341XL-B2	SH340XL-B2

Size	PIVOTFIT FRONT-PULL		PIVOTFIT REAR-PULL		TRIMLINE	MONOFLEX	
	Standard	Dynamic	Standard	Dynamic		Underarm Release	Two Piece, Center Release
XXS	SH250XXS-B2 (or -C2)	SH270XXS-B2 (or -C2)	SH260XXS-B2	SH280XXS-B2			
XS	SH250XS-B2 (or -C2)	SH270XS-B2 (or -C2)	SH260XS-B2	SH280XS-B2		SH120XS-B3 (or -B1)	SH122XS-B1
S	SH250S-B2 (or -C2)	SH270S-B2 (or -C2)	SH260S-B2	SH280S-B2	SH230S-B2	SH120S-B3 (or -B1)	SH122S-B1
M	SH250M-B2 (or -C2)	SH270M-B2 (or -C2)	SH260M-B2	SH280M-B2	SH230M-B2	SH120M-B3 (or -B1)	SH122M-B1
L	SH250L-B2 (or -C2)	SH270L-B2 (or -C2)	SH260L-B2	SH280L-B2	SH230L-B2	SH120L-B3 (or -B1)	SH122L-B1
XL	SH250XL-B2 (or -C2)	SH270XL-B2 (or -C2)	SH260XL-B2	SH280XL-B2		SH120XL-B3 (or -B1)	SH122XL-B1

As always, a pelvic support should be worn with any anterior support product.
(-C2) - Adjustable Length Top Straps

ADITYA

Aditya likes his equipment to be discrete. The Bodypoint Ankle Huggers support straps hold them securely in place. This prevents his feet from slipping off the footrest due to a spasm or bumps when traveling.

Learn more about Aditya at www.bodypoint.com/success-stories



Ankle Huggers® Support Straps

Sold in pairs. Low-profile ErgoLatch™ with easy hook-and-loop adjustment for the right fit, every time.



Aeromesh® Calf Panel

Features our proprietary Aeromesh® material. Aeromesh® fabric is bonded to a durable stiffener to allow air flow while maintaining shape.



Aeromesh® Padded Calf Straps

Calf Straps provide comfortable support, keeping feet safely on the footplates. Retains its shape for the best pressure distribution and durability.



Leg Harnesses

Robust lower body support for users who slide out of their chairs or have spasticity. The padded strap securely holds the leg at the inner thigh without limiting anterior movement or pressing on the bladder. Can be used with or without a hip belt.

- LH600S* (Small) - 230 mm (9") x 40 mm (1-1/2")
- LH600M* (Medium) - 330 mm (13") x 45 mm (1-3/4")
- LH600L* (Large) - 380 mm (15") x 50 mm (2")

* Available with Cinch-mount or Flat-mount option

Size	ANKLE HUGGERS	CALF PANEL	CALF STRAPS
XS	FT240XS		
S	FT240S	SP103S	SP102S
M	FT240M	SP103M	SP102M
L	FT240L	SP103L	SP102L
XL	FT240XL		



Hip Belts and Evoflex® Pelvic Stabilizer

1. Determine the most effective position for the belt.
2. Using a flexible tape measure, measure the distance over the body. This corresponds to the belt's padded length (measurement B).
3. Select the belt size.

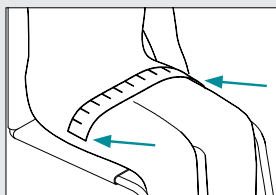

Belt Size	Range
S38	30-38cm (12-15")
M46	39-46cm (15-1/2 - 18")
L62	47-62cm (18-1/2 - 24-1/2")



Watch videos to learn more at www.youtube.com/user/BodypointInc

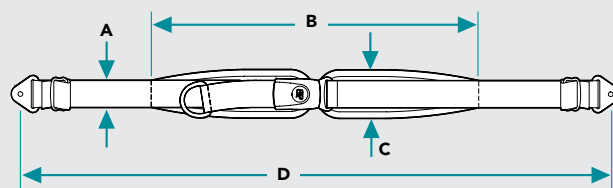

Product Measurements for Hip Belts

Size	A	B	C	D
S38	2.5cm (1")	38cm (15")	5cm (2")	117cm (46")
M46	4cm (1-1/2")	46cm (18")	6cm (2-1/4")	142cm (56")
L62	5cm (2")	62cm (24-1/2")	7cm (2-3/4")	155cm (61")

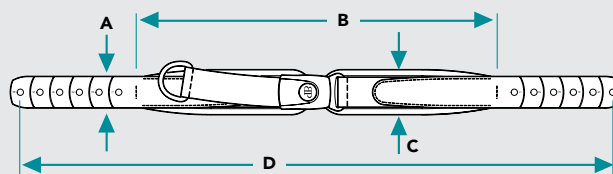

Product Measurements for Evoflex® Pelvic Stabilizers

Size	A	B	C	D
S38	2.5cm (1")	38cm (15")	5cm (2")	63cm (24-3/4")
M46	4cm (1-1/2")	46cm (18")	6cm (2-1/4")	76cm (29-3/4")
L62	5cm (2")	62cm (24-1/2")	7cm (2-3/4")	96cm (37-3/4")

Stayflex™, PivotFit™ and Trimline Shoulder Harnesses

Measure shoulder width. If the shoulder width falls between two sizes, consider other factors such as growth, weight changes, and clothing.

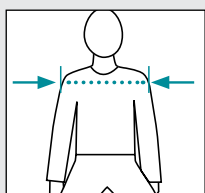

Size	Shoulder Width
XS	24-28cm (9-1/2-11")
S	28-33cm (11-13")
M	33-41cm (13-16")
L	41-48cm (16-19")
XL	48-56cm (19-22")

Monoflex™

Measure the user's trunk around the front and sides at the height at which the Monoflex™ will be worn. Refer to the fit range chart.

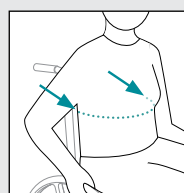

Size	Min/Max Fit Range
XS	36-45cm (14-17-1/2")
S	46-55cm (18-21-1/2")
M	56-65cm (22-25-1/2")
L	66-75cm (26-29-1/2")
XL	76-85cm (30-33-1/2")

Aeromesh® Calf Supports

For proper fit, measure chair width.

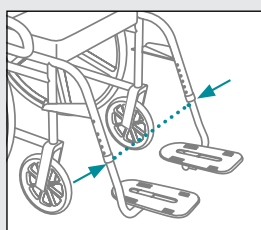

S	31cm-38cm (12-15")
M	38cm-48cm (15-19")
L	48cm-56cm (19-22")

Ankle Huggers® Support Straps

Measure circumference above ankle.

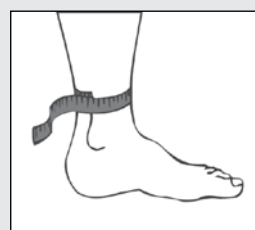

XS	14cm-17cm (5-1/2-6-3/4")
S	16.5cm-20cm (6-1/2-8")
M	19cm-23.5cm (7-1/2-9-1/4")
L	23cm-28cm (9-11")
XL	26.5cm-33cm (10-1/2-13")

	Stock Code	Description	
Hip Belts			
HB205 series			
	HB205-M46-B1	Hip Belt, Ctr-Pull, PB	M x 46cm Pads, F-Mt
	HB205-M46-B2	Hip Belt, Ctr-Pull, PB	M x 46cm Pads, C-Mt
	HB205-L62-B1	Hip Belt, Ctr-Pull, PB	L x 62cm Pads, F-Mt
	HB205-L62-B2	Hip Belt, Ctr-Pull, PB	L x 62cm Pads, C-Mt
HB405 series			
	HB405-M46-B1	Hip Belt, 4-pt, Ctr-Pull, PB	M x 46cm Pads, F-Mt
	HB405-M46-B2	Hip Belt, 4-pt, Ctr-Pull, PB	M x 46cm Pads, C-Mt
	HB405-L62-B1	Hip Belt, 4-pt, Ctr-Pull, PB	L x 62cm Pads, F-Mt
	HB405-L62-B2	Hip Belt, 4-pt, Ctr-Pull, PB	L x 62cm Pads, C-Mt
HB216			
	HB216-S38-B2	Hip Belt, Dual-Pull, SR	S x 38cm Pads, C-Mt
	HB216-M46-B2	Hip Belt, Dual-Pull, SR	M x 46cm Pads, C-Mt
	HB216-L62-B2	Hip Belt, Dual-Pull, SR	L x 62cm Pads, C-Mt
HB219			
	HB219-S38-B2	Hip Belt, Rear-Pull, SR	S x 38cm Pads, C-Mt
	HB219-M46-B2	Hip Belt, Rear-Pull, SR	M x 46cm Pads, C-Mt
HB235 series			
	HB235-S38-B2	Hip Belt, Ctr-Pull, PB	S x 38cm Pads, C-Mt
	HB235-S32-B1	Hip Belt, Ctr-Pull PBX	Small, Flat Mt
	HB235-S32-B2	Hip Belt, Ctr-Pull PBX	Small, Cinch-Mt
HB435 series			
	HB435-S38-B2	Hip Belt, 4-pt, Ctr-Pull, PB	S x 38cm Pads, C-Mt
	EB235XS	Evoflex Pelvic Stabilizer	X-Small, PB
	EB225M	Evoflex Pelvic Stabilizer	Medium, Latch
	EB225L	Evoflex Pelvic Stabilizer	Large, Latch
	EB235S	Evoflex Pelvic Stabilizer, PB	Small x38cm pads
	FS018D-1	Push Button Reduced Access Cover	1-1/2", Ø14mm Hole, Gr
	FS019D-1	Push Button Reduced Access Cover	2", Ø14mm Hole, Gr
	FS018C-1	Push Button Security Cover	1-1/2", Ø6mm Hole, Gray
	FS019C-1	Push Button Security Cover	2", Ø6mm Hole, Gray
	FS029C-1	Push Button Security Cover	1" PB Buckle



Push buckle



Push buckle



Side-release buckle



Side-release buckle



XS Push buckle



XS Push buckle



M/L Rehab Latch buckle



Shoulder Harnesses/chest belts

Monoflex			
	SH120XS-B3	Monoflex, Front-Pull	X-Small, Grommet Stp
	SH120S-B3	Monoflex, Front-Pull	Small, Grommet Strap
	SH120M-B3	Monoflex, Front-Pull	Medium, Grommet Strap
	SH122L-B1	Monoflex, Ctr Rel.	Large, 2-PC, Flat-Mount
	SH122M-B1	Monoflex, Ctr Rel.	Medium, 2-PC, Flat-Mount
	SH122S-B1	Monoflex, Ctr Rel.	Small, 2-PC, Flat-Mount
	SH122XL-B1	Monoflex, Ctr Rel.	X-Large, 2-PC, Flat-Mount
	SH122XS-B1	Monoflex, Ctr Rel.	X-Small, 2-PC, Flat-Mount
	SH120L-B3	Monoflex, Front-Pull	Large, Grommet Strap





	Stock Code	Description	
	SH120XL-B3	Monoflex, Front-Pull	X-Large, Grommet Stp
	SH120L-B1	Monoflex, Underarm Release	
	SH120M-B1	Monoflex, Underarm Release	
	SH120S-B1	Monoflex, Underarm Release	
	SH120XL-B1	Monoflex, Underarm Release	
	SH120XS-B1	Monoflex, Underarm Release	
PivotFit			
	SH250S-B2	PivotFit Shoulder Harness	Small, Fr-Pull, C-Mt
	SH250M-B2	PivotFit Shoulder Harness	Medium, Fr-Pull, C-Mt
	SH250L-B2	PivotFit Shoulder Harness	Large, Front-Pull, C-Mt
	SH250XL-B2	PivotFit Shoulder Harness	X-Large, Fr-Pull C-Mt
	SH250XS-B2	PivotFit Shoulder Harness	X-Small, Fr-Pull, C-Mt
	SH250XXS-B2	PivotFit Shoulder Harness	XX-Small, w/CM096
	SH250L-C2-B2	PivotFit Shoulder Harness	Large, Frnt-Pll, Ad. Length top straps
	SH250M-C2-B2	PivotFit Shoulder Harness	Medium, Frnt-Pll, Ad. Length top straps
	SH250S-C2-B2	PivotFit Shoulder Harness	Small, Frnt-Pll, Ad. Length top straps
	SH250XL-C2-B2	PivotFit Shoulder Harness	X-Large, Frnt-Pll, Ad. Length top straps
	SH250XS-C2-B2	PivotFit Shoulder Harness	X-Small, Frnt-Pll, Ad. Length top straps
	SH250XXS-C2-B2	PivotFit Shoulder Harness	XX-Small, Frnt-Pll, Ad. Length top straps
	SH270L-B2	PivotFit Dynamic Shldr Hrness	Large, Front-Pull, C-Mt
	SH270M-B2	PivotFit Dynamic Shldr Hrness	Medium, Front-Pull C-Mt
	SH270S-B2	PivotFit Dynamic Shldr Hrness	Small, Front-Pull, C-Mt
	SH270XL-B2	PivotFit Dynamic Shldr Hrness	X-Large, Frnt-Pull C-Mt
	SH270XS-B2	PivotFit Dynamic Shldr Hrness	X-Small, Frnt-Pull C-Mt
	SH270XXS-B2	PivotFit Dynamic Shldr Hrness	XX-Small, Frnt-Pll C-Mt
	SH270L-C2-B2	PivotFit Dynamic Shldr Hrness	Large, Frnt-Pll, Ad. Length top straps
	SH270M-C2-B2	PivotFit Dynamic Shldr Hrness	Medium, Frnt-Pll, Ad. Length top straps
	SH270S-C2-B2	PivotFit Dynamic Shldr Hrness	Small, Frnt-Pll, Ad. Length top straps
	SH270XL-C2-B2	PivotFit Dynamic Shldr Hrness	X-Large, Frnt-Pll, Ad. Length top straps
	SH270XS-C2-B2	PivotFit Dynamic Shldr Hrness	X-Small, Frnt-Pll, Ad. Length top straps
	SH270XXS-C2-B2	PivotFit Dynamic Shldr Hrness	XX-Small, Frnt-Pll, Ad. Length top straps
	SH260L-B2	PivotFit™ Shoulder Harness	Large, Rear Pull
	SH260M-B2	PivotFit™ Shoulder Harness	Medium, Rear Pull
	SH260S-B2	PivotFit™ Shoulder Harness	Small, Rear Pull
	SH260XL-B2	PivotFit™ Shoulder Harness	X-Large, Rear Pull
	SH260XS-B2	PivotFit™ Shoulder Harness	X-Small, Rear Pull
	SH260XXS-B2	PivotFit™ Shoulder Harness	XX-Small, Rear Pull



Shoulder Harness

	Stock Code	Description	
	SH280L-B2	PivotFit™ Dynamic Shldr Hrness	Large, Rear Pull
	SH280M-B2	PivotFit™ Dynamic Shldr Hrness	Medium, Rear Pull
	SH280S-B2	PivotFit™ Dynamic Shldr Hrness	Small, Rear Pull
	SH280XL-B2	PivotFit™ Dynamic Shldr Hrness	X-Large, Rear Pull
	SH280XS-B2	PivotFit™ Dynamic Shldr Hrness	X-Small, Rear Pull
	SH280XXS-B2	PivotFit™ Dynamic Shldr Hrness	XX-Small, Rear Pull
Stayflex			
	SH311XS-B2	Stayflex, Std, Front-Pull	X-Small, w/o zip, C-Mt,
	SH311S-B2	Stayflex, Std, Front-Pull	Small, w/o zip, C-Mt
	SH330M-B2	Stayflex, Narrow, Front-Pull	Medium, w/zip, C-Mt,
	SH330L-B2	Stayflex, Narrow, Front-Pull	Large, w/zip, C-Mt
	SH330XL-B2	Stayflex, Narrow, Front-Pull	X-Large, w/zip, C-Mt
	SH331L-B2	Stayflex, Narrow, Front-Pull	Large w/o zip, C-Mt
	SH331M-B2	Stayflex, Narrow, Front-Pull	Medium w/o zip, C-Mt
	SH331XL-B2	Stayflex, Narrow, Front-Pull	X-Large w/o zip, C-Mt
	SH311S-C2-B2	Stayflex, Std, Front-Pull	Small
	SH311XS-C2-B2	Stayflex, Std, Front-Pull	X-Small
	SH321S-B2	Stayflex™, Std, Rear-Pull	Small
	SH321XS-B2	Stayflex™, Std, Rear-Pull	X-Small
	SH330L-C2-B2	Stayflex, Narrow, Front-Pull	Large
	SH330M-C2-B2	Stayflex, Narrow, Front-Pull	Medium
	SH330XL-C2-B2	Stayflex, Narrow, Front-Pull	X-Large
	SH340L-B2	Stayflex™, Narrow, Rear-Pull	Large
	SH340M-B2	Stayflex™, Narrow, Rear-Pull	Medium
	SH340XL-B2	Stayflex™, Narrow, Rear-Pull	X-Large
	SH331L-C2-B2	Stayflex, Narrow, Front-Pull	Large
	SH331M-C2-B2	Stayflex, Narrow, Front-Pull	Medium
	SH331XL-C2-B2	Stayflex, Narrow, Front-Pull	X-Large
	SH341L-B2	Stayflex™, Narrow, Rear-Pull	Large
	SH341M-B2	Stayflex™, Narrow, Rear-Pull	Medium
	SH341XL-B2	Stayflex™, Narrow, Rear-Pull	X-Large
Trimline			
	SH230S-B2	Shoulder Harness, Front-Pull	Small, Trimline, C-Mt
	SH230M-B2	Shoulder Harness, Front-Pull	Medium, Trimline, C-Mt
	SH230L-B2	Shoulder Harness, Front-Pull	Large, Trimline, C-Mt
Universal Elastic Strap			
	SP110S	Elastic Strap	Small (width 80 mm)
	SP110L	Elastic Strap	Large (width 110 mm)
	SP110XL	Elastic Strap	Extra Large (width 150 mm)



StayFlex Standard, Rear Pull



StayFlex Narrow, Rear Pull



StayFlex Narrow, Rear Pull

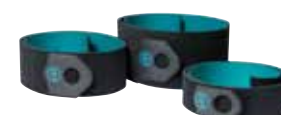



	Stock Code	Description	
Ankle harnesses/calf support			
Ankle hugger			
	FT240XS	Ankle Huggers	X-Small, w/ Mt. Kit
	FT240S	Ankle Huggers	Small, w/ Mt. Kit
	FT240M	Ankle Huggers	Medium, w/ Mt. Kit
	FT240L	Ankle Huggers	Large, w/ Mt. Kit
	FT240XL	Ankle Huggers	X-Large, w/ Mt. Kit
Calf Strap			
	SP102S	Calf Strap, Aeromesh	Small, 32"
	SP102M	Calf Strap, Aeromesh	Medium, 36"
	SP102L	Calf Strap, Aeromesh	Large, 40"
Calf Panel			
	SP103S	Calf Panel, Aeromesh	Small, 32-1/2"
	SP103M	Calf Panel, Aeromesh	Medium, 35-1/2"
	SP103L	Calf Panel, Aeromesh	Large, 38-1/2"
Leg Harness			
	LH600L-B2	Leg Harness, SR	Large, C-Mt, Pair
	LH600M-B2	Leg Harness, SR	Medium, C-Mt, Pair
	LH600S-B2	Leg Harness, SR	Small, C-Mt, Pair
	LH600L-B1	Leg Harness, SR	Large, Flat-Mt, Pair
	LH600M-B1	Leg Harness, SR	Medium, Flat-Mt, Pair
	LH600S-B1	Leg Harness, SR	Small, Flat-Mt, Pair
Hardware			
	HKA10-1	T-Slot Fastener Kit	M6x 14 for 10mm T-Slot, Pr
	HW303-B-2	Framesaver Clamp	22mm shim, M6 screw, pkg 2
	HW200-20-2	Seat Mounting Bracket 20° Bend	1 Pair w/ Fasteners
	HW200-90-2	Seat Mounting Bracket 90° Bend	1 Pair w/ Fasteners
	HW320-25-10	Band Clamp 25mm	Stainless Steel Pk of 10
	HW320-25-2	Band Clamp 25mm	Stainless Steel Pk of 2
	HW320-30-10	Band Clamp 30mm	Stainless Steel Pk of 10
	HW320-30-2	Band Clamp 30mm	Stainless Steel Pk of 2
	HKA12-1	Belt Mounting Extension Kit	
	HW320-22-2	Band Clamp 22mm	Stainless Steel Pk of 2
Bodypoint Joystick handles for Invacare Power wheelchairs			
	PC101A	Joystick Handle, 3" U-Shaped	
	PC102A	Joystick Handle, 4" U-Shaped	
	PC107A	Joystick Handle, Rubber Dome	
	PC110A	Grooved Mushroom	
Manual Wheelchairs Accessory			
	SP001	Bodypoint® Mobility Bag	



Framesaver Clamp



Seat Mounting Bracket 20° / 90°

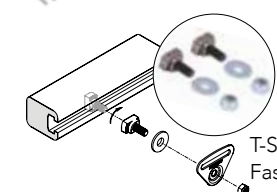

T-Slot Fastener Kit



Belt Mounting Extension Kit



Band Clamp



Joystick Handle U-Shaped



Grooved Mushroom



Joystick Handle Rubber Dome



Mobility Bag

Invacare International GmbH
Benkenstrasse 260
4108 Witterswil
Switzerland
Tel: +41 (0) 61 487 70 70
hgeurope@invacare.com
www.invacare.eu.com



Yes, you can.®