

SMARTFLOOR PRODUCTS 2023

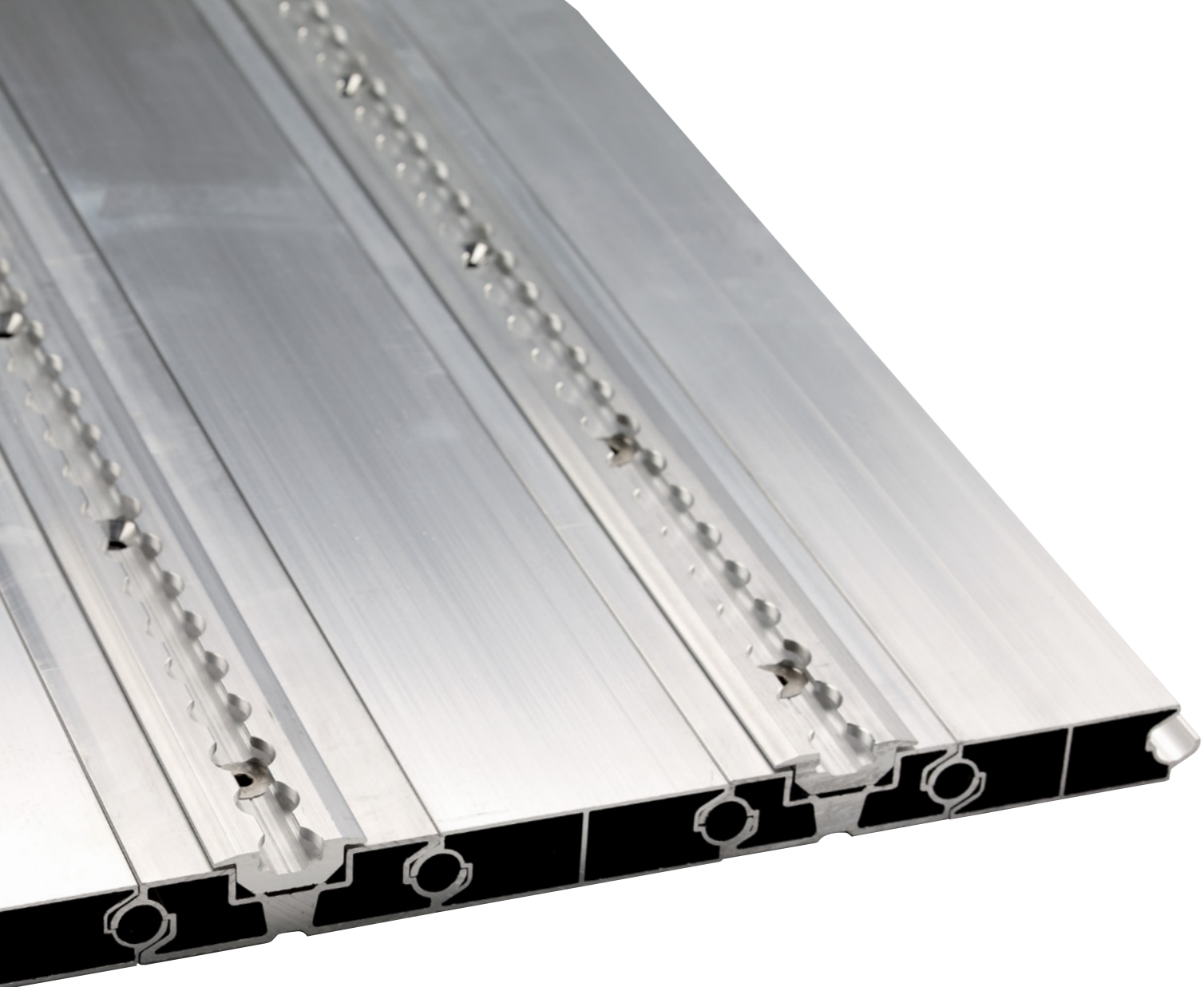

Member of AMF-Bruns group

SMARTFLOOR
Flexibility inside



SMART FLOOR

Flexibility inside

CONTENT

1	Vehicle Matrix	6
2	Profiles	8
3	Useful Products	10
4	Floor Plans	12
5	Seat Legs	16
6	Smart Swivels	19
7	Seats	22
8	Wheelchair and Occupant Restraints Protektor	38
9	Head & Back rests / Seatbelt Anchorage	66
	Easypull	68
	Assembly Kits shoulderbelt	70
	FutureSafe	72
	eFutureSafe	75
9	Floor covering	76
10	Stretcher	79
11	Side Steps, Ramps and Lifts	81
12	Cassette Lifts, Channel Ramps, Lowering Suspension	86
13	Conversion Kits	104
14	Test centre	106
	Vehicle tests	
15	Index	110
	Notes & Your Vehicle Plans	112

The products and conversions shown are representatives of those available. However they may not suit all markets.

Smartfloor holds the right to edit, delete, or modify any information at their own discretion. We take great care in checking information shown for accuracy, but no warranty is implied or given by us. Smartfloor is not responsible for typographical errors, mistakes or misprints.

2023 | GS-080-0100-EN/Rev08/01.11.23



Download the free universal app and design your own vehicle lay-out on your iPad. View vehicle lay-out as designed by yourself with top, side and front views. Forward by e-mail your designed lay-outs.



Introduction

Flexibility Inside

The market for wheelchair and standard passenger transportation is always on the move. Multifunctionality is key to delivering good profits in the minibus business. Custom coachbuilders know this better than anybody else. And you know that calls for flexible configurations and quick conversions. Smartfloor sets the pace in this market with RDW, TÜV and VCA approved modular lightweight floors and accessories.

The leading supplier

For over 20 years Smartfloor has been the leading supplier in the Europe for robust, durable lightweight floor components and accessories for minibus taxis. Smartfloor offers safe and flexible solutions for all makes and models. Ingenious attachment technologies allow minibus taxis to be switched over in no time at all from a standard multi-passenger to a wheelchair transportation configuration. And it's just as easy to fit comfortable VIP seats.

Complete

The basis of Smartfloor solutions are formed by three innovative and modular floor systems with guide rails. Thanks to good contacts with importers and manufacturers Smartfloor enjoys on-going access to the most up-to-date and accurate technical data for almost all minibuses, so our lightweight floors always fit properly and anybody can install them easily on their own. As well as the innovative floor components Smartfloor offers a range of accessories such as seats, wheelchair systems and lifts.

Safety first

Smartfloor considers the safety of wheelchair users of paramount importance. This safety is key in all product and system innovations. Smartfloor has a well-equipped in-house test centre that is suitable for research and approval tests. Smartfloor floors are M1 certified according to UN/ECE R14, R16 and R17 for all major bus makes. Smartfloor wheelchair fastening systems comply with all international standards and the ISO 10542 standard. The key starting point is to make sure the installation is done in line with Smartfloor's instructions. Never forget: 'safety first'!

Easy to install

Our manuals tell you clearly how to install Smartfloor products and accessories safely and quickly. Contact us and we will send them to you at no charge.

The products and conversions shown are representatives of those available. However they may not suit all markets.

Item code	Item name	Width	3.360 mm	3.700 mm	4.500 mm	Item code	Item name	Width	5.500 mm
S22001	Profile Smartfloor basic 78	78 mm	•			S22235	Profile Smartfloor basic 78	78 mm	•
S22005	Profile Smartfloor basic 95	95 mm	•			S22240	Profile Smartfloor basic 95	95 mm	•
S22006	Profile Smartfloor basic 234	234 mm	•			S22243	Profile Smartfloor basic 234	234 mm	•
S22009	Profile Smartfloor basic 268	268 mm	•			S22244	Profile Smartfloor basic 268	268 mm	•
S22007	Profile Smartfloor double basic 156 (234)	234 mm	•			S22241	Profile Smartfloor double basic 156 (234)	234 mm	•
S22008	Profile Smartfloor double basic 173 (251)	251 mm	•			S22242	Profile Smartfloor double basic 173 (251)	251 mm	•
S22010	Profile Smartfloor spacer 78	78 mm	•			S22245	Profile Smartfloor spacer 78	78 mm	•
S22015	Profile Smartfloor spacer 95	95 mm	•			S22250	Profile Smartfloor spacer 95	95 mm	•
S22020	Profile Smartfloor spacer 173	173 mm	•			S22255	Profile Smartfloor Spacer 173	173 mm	•
S22021	Side profile Smartfloor left		•			S22260	Profile Smartfloor straight rail		•
S22022	Side profile Smartfloor right		•			S22265	Profile Smartfloor airline rail		•
S22025	Profile Smartfloor straight rail		•						
S22030	Profile Smartfloor airline rail		•						
S22201	Profile Smartfloor basic 78	78 mm		•					
S22205	Profile Smartfloor basic 95	95 mm		•					
S22206	Profile Smartfloor basic 234	234 mm		•					
S22209	Profile Smartfloor basic 268	268 mm		•					
S22207	Profile Smartfloor double basic 156 (234)	234 mm		•					
S22208	Profile Smartfloor double basic 173 (251)	251 mm		•					
S22210	Profile Smartfloor spacer 78	78 mm		•					
S22215	Profile Smartfloor spacer 95	95 mm		•					
S22220	Profile Smartfloor spacer 173	173 mm		•					
S22225	Profile Smartfloor straight rail			•					
S22230	Profile Smartfloor airline rail			•					
S22035	Profile Smartfloor basic 78	78 mm			•				
S22040	Profile Smartfloor basic 95	95 mm			•				
S22043	Profile Smartfloor basic 234	234 mm			•				
S22044	Profile Smartfloor basic 268	268 mm			•				
S22041	Profile Smartfloor double basic 156 (234)	234 mm			•				
S22042	Profile Smartfloor double basic 173 (251)	251 mm			•				
S22045	Profile Smartfloor spacer 78	78 mm			•				
S22050	Profile Smartfloor spacer 95	95 mm			•				
S22055	Profile Smartfloor spacer 173	173 mm			•				
S22056	Side profile Smartfloor left				•				
S22057	Side profile Smartfloor right				•				
S22060	Profile Smartfloor straight rail				•				
S22065	Profile Smartfloor airline rail				•				

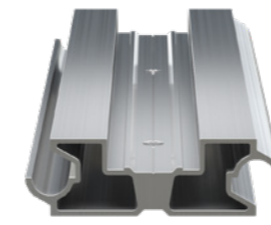

Profile Smartfloor basic 78

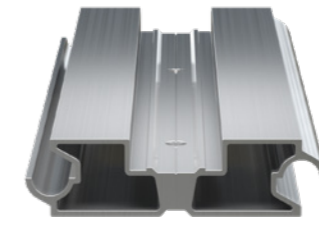

Profile Smartfloor basic 95

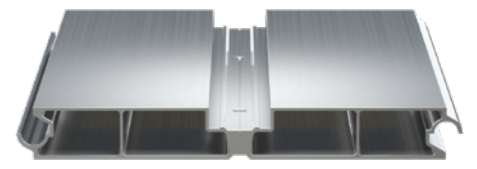

Profile Smartfloor single basic 234

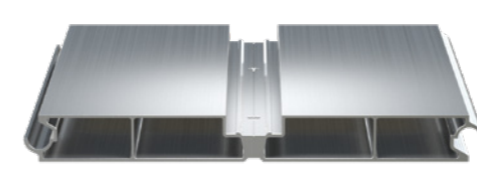

Profile Smartfloor single basic 268

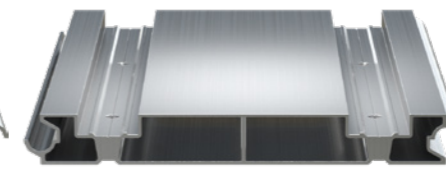

Profile Smartfloor double basic 156 (234)

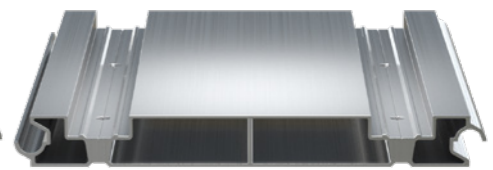

Profile Smartfloor double basic 173 (251)

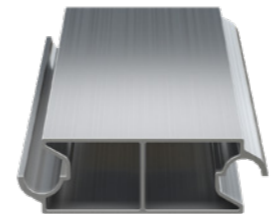

Profile Smartfloor spacer 78

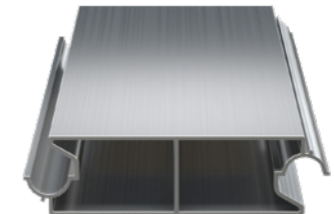

Profile Smartfloor spacer 95

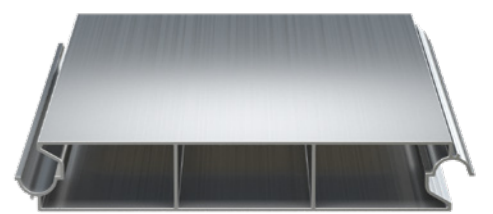

Profile Smartfloor spacer 173



Endprofile left



Endprofile right



Profile Smartfloor airline rail



Profile Smartfloor straight rail

Rail inserts

Item code	Item name
	
10024457	Cover strip rubber black
H150352	Cover strip rubber grey

Floor end cover strip stainless steel

Item code	Item name
10007174	Sprinter/Crafter
200470608	Crafter/TGE front
200470557	Crafter/TGE back
10023098	Plastic cover for entrance, Crafter/TGE

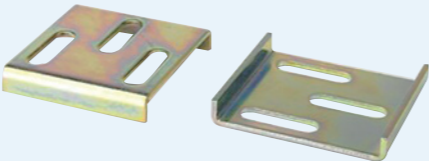

Miscellaneous

Item code	Item name	Content	Length
10002002	Bolt M10*25 A2 Stainless steel		25 mm
10003833	Bolt M10*60 A2 Stainless steel		60 mm
10013214	Bolt M10*200 A2 Stainless steel		200 mm
H22075	Plastic assembly plug		
S22080	Lock plate		

Item code	Item name	Content	Description
10022567	Sikaflex - 552 AT (white)	600 ml	
10022568	Sika Aktivator 205	1000 ml	
20001033	Sika Sense 4615 Adhesive for carpets and vinyls.	24 KG	
20001032	Sikaflex dispenser		
S00011	Gloves polkadot size 10	12 sets	Category 1 
10020774	Smartfloor dome sticker		
S00013	Smartfloor warning window sticker		

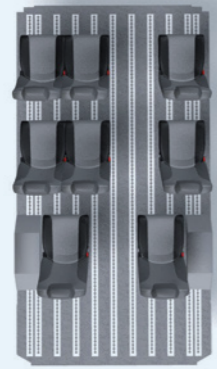

8 seats

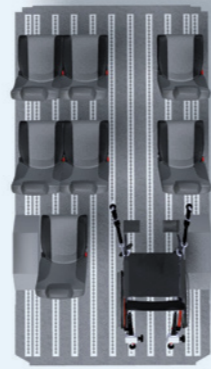

7 seats and 1 wheelchair



8 folding seats



6 folding seats and 1 wheelchair



Smartfloor
Designer

DOWNLOAD THE APP • iPad only

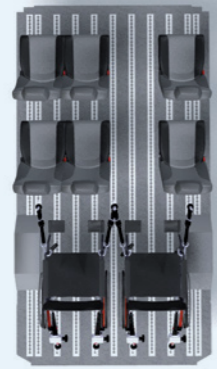

6 seats and 2 wheelchairs

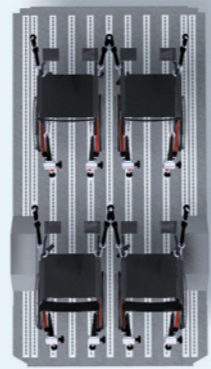

4 wheelchairs

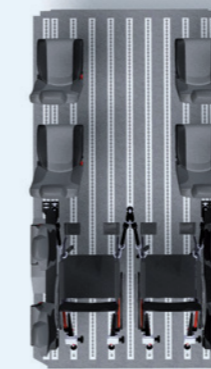

4 seats and 2 wheelchairs

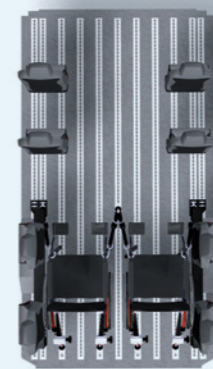

4 folding seats and 2 wheelchairs



6 seats and 2 wheelchairs

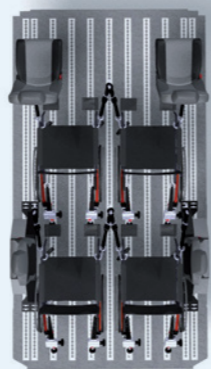

2 seats and 4 wheelchairs

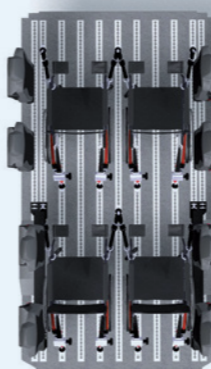

4 wheelchairs



4 wheelchairs

The Smartfloor plans shown are representatives of those available. However they may not suit all markets.

The Smartfloor plans shown are representatives of those available. However they may not suit all markets.



Smartfloor seat legs are especially designed for intensive use in passenger transport vehicles. Thanks to various spacers, the lightweight Smartleg seat leg can be suited to fit all rail widths in Smartfloor floors. Smartfloor seat legs are easy to install underneath all types of seats from renowned European manufacturers. All seat legs can be delivered with a wheel at the back as an option to provide the highest possible convenience when having to change position or remove seats in wheelchair transport on a regular basis.

- Various spacers to suit every desired rail distance.
- Highly suitable for all M1 and M2 seat types
- Smartleg can be delivered separately or with mounted spacer
- RDW tested on Smartfloor floors in combination with M1 and M2 seats
- Optional wheel at the back for easy manoeuvring in and out of the vehicle
- Robust lightweight construction
- Mounting parts can be delivered as a separate option
- Also available with folding mechanism

Quick locking systems

- 10011973 Smartleg 290 mm
- 10012833 Smartleg 290 mm including Wheelie Wheel
- 10020739 Smartleg 330 mm
- 10020740 Smartleg 330 mm including Wheelie Wheel
- 10020741 Smartleg 360 mm
- 10020742 Smartleg 360 mm including Wheelie Wheel
- 10014449 Smartleg 390 mm
- 92191400 Millenniumleg 280 mm with spigot
- 92191402 Millenniumleg 280 mm with spigot, Wheelie Wheel
- 92191500 Millenniumleg 235 mm with spigot
- 92182100 Millenniumleg 235 mm with spigot, Wheelie Wheel
- 92191600 Millenniumleg 335 mm with spigot
- 10011974 Smartleg spacer 156 mm
- 10013476 Smartleg spacer 164.5 mm
- 10013477 Smartleg spacer 173 mm
- 10013478 Smartleg spacer 181.5 mm
- 10013479 Smartleg spacer 190 mm
- 10013480 Smartleg spacer 234 mm
- 10013482 Smartleg spacer 251 mm



Fixed mounting

- 10014361 Smartleg 290 mm Fixed
- 10025100 Fixed Leg 290 TN
- 10025101 Fixed Leg 330 TN
- 10025102 Fixed Leg 360 TN



T-bolts / T-Nuts

- 10011522 T-Bolt single M10
- 10011523 T-Bolt double 25 mm M10
- 10011524 T-Bolt double 35 mm M10
- 10011525 T-Bolt double 76 mm M10
- 10024632 T-nut single M8
- 10024633 T-nut double M8

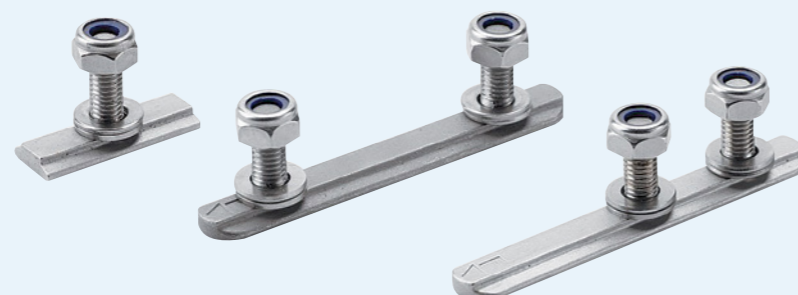

Mounting brackets

- 10020102 Mounting bracket Kit 30 x 30 mm Smartleg/Smartfold
- 10020103 Mounting bracket Kit 30 x 30 mm Fixed leg
- 20001208 Mounting bracket 30 x 30 mm



Lockables

- 10011173 AMF Lockable
- 10024830 Smartfloor Lockable

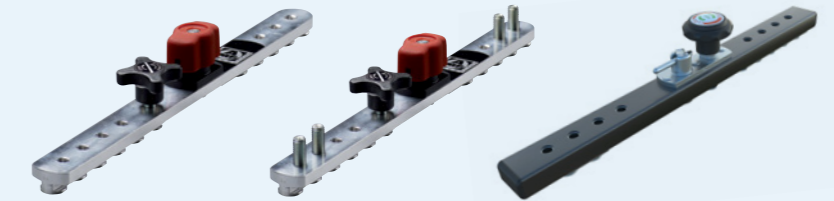

Folding mechanism

- 10013493 Smartfold seat leg 156 mm right hand side control
- 10015967 Smartfold seat leg 156 mm left hand side control

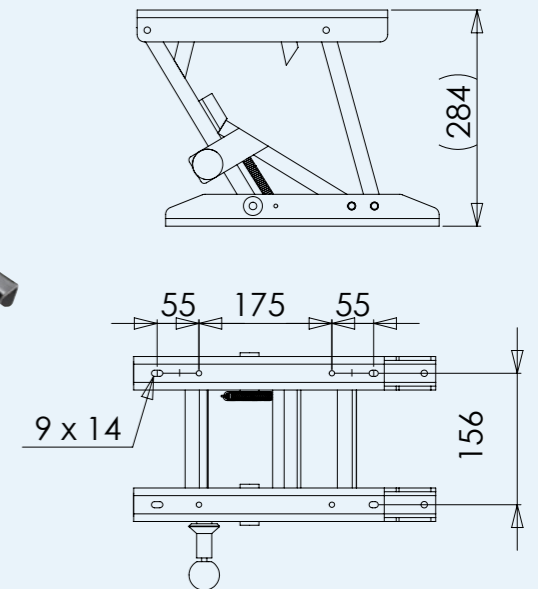

- Smartfold seatleg has been tested for all seats up to a weight of 26 KG
- M1 tested and approved by RDW (Test report RDW-76/115-0715)
- Provides a more easy entrance with chairs placed at the door of the vehicle
- Easy to operate by pulling out a pin
- Color: black

- 200403675 Folding mechanism Ford Transit Custom

- Easy to handle with unlock button and foot pedal
- Seat and seat leg are fixed by screws



Smartfloor introduces a lightweight leg for direct attachment in the airline rails of our Smartfloor. Using the Smartfloor lockable, the leg is easy to lock and unlock. There are 3 versions of the V-Leg that are available in different heights:

- Sliding V-leg, where the leg can be slid into the airline rails from front to back;
- Sliding/Rotating V-leg with the added advantage that the seat on the leg can be rotated 360 degrees;
- Tip&Fold Sliding V-leg, specific for the Smartseat Tip & Fold.

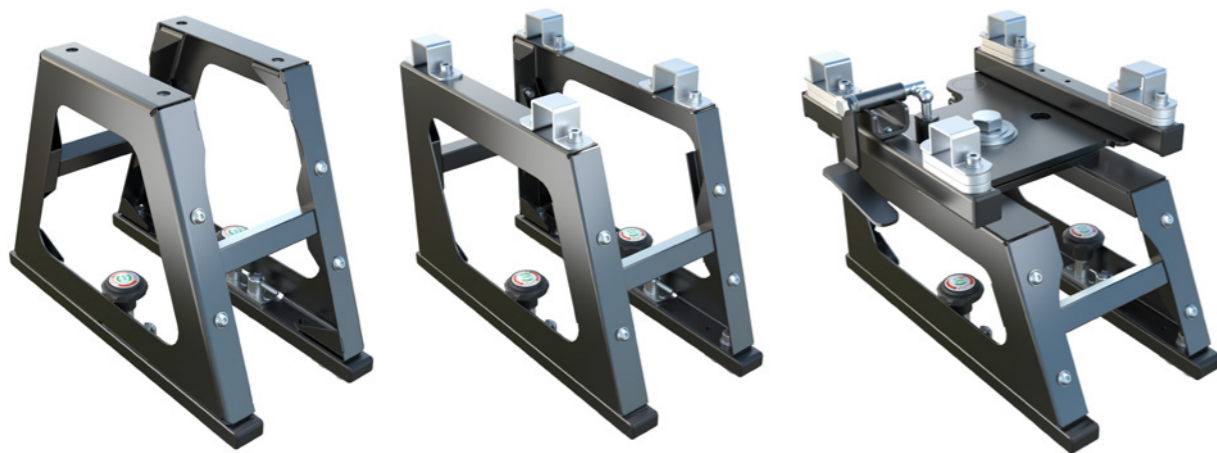

Item Code	Item name
10024824	Sliding Rotating V-leg 230-156
10024825	Sliding Rotating V-leg 230-173
10024826	Sliding Rotating V-leg 260-156
10024827	Sliding Rotating V-leg 260-173
10024820	Sliding V-leg 290-156
10024821	Sliding V-leg 290-173
10024822	Sliding V-leg 320-156
10024823	Sliding V-leg 320-173
10024828	Tip&Fold V-leg 290-156
10024829	Tip&Fold V-leg 320-156

Swivel platforms for driver and passenger seat

The Smart Swivel is now available! A lightweight swivel platform for both the driver and passenger seat. The product has been fully tested according to ECE requirements for M1 and N1 vehicles. The lightweight swivel platform, made of high-grade steel, provides a high degree of rigidity and balance while driving. The sliding mechanism used in our swivel platforms allows the user to easily rotate the seat.

The Smart Swivels are available for many vehicle types such as: Mercedes Sprinter, Fiat Ducato, Ford Transit, Mercedes Vito, Ford Custom, Volkswagen Crafter, Renault Trafic and others. For some models, a so-called handbrake kit is required so that the handbrake does not interfere when turning the seat.

The facts:

- Fully tested according to ECE requirements for M1 and N1 vehicles
- RDW approval
- Available for many vehicle types

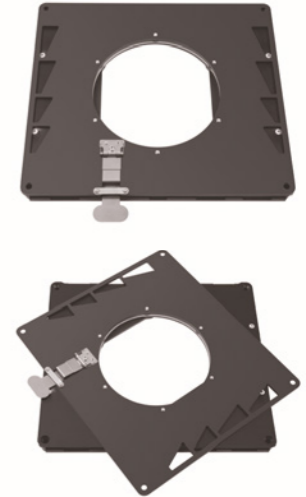

Item Code	item Name	Vehicle
10025834	Driver seat Smart Swivel 2.0	MB Sprinter 906 VW Crafter 2E
10025835	Co-Driver seat Smart Swivel 2.0	MB Sprinter 906 VW Crafter 2E
10025836	Driver seat Smart Swivel 2.0	MB Sprinter 907 910 Vito W447
10025837	Co-Driver seat Smart Swivel 2.0	MB Sprinter 907 910 Vito W447
10025838	Driver seat Smart Swivel 2.0	Ducato III Boxer II Jumper II Movano C
10025839	Co-Driver seat Smart Swivel 2.0	Ducato III Boxer II Jumper II Movano C
10025840	Driver seat Smart Swivel 2.0	Ford Custom V362 Ford Transit V363
10025841	Co-Driver seat Smart Swivel 2.0	Ford Custom V362 Ford Transit V363
10025842	Driver seat Smart Swivel 2.0	VW Crafter SY/SZ MAN TGE
10025843	Co-Driver seat Smart Swivel 2.0	VW Crafter SY/SZ MAN TGE
10025844	Driver seat Smart Swivel 2.0	Traffic III Vivaro B Talento Primastar
10025845	Co-Driver seat Smart Swivel 2.0	Traffic III Vivaro B Talento Primastar
10025846	Driver seat Smart Swivel 2.0	VW T5 T6 T6.1
10025847	Co-Driver seat Smart Swivel 2.0	VW T5 T6 T6.1
10025848	Driver seat Smart Swivel 2.0	Vivaro C Jumpy Expert Scudo ProAce
10025849	Co-Driver seat Smart Swivel 2.0	Vivaro C Jumpy Expert Scudo ProAce
10025850	Driver seat Smart Swivel 2.0	Maxus Deliver9 eDeliver9
10025851	Co-Driver seat Smart Swivel 2.0	Maxus Deliver9 eDeliver9

Type Code	From	Handbrake kit / height adapter
Sprinter: W 906 Crafter: 2E	Sprinter: 2006 - 2018 Crafter: 2006 - 2016	10025010
Sprinter: W 906 Crafter: 2E	Sprinter: 2006 - 2018 Crafter: 2006 - 2016	-
Sprinter: BR 907 910 Vito/V-Klasse: W447	Sprinter: 2018 - current Vito/V-Klasse: 2014 - current	10025010
Sprinter: BR 907 910 Vito/V-Klasse: W447	Sprinter: 2018 - current Vito/V-Klasse: 2014 - current	-
Type 250	2006 - current	-
Type 250	2006 - current	-
Custom: V362 Transit: V363	Custom: 2012 - 2023 Transit: 2014 - current	10025516
Custom: V362 Transit: V363	Custom: 2012 - 2023 Transit: 2014 - current	-
Crafter: SY/SZ TGE:	Crafter: 2016 - current TGE: 2016 - current	-
Crafter: SY/SZ TGE:	Crafter: 2016 - current TGE: 2016 - current	-
Traffic: FG/JG Primastar: X82 Vivaro B: X82 Talento: 296	Traffic: 2014 - current Primastar: 2016 - current	10025518
Traffic: FG/JG Primastar: X82 Vivaro B: X82 Talento: 296	Traffic: 2014 - current Primastar: 2016 - current Vivaro B: 2014 - 2019 Talento: 2016 - 2021	-
-	2003 - current	10025517
-	2003 - current	-
KO	Vivaro C: 2019 - current	-
KO	Vivaro C: 2019 - current	-
-	2020 - current	-
-	2020 - current	-

The Smartseat Easy M1 is designed for maximum passenger comfort and maximum commercial flexibility.

- Fixed or reclining backrest
- Integral 3-point seat belt
- Available in left-hand and right-hand models
- M1 tested and approved by RDW, according to the newest regulation UN/ECE R14, R16, R17, FMVSS/CMVSS 207, 210
- Optional armrest
- Various upholstery options available (including leather)
- Equipped with quick-release Smartleg supports
- Easy to clean

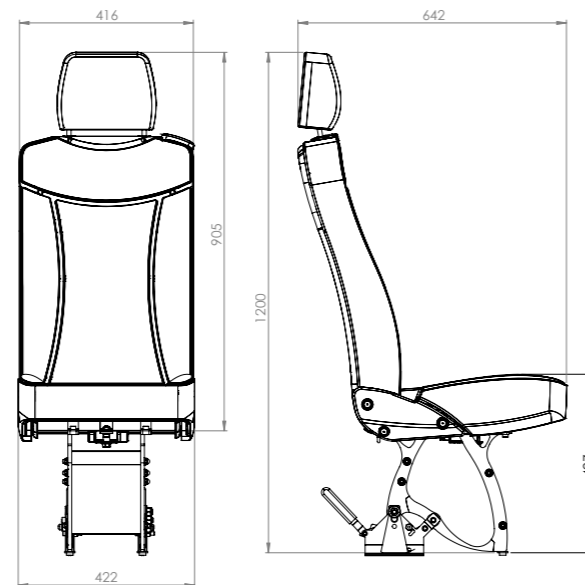

Item Code	Item name	Shoulder belt
10023317	Smartseat Easy MB Maturin	left
10023318	Smartseat Easy MB Maturin	right
10020948	Smartseat Easy Black artificial leather	left
10020949	Smartseat Easy Black artificial leather	right
10018987	Smartseat Easy Grey artificial leather	left
10018988	Smartseat Easy Grey artificial leather	right
10018989	Smartseat Easy Carmat Code	left
10018990	Smartseat Easy Carmat Code	right
10023319	Smartseat Easy MB Maturin	reclining left
10023320	Smartseat Easy MB Maturin	reclining right
10022305	Smartseat Easy Black artificial leather	reclining left
10022306	Smartseat Easy Black artificial leather	reclining right
10018996	Smartseat Easy Grey artificial leather	reclining left
10018997	Smartseat Easy Grey artificial leather	reclining right
10018998	Smartseat Easy Carmat Code	reclining left
10018999	Smartseat Easy Carmat Code	reclining right

Options		
10019046	Armrest for Smartseat, non-fitted	left
10019047	Armrest for Smartseat, non-fitted	right
10019048	Grab handle rear for Smartseat, non-fitted	
10019049	Grab handle side (black), preassembled	
10019050	Grab handle side (yellow), preassembled	

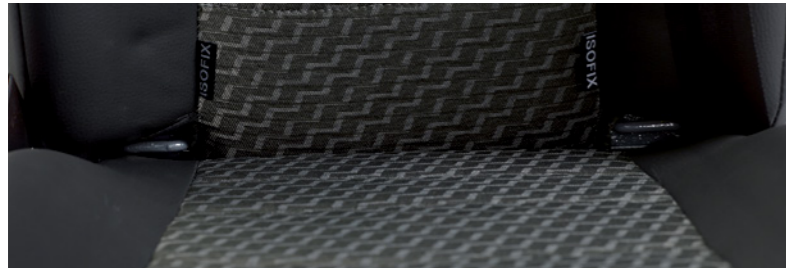

Item Code	Item name		Shoulder belt
10023323	Smartseat Easy MB Maturin	reclining ISOfix	left
10023324	Smartseat Easy MB Maturin	reclining ISOfix	right
10023571	Smartseat Easy Black artificial leather	reclining ISOfix	left
10023572	Smartseat Easy Black artificial leather	reclining ISOfix	right
10019016	Smartseat Easy Grey artificial leather	reclining ISOfix	left
10019017	Smartseat Easy Grey artificial leather	reclining ISOfix	right
10019018	Smartseat Easy Carmat Code	reclining ISOfix	left
10019019	Smartseat Easy Carmat Code	reclining ISOfix	right

Options			
10019046	Armrest for Smartseat, non-fitted		left
10019047	Armrest for Smartseat, non-fitted		right
10019048	Grab handle rear for Smartseat, non-fitted		
10019049	Grab handle side (black), preassembled		
10019050	Grab handle side (yellow), preassembled		

Foldable Smartseat Tip & Fold M1 seat with maximum comfort and minimum use of space when folded.

- Extremely small thickness when seat is folded
- Maximum resting possibility
- Very small height from the cushion edge including the entire rotator
- Seat cushion remains blocked after passenger leaves.
- M1 tested and approved by RDW, according to the newest regulation UN/ECE R14, R16, R17, FMVSS/CMVSS 207, 210
- Fully integrated controls and safety belts to avoid injury
- Easy to clean
- Standard with armrest
- Reclining Backrest



Item Code	Item name	Shoulder belt
10023325	Smartseat Tip & Fold MB Maturin	left
10023326	Smartseat Tip & Fold MB Maturin	right
10022303	Smartseat Tip & Fold Black artificial leather	left
10022304	Smartseat Tip & Fold Black artificial leather	right
10019032	Smartseat Tip & Fold Grey artificial leather	left
10019033	Smartseat Tip & Fold Grey artificial leather	right
10019034	Smartseat Tip & Fold Carmat Code	left
10019035	Smartseat Tip & Fold Carmat Code	right
10023327	Smartseat Tip & Fold MB Maturin	ISOfix left
10023328	Smartseat Tip & Fold MB Maturin	ISOfix right
10023705	Smartseat Tip & Fold Black artificial leather	ISOfix left
10023706	Smartseat Tip & Fold Black artificial leather	ISOfix right
10019042	Smartseat Tip & Fold Grey artificial leather	ISOfix left
10019043	Smartseat Tip & Fold Grey artificial leather	ISOfix right
10019044	Smartseat Tip & Fold Carmat Code	ISOfix left
10019045	Smartseat Tip & Fold Carmat Code	ISOfix right

Item Code	Item name
10020754	Single seatleg 270 mm Tip & Fold M1
10020967	Single seatleg 320 mm Tip & Fold M1
10019152	Single seatleg 350 mm Tip & Fold M1
10019153 Sprinter	Single wheel arch frame 280 mm L/R
10019154 Transit / MAN / Crafter	Single wheel arch frame 329 mm L/R
10019155 Master / Movano	Single wheel arch frame 370 mm 105 L/R
10019156 Boxer / Jumper / Ducato	Single wheel arch frame 370 mm 125 L/R
10019157 Sprinter	Double wheel arch frame 280 mm left
10019158 Sprinter	Double wheel arch frame 280 mm right
10019159 Crafter / Transit / MAN	Double wheel arch frame 329 mm left
10019160 Crafter / Transit / MAN	Double wheel arch frame 329 mm right
10020760	Armrest left, preassembled
10020761	Armrest right, preassembled

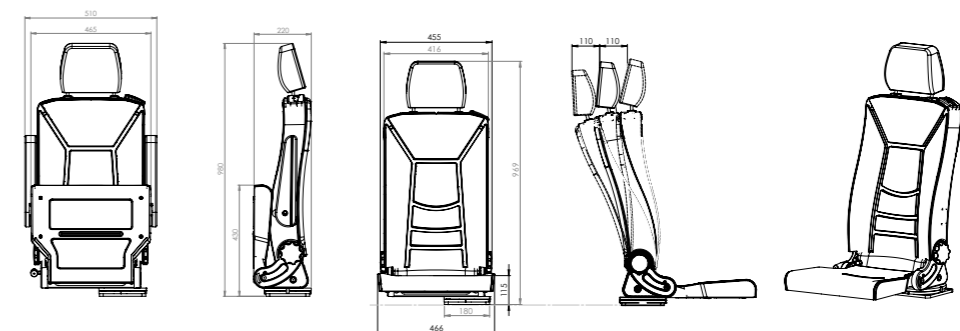

Folding Smartseat Flip-Up M1 seat with maximum comfort and minimum use of space when folded.

- Slim design thickness when seat is folded
- Seat cushion remains locked after passenger leaves.
- M1 tested and approved by RDW, according to the newest regulation UN/ECE R14, R16, R17, FMVSS/CMVSS 207, 210
- Easy to clean



Item Code	Item name	Shoulder belt
10023329	Smartseat Flip-up MB Maturin	left
10023330	Smartseat Flip-up MB Maturin	right
10022360	Smartseat Flip-Up Black artificial leather	left
10022361	Smartseat Flip-Up Black artificial leather	right
10020789	Smartseat Flip-Up Grey artificial leather	left
10020790	Smartseat Flip-Up Grey artificial leather	right
10020791	Smartseat Flip-Up Carmat Code	left
10020792	Smartseat Flip-Up Carmat Code	right
10023335	Smartseat Flip-up MB Maturin	reclining ISOfix left
10023336	Smartseat Flip-up MB Maturin	reclining ISOfix right
10023709	Smartseat Flip-Up Black artificial leather	reclining ISOfix left
10023710	Smartseat Flip-Up Black artificial leather	reclining ISOfix right
10020852	Smartseat Flip-Up Grey artificial leather	reclining ISOfix left
10020853	Smartseat Flip-Up Grey artificial leather	reclining ISOfix right
10020854	Smartseat Flip-Up Carmat Code	reclining ISOfix left
10020855	Smartseat Flip-Up Carmat Code	reclining ISOfix right

Item Code	Item name
10020931	Seat leg 270 mm for Smartseat Flip-Up
10020968	Seat leg 320 mm for Smartseat Flip-Up
10020932	Seat leg 350 mm for Smartseat Flip-Up
20001550	Single seat lowleg 100 mm Flip-up



The Smartseat Easy M1 XL is designed for maximum passenger comfort and maximum commercial flexibility.

- Fixed or reclining backrest
- Integral 3-point seat belt
- Available in left-hand belt and right-hand belt models
- M1 tested and approved by RDW, according to the newest regulation UN/ECE R14, R16, R17, FMVSS/CMVSS 207, 210
- Optional armrest
- Various upholstery options available (including leather)
- Equipped with quick-release Smartleg supports
- Easy to clean
- ABS back panel

Optional

- Extra Foam seatcushion
- Seatcushion heating
- Piping
- Upholstered armrest

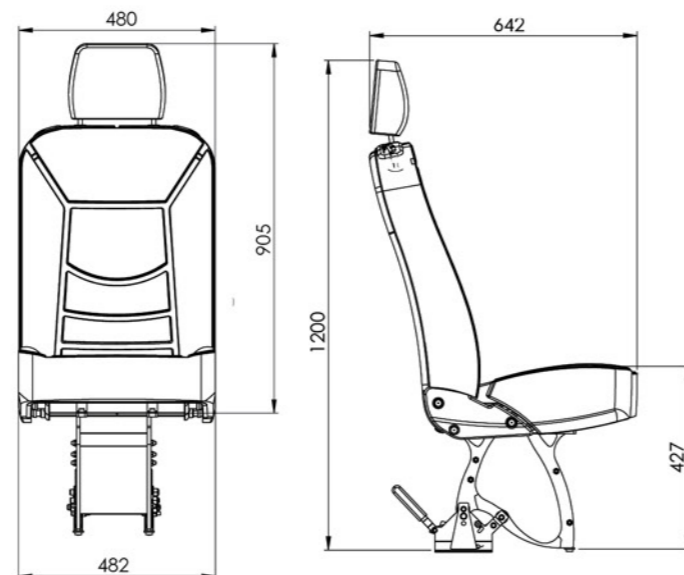

Item Code	Item name		Shoulder belt
10023343	Smartseat Easy XL MB Maturin	reclining ISOfix	left
10023344	Smartseat Easy XL MB Maturin	reclining ISOfix	right
10023457	Smartseat Easy XL Black artificial leather	reclining ISOfix	left
10023458	Smartseat Easy XL Black artificial leather	reclining ISOfix	right
10020884	Smartseat Easy XL Grey artificial leather	reclining ISOfix	left
10020885	Smartseat Easy XL Grey artificial leather	reclining ISOfix	right
10020886	Smartseat Easy XL Carmat Code	reclining ISOfix	left
10020887	Smartseat Easy XL Carmat Code	reclining ISOfix	right



The Smartseat RV M1 offers a maximum of space in the entrance area.

- Fully foldable backrest
- Integral 3-point seat belt
- Available in left-hand belt and right-hand belt models
- Height-adjustable headrest
- Various upholstery options available (including artificial leather)
- Easy to clean
- Optional: Armrest
- Optional: with ISOFIX



Item Code	Item name		Shoulder belt
10023345	Smartseat RV MB Maturin	reclining to the front	left
10022620	Smartseat RV Black artificial leather	reclining to the front	left
10022618	Smartseat RV Grey artificial leather	reclining to the front	left
10022622	Smartseat RV Carmat Code	reclining to the front	left

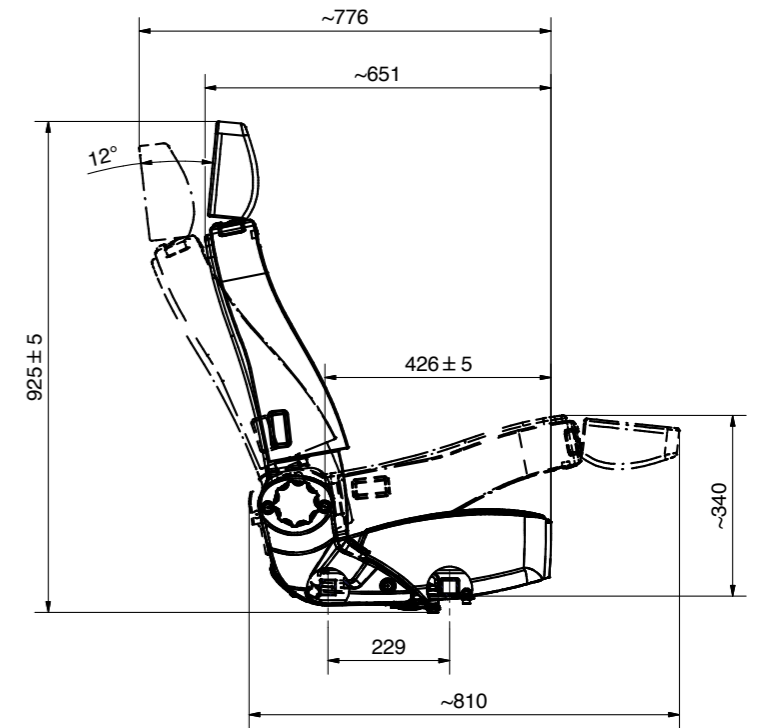
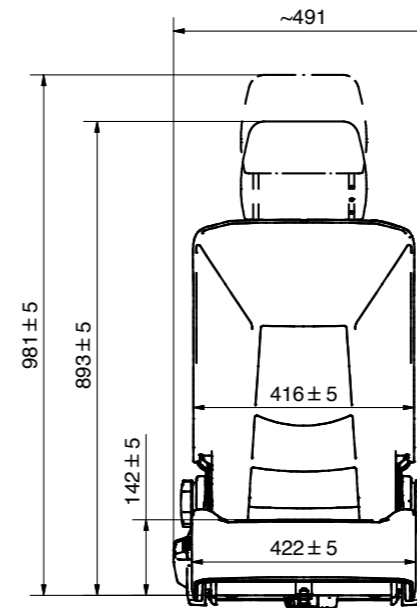



Smartseat
Travel M2

The Smartseat Travel M2 and Smartseat Travel Luxury M2 are designed for maximum passenger comfort.

- Fixed or adjustable backrest
- Integral 3-point seatbelts
- Available in left-hand and right-hand models
- Alongside movable system
- M2 tested and approved by RDW, according to the newest regulation UN/ECE R14
- Various upholstery options available (including leather)
- Equipped with quick-release Smartleg supports

Available in:

- Double seat
- Single seat

Optional:

- Armrest
- Grab handles
- Foot support
- Yellow /black hand grabs
- Folding table
- Magazine net
- Yellow /black hand grabs

Please contact Smartfloor for more information and all possibilities.



Smartseat
Travel Luxury M2

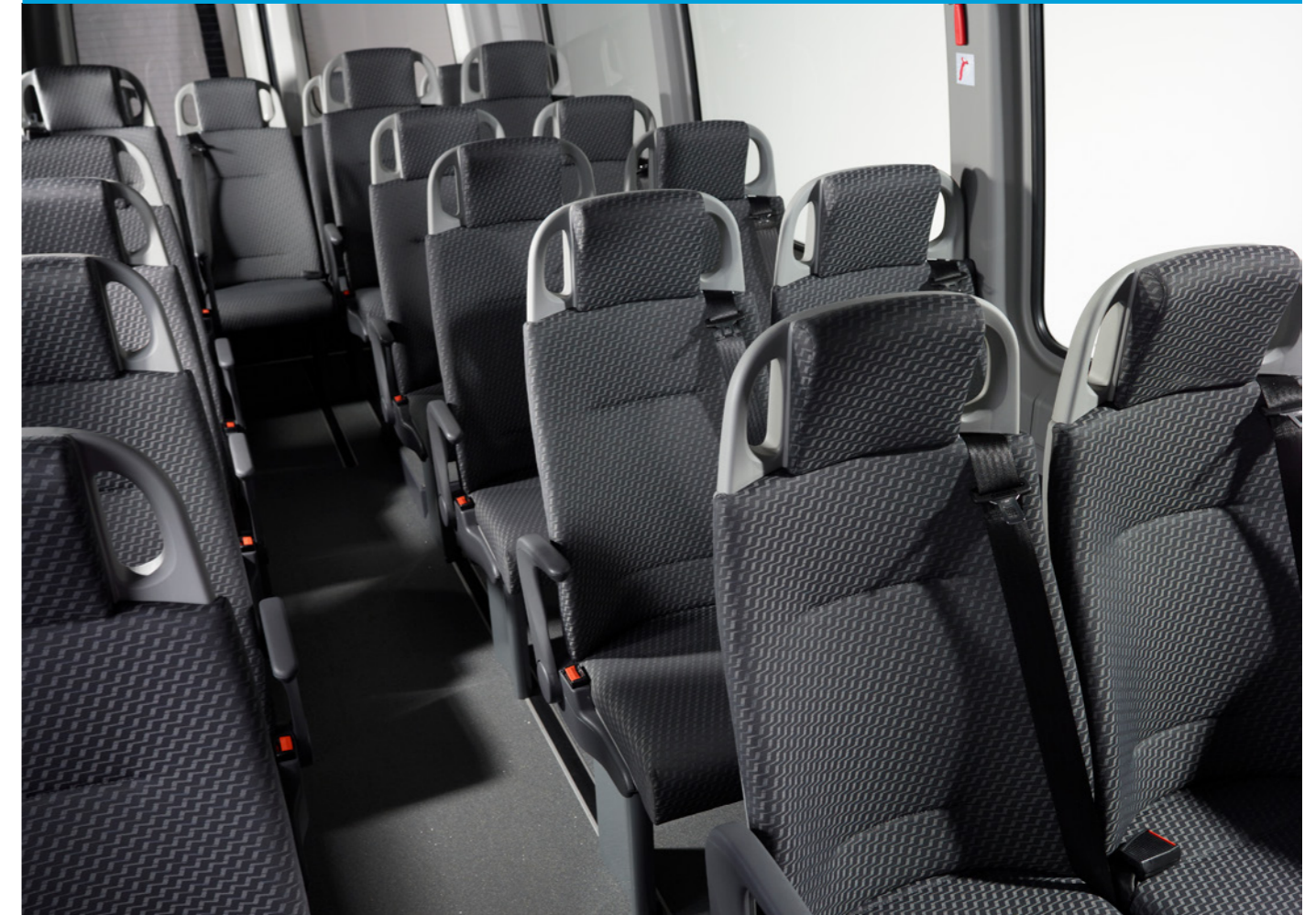





PROTEKTOR OCCUPANT & WHEELCHAIR RESTRAINT SYSTEM DESIGNED ACCORDING TO DIN 75078 and ISO 10542.

In the 1970s, AMF-Bruns was the first manufacturer in the world to develop a retractor 4-point securement system. Other suppliers followed this example only 20 years later. In the meantime, the AMF-Bruns PROTEKTOR system has become the international standard for securing wheelchairs and their occupants in vehicles.

AMF-Bruns continuous product improvement is reflected in the latest innovation from the inventor of the 4-point wheelchair restraint system. The new PROTEKTOR 2.0 retractors are now even easier to operate, less weight and optimum force distribution in the system in the event of a crash.

With PROTEKTOR 2.0, AMF-Bruns once again sets high standards in terms of safety, design and functionality. No other system secures a wheelchair in a vehicle more dependably than the new PROTEKTOR 2.0 wheelchair restraint system!

The PROTEKTOR 2.0 retractors have an ergonomic profile and an impressive aesthetic design. The compact design reduces weight and is a space saving solution. Thanks to the design, even large wheelchairs can be secured in a small space. The red lever accentuates the release button and contributes to the state-of-the-art design of the retractor. For its intuitive use, ergonomic, function, and design concept, the PROTEKTOR 2.0 system received the RED DOT DESIGN AWARD 2020.

In parallel with this development, AMF-Bruns has always constantly tested the PROTEKTOR system according to worldwide standards since the 1970s.

In all tests, the safety results of the PROTEKTOR system always exceeded the required safety standards. Even in the case of heavy electric wheelchairs, the PROTEKTOR system provides more safety than any other system. Dynamic crash tests at a speed of 31 mph and a deceleration of 20 G, numerous static test series, as well as practical driving tests with wheelchairs and anthropomorphic test devices prove this repeatedly.

AMF-Bruns' high standards are complemented by dedicated work in national and international standards

committees. Close cooperation with institutions including TÜV, the Federal Highway Research Institute (BASt), the Dynamic Test Center (Switzerland) and the Union Technique de l'Automobile, du Motorcycle et du Cycle (France) ensures constant improvement and control of the PROTEKTOR system.

SAFE DIVERSITY: The floor anchorage offers L-Track Fitting and Smart Fitting. The wheelchair fastening can be connected via J-hook, carabiner or loop. The AMF-Bruns PROTEKTOR system is even easier, faster and safer to use than any other system on the market. It is compatible with all wheelchairs and vehicles and is ideal for use with wheelchairs with an integrated lap belt.

INTERNATIONAL STANDARDS

- ISO 10542-1
- DIN 75078-2
- RESNA WC18 (PlatinumSeries)
- CSA Z605
- FMVSS/CMVSS
- AS 2596
- SAE J2249
- 2001/85/EC
- ADA



reddot award
product design 2020



BLACKSERIES

The BlackSeries is tested according to ISO 10542 and is the lightweight amongst the retractor systems. It features a robust, black ABS housing and an easy-to-use semi-automatic pull-out.



PROTEKTOR-System

BLACKSERIES

General note!
Static belts are only permitted for front attachment.

RETRACTOR SYSTEM WITH LOOP

4 STUD FITTING, FLEXIBLE



Protektor®-System
Pro 2 B LV with loop
and 4 stud fitting, flexible

- 2 x retractor belt LV
- 2 x static belt LV
- 1 x pelvis belt

Item-No. H 450 502 LV

4 STUD FITTING, FLEXIBLE



Protektor®-System
Pro 4 B LV with loop
and 4 stud fitting, flexible

- 4 x retractor belt LV
- 1 x pelvis belt

Item-No. H 450 504 LV

MONO FITTING



Protektor®-System
Pro 2 B LM with loop and Mono
fitting

- 2 x retractor belt LM
- 2 x static belt LM
- 1 x pelvis belt

Item-No. H 450 502 LM

MONO FITTING



Protektor®-System
Pro 4 B LM with loop and
Mono fitting

- 4 x retractor belt LM
- 1 x pelvis belt

Item-No. H 450 504 LM

RETRACTOR SYSTEM WITH HOOK

4 STUD FITTING, FLEXIBLE



Protektor®-System
Pro 2 B HV with hook and
4 stud fitting, flexible

- 2 x retractor belt HV
- 2 x static belt HV
- 1 x pelvis belt

Item-No. H 450 522 HV

4 STUD FITTING, FLEXIBLE



Protektor®-System
Pro 4 B HV with hook and
4 stud fitting, flexible

- 4 x retractor belt HV
- 1 x pelvis belt

Item-No. H 450 524 HV

MONO FITTING



Protektor®-System
Pro 2 B HM with hook and
Mono fitting

- 2 x retractor belt HM
- 2 x static belt HM
- 1 x pelvis belt

Item-No. H 450 522 HM

MONO FITTING



Protektor®-System
Pro 4 B HM with hook
and Mono fitting

- 4 x retractor belt HM
- 1 x pelvis belt

Item-No. H 450 524 HM

RETRACTOR SYSTEM WITH CARABINER

4 STUD FITTING, FLEXIBLE



Protector®-System
Pro 2 B CV with carabiner
and 4 stud fitting, flexible

- 2 x retractor belt CV
- 2 x static belt CV
- 1 x pelvis belt

Item-No. H 450 552 CV

4 STUD FITTING, FLEXIBLE



Protector®-System
Pro 4 B CV with carabiner
and 4 stud fitting, flexible

- 4 x retractor belt CV
- 1 x pelvis belt

Item-No. H 450 554 CV

MONO FITTING



Protector®-System
Pro 2 B CM with carabiner
and Mono fitting

- 2 x retractor belt CM
- 2 x static belt CM
- 1 x pelvis belt

Item-No. H 450 552 CM

MONO FITTING



Protector®-System
Pro 4 B CM with carabiner
and Mono fitting

- 4 x retractor belt CM
- 1 x pelvis belt

Item-No. H 450 554 CM

RETRACTOR WITH LOOP



Retractor B LV
with loop and
4 stud fitting,
flexible

Item-No.
H 450 509 LV



Retractor B LM
with loop and
Mono fitting

Item-No.
H 450 509 LM

RETRACTOR WITH HOOK



Retractor B HV
with hook and
4 stud fitting, flexible

Item-No.
H 450 534 HV



Retractor B HM
with hook and
Mono fitting

Item-No.
H 450 534 HM

RETRACTOR WITH CARABINER



Retractor B CV
with carabiner and
4 stud fitting, flexible

Item-No.
H 450 564 CV



Retractor B CM
with carabiner and
Mono fitting

Item-No.
H 450 564 CM



SILVERSERIES

The ISO 10542 tested SilverSeries has an automatic pull-out.
The high-quality zinc die-cast housing is particularly robust
and suitable for daily use in the vehicle.



PROTEKTOR-System

SILVERSERIES

WHEELCHAIR RESTRAINT SYSTEM

General note!
Static belts are only permitted for front attachment.

RETRACTOR SYSTEM WITH LOOP

4 STUD FITTING, FLEXIBLE



Protektor®-System
Pro 2 S LV with loop
and 4 stud fitting , flexible

- 2 x retractor belt LV
- 2 x static belt LV
- 1 x pelvis belt

Item-No. H 450 501 LV

4 STUD FITTING, FLEXIBLE



Protektor®-System
Pro 4 S LV with loop
and 4 stud fitting, flexible

- 4 x retractor belt LV
- 1 x pelvis belt

Item-No. H 450 503 LV

MONO FITTING



Protektor®-System
Pro 2 S LM with loop
and Mono fitting

- 2 x retractor belt LM
- 2 x static belt LM
- 1 x pelvis belt

Item-No. H 450 501 LM

MONO FITTING



Protektor®-System
Pro 4 S LM with loop
and Mono fitting

- 4 x retractor belt LM
- 1 x pelvis belt

Item-No. H 450 503 LM

RETRACTOR SYSTEM WITH HOOK

4 STUD FITTING, FLEXIBLE



Protektor®-System
Pro 2 S HV with hook
and 4 stud fitting, flexible

- 2 x retractor belt HV
- 2 x static belt HV
- 1 x pelvis belt

Item-No. H 450 520 HV

4 STUD FITTING, FLEXIBLE



Protektor®-System
Pro 4 S HV with hook
and 4 stud fitting, flexible

- 4 x retractor belt HV
- 1 x pelvis belt

Item-No. H 450 525 HV

MONO FITTING



Protektor®-System
Pro 2 S HM with hook
and Mono fitting

- 2 x retractor belt HM
- 2 x static belt HM
- 1 x pelvis belt

Item-No. H 450 520 HM

MONO FITTING



Protektor®-System
Pro 4 S HM with hook
and Mono fitting

- 4 x retractor belt HM
- 1 x pelvis belt

Item-No. H 450 525 HM

RETRACTOR SYSTEM WITH CARABINER

4 STUD FITTING, FLEXIBLE



Protektor®-System
Pro 2 S CV with carabiner
and 4 stud fitting, flexible

- 2 x retractor belt CV
- 2 x static belt CV
- 1 x pelvis belt

Item-No. H 450 550 CV

4 STUD FITTING, FLEXIBLE



Protektor®-System
Pro 4 S CV with carabiner
and 4 stud fitting, flexible

- 4 x retractor belt CV
- 1 x pelvis belt

Item-No. H 450 555 CV

MONO FITTING



Protektor®-System
Pro 2 S CM with carabiner
and Mono fitting

- 2 x retractor belt CM
- 2 x static belt CM
- 1 x pelvis belt

Item-No. H 450 550 CM

MONO FITTING



Protektor®-System
Pro 4 CM with carabiner
and Mono fitting

- 4 x retractor belt CM
- 1 x pelvis belt

Item-No. H 450 555 CM

RETRACTOR WITH LOOP



Retractor S LV
with loop and
4 stud fitting, flexible

Item-No.
H 450 505 LV



Retractor S LM
with loop
and Mono fitting

Item-No.
H 450 505 LM

RETRACTOR WITH HOOK



Retractor S HV
with hook and
4 stud fitting, flexible

Item-No.
H 450 530 HV



Retractor S HM
with hook
and Mono fitting

Item-No.
H 450 530 HM

RETRACTOR WITH CARABINER



Retractor S CV
with carabiner and
4 stud fitting, flexible

Item-No.
H 450 560 CV



Retractor S CM
with carabiner
and Mono fitting

Item-No.
H 450 560 CM



PLATINUMSERIES HEAVY DUTY HD160





Wheelchair Restraint System

Weight increases due to electric wheelchairs and wheelchair users require a wheelchair restraint system that can withstand higher loads. AMF-Bruns developed the new PROTEKTOR PlatinumSeries after intensive crash tests indicated the need for more durable and robust retractors. The PlatinumSeries is a heavyduty 4-point securement system for wheelchairs and their occupants, suitable for a total weight of up to 160 kg – creating a new level of safety!



- 4-point securement system for use up to a total weight of 160 kg
- Robust construction and compact design
- Simple application and easy operation
- PlatinumSeries is compatible with all wheelchairs and vehicles
- Complies with ISO 10542, WC18 and DIN 75078-2 with integrated lap belt
- Ensures a safe connection between wheelchair and vehicle, even if the wheelchair deforms in an accident

Protektor PlatinumSeries HD 160 Black

WHEELCHAIR RESTRAINT SYSTEM

RETRACTOR SYSTEM WITH LOOP

4 STUD FITTING, FLEXIBLE



Heavy Duty Protektor®-System Pro 4 PB LV with loop and 4 stud fitting, flexible

- 4 x retractor belt LV
- 1 x pelvis belt

Item no. H 450 804 LV

RETRACTOR SYSTEM WITH HOOK

4 STUD FITTING, FLEXIBLE



Heavy Duty Protektor®-System Pro 4 PB HV with hook and 4 stud fitting, flexible

- 4 x retractor belt HV
- 1 x pelvis belt

Item no. H 450 824 HV

RETRACTOR SYSTEM WITH CARABINER

4 STUD FITTING, FLEXIBLE



Heavy Duty Protektor®-System Pro 4 PB CV with carabiner and 4 stud fitting, flexible

- 4x retractor belt CV
- 1x pelvis belt

Item-No. H 450 854 CV

RETRACTOR WITH LOOP



Heavy Duty Retraktor PB LV with loop and 4 stud fitting, flexible

Item no. H 450 809 LV



Heavy Duty Retraktor PB LM with loop and monofitting

Item no. H 450 809 LM

RETRACTOR WITH HOOK



Heavy Duty Retraktor PB HV with hook and 4 stud fitting, flexible

Item-No. H 450 834 HV



Heavy Duty Retraktor PB HM with loop and monofitting

Item-No. H 450 834 HM

RETRACTOR WITH CARABINER



Heavy Duty Retraktor PB CV with carabiner and 4 stud fitting, flexible

Item-No. H 450 864 CV



Heavy Duty Retraktor PB CM with carabiner and monofitting

Item-No. H 450 864 CM

Protektor PlatinumSeries HD 160 Silver

WHEELCHAIR RESTRAINT SYSTEM

RETRACTOR SYSTEM WITH CARABINER



Heavy Duty Protektor®-System Pro 4 PS CV with carabiner and 4 stud fitting, flexible

- 4 x retractor belt CV
- 1 x pelvis belt

Item no. H 450 855 CV

RETRACTOR WITH LOOP



Heavy Duty Retraktor PS LV with loop and 4 stud fitting, flexible

Item-No. H 450 805 LV



Heavy Duty Retraktor PS LM with loop and monofitting

Item no. H 450 805 LM

RETRACTOR WITH HOOK



Heavy Duty Retraktor PS HV with hook and 4 stud fitting, flexible

Item no. H 450 830 HV



Heavy Duty Retraktor PS HM with loop and monofitting

Item no. H 450 830 HM

RETRACTOR WITH CARABINER



Heavy Duty Retraktor PS CV with carabiner and 4 stud fitting, flexible

Item-No. H 450 860 CV



Heavy Duty Retraktor PS CM with carabiner and monofitting

Item-No. H 450 860 CM

STATIC BELTS



Static belt LV
with loop
and 4 stud fitting
(front attachment)

Item-No.
H 450 510 LV

STATIC BELT WITH 4 STUD FITTING



Static belt HV
with hook
and 4 stud fitting
(front attachment)

Item-No.
H 450 535 HV



Static belt CV
with carabiner
and 4 stud fitting
(front attachment)

Item-No.
H 450 565 CV

STATIC BELTS



Static belt LM
with loop
and Mono fitting
(front attachment)

Item-No.
H 450 510 LM

STATIC BELT WITH MONO FITTING



Static belt HM
with hook
and Mono fitting
(front attachment)

Item-No.
H 450 535 HM



Static belt CM
with carabiner
and Mono fitting
(front attachment)

Item-No.
H 450 565 CM

ELECTRIC BELTS



Electric belt L
with loop,
length 3,6 m
(front attachment)

Item-No.
H 450 240 L



Electric belt H
with hook,
length 3,6 m
(front attachment)

Item-No.
H 450 240 H

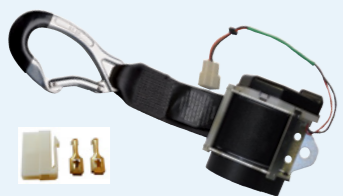

Electric belt C
with carabiner,
length 3,6 m
(front attachment)

Item-No.
H 450 240 C

Zinc high pressure die casting cover
for electric belt complete cover (front
attachment)

Item-No.
H 350 257

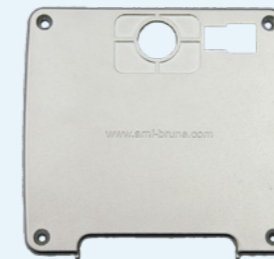



Occupant restraints

OCCUPANT RESTRAINT SYSTEM



Static shoulder belt with buckle, two part
Item-No. H 350 227



Pelvis belt
Standard length
Item-No. H 450 200
240 cm
XL Version
Item-No. H 450 198
320 cm



Automatic pelvis belt with flexible buckle
Item-No. H 350 205

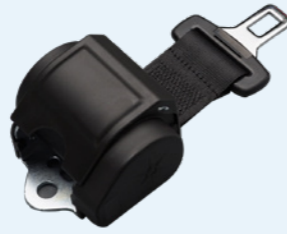

Automatic pelvis belt
Item-No. H 350 207



Flexible buckle length 300 mm
Item-No. H 350 210



Automatic shoulder belt without height adjustment
Item-No. H 450 225



Automatic shoulder belt (height adjustable)
Item-No. H 450 235



Automatic shoulder belt without height adjustment incl. two 4 stud fittings
Item-No. H 450 250



Automatic shoulder belt with height adjustment incl. two 4 stud fittings
Item-No. H 450 239



Static shoulder belt
Item-No. H 350 226

OCCUPANT RESTRAINT SYSTEM



Automatic 3 point shoulder belt with retractor height-adjustment
Item no. H 450 255



Automatic 3-Point-Belt with height adjustment incl. tongue
Item-No. H 450 231



Automatic 3 point belt without height adjustment
Item-No. H 350 230



Automatic 3-Point-Belt without height adjustment incl. two 4 stud fittings
Item-No. H 350 251



Automatic 3-Point-Belt with height adjustment incl. two 4 stud fittings
Item-No. H 450 252



WAV Automatic 3-Point-Belt with height adjustment and two flexible buckles, 300 mm
Item-No. H 350 233



WAV Automatic 3-Point-Belt without height adjustment and two flexible buckles, 300 mm
Item-No. H 350 232



Harness belt (only in combination with shoulder belt)
Item-No. H 450 222

ACCESSORIES

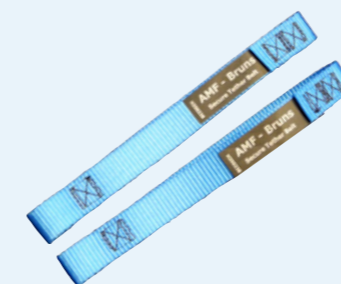

Secure belt 300 mm

Item-No. H 350 238

FLOOR SYSTEMS



Protektor® Surface track

- not predrilled
- | | |
|----------------|--------------------|
| 1000 mm length | Item-No. H 150 132 |
| 1500 mm length | Item-No. H 150 134 |
| 1750 mm length | Item-No. H 150 135 |
| 3000 mm length | Item-No. H 150 136 |
- predrilled
- | | |
|----------------|--------------------|
| 3000 mm length | Item-No. H 150 385 |
|----------------|--------------------|

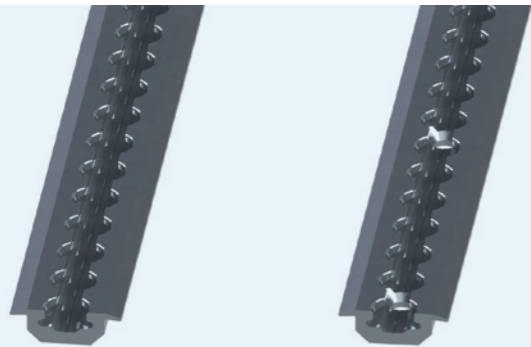

Protektor® Insert track

- not predrilled
- | | |
|----------------|--------------------|
| 1750 mm length | Item-No. H 150 120 |
| 3500 mm length | Item-No. H 150 130 |
- predrilled
- | | |
|----------------|--------------------|
| 3500 mm length | Item-No. H 150 375 |
|----------------|--------------------|



Floor pocket Chassis reinforcement kits available, please ask for details.

Item no. 200269390

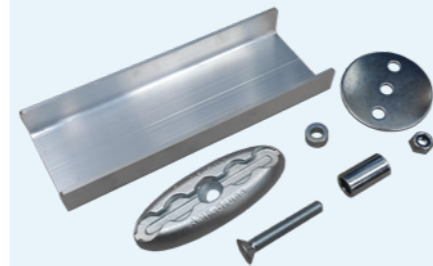

Floor pocket Back (incl. U-profile)

Item-No. 200309340

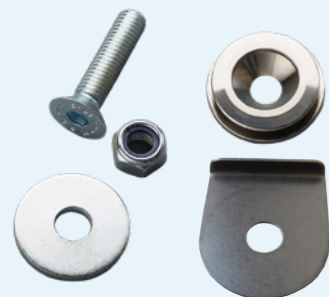

Monodisc (floor) Chassis reinforcement kits available, please ask for details.

Item-No. H 150 917 with Bolt M12 50 mm

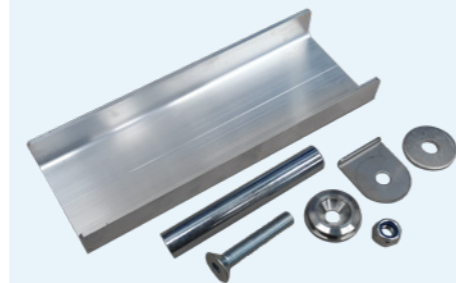

Mono disc Back (incl. U-profile)

Item-No. 200309251

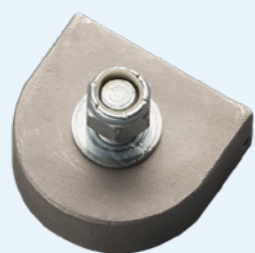

Mono fitting (head piece)

Item-No. H 150 916 with Bolt M12 50 mm

ACCESSORIES



4 stud fitting
with bolt

Item-No.
H 150 615



4 stud fitting

Item-No.
2002 11247

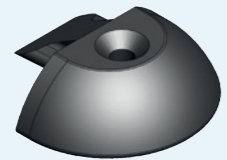

End cap for
surface track

Item-No.
200 261 878

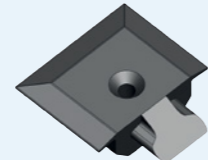
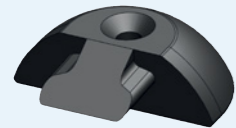

End cap for
insert track

Item-No.
200 261 840

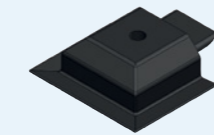

ACCESSORIES



Easy-Bag
for restraint system

Item-No.
10019363



Storage box
167.5 x 690 x 383.5 mm

Item-No.
10012744



Breast belt
180 cm length
160 cm length
110 cm length

Item-No. H 150 222
Item-No. H 150 223
Item-No. H 150 224



Storage box
180 x 840 x 480 mm

Item-No.
10012270



Black grab handle

Item-No.
10008015

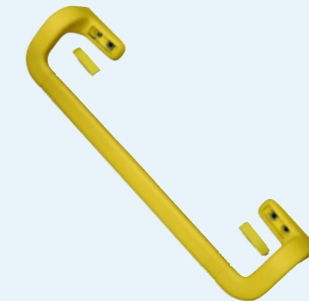

Yellow grab handle

Item-No.
10008016



Interior paneling back and
side loading door
VW Crafter/
MAN TGE

Item-No.
10023062



Rubber plugs
VW Crafter/
MAN TGE

Item-No.
(L2) 10023061
(L3) 10022913



Heating duct system
Ford Transit Custom

Item-No.
10019740

20001126
Luggagehook





Back and head support

Smartfloor includes two special back and head support constructions to provide the best possible protection of the back and head of a wheelchair occupant in the event of an accident during transport. Both constructions are suitable for mounting to the floor in an airline rail and flexible in their application at any desired location in the vehicle.

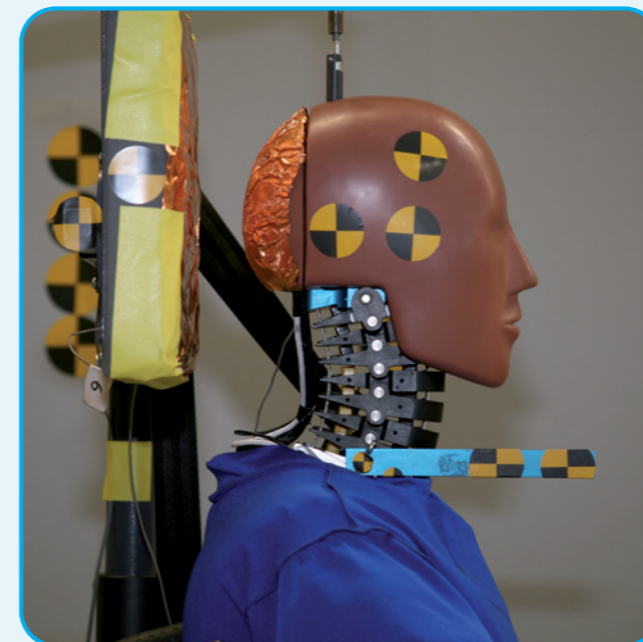

Fixed third belt point

Smartfloor delivers a special 3-point shoulder belt for vehicles that are fitted with an airline guide rail mounted in the top side of the vehicle. By means of this rail, a third belt point can be easily created throughout the interior of the vehicle. The advantage is that the vehicle, in combination with a Smartfloor, meets ISO 10542 standards. Delivery options include either a fixed belt or an auto-retractable belt.

Standard sets

Smartfloor supplies the AMF Protektor in standard sets inclusive of a red, static hip belt. Depending on the options selected, the sets are fitted with either 2 or 4 retractors, safety belt lock or stainless steel open hooks for attachment to the wheelchair. Options further include a static 3-point shoulder belt or a 3-point auto-retractable shoulder belt. For a complete list of all available sets, see the table on the next page.



EASYPULL
Winch & Front Restraint System

The fully integrated wheelchair restraint system acc. ISO 10542 and DIN 75078-2 Standards with automatic winch function. Compatible with EMC (electro magnetic compatibility) in accordance with the European legislation.



EASYPULL
Winch & Front Restraint System

Specification

- Easy operation
- Wireless remote control
- Audible signal when belt straps are securely locked
- 4 m belt length
- Easy installation
- Compact design
- 2 speed levels
- 20 G crash tested
- ISO 10542 tested
- Individually adjustable end position of the wheelchair inside the vehicle

TECHNICAL DATA

Load Capacity (SWL):	160 kg
Control:	via push buttons
Power:	electrical, 12 V
Installation:	retrofitable

ITEM CODE ITEM NAME

H450300L	EasyPull with Loop
H450300H	EasyPull with Hook

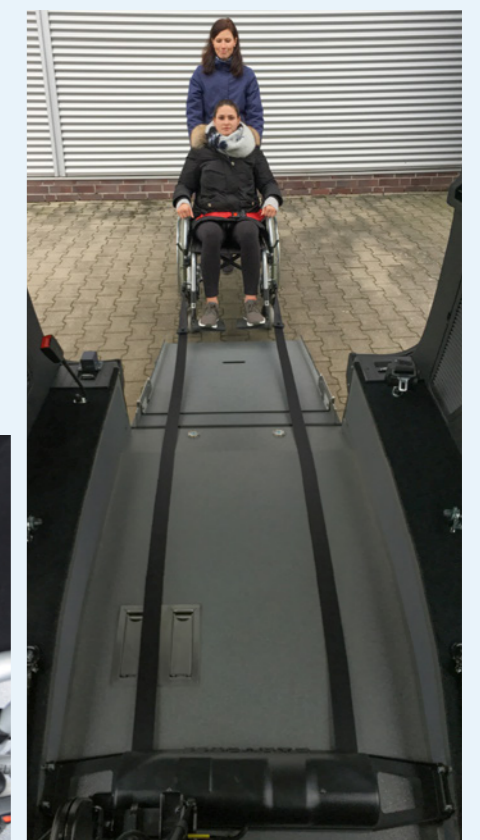

RAIL SOLUTION

VEHICLE APPROVED ANCHORAGE POINTS FOR OCCUPANT RESTRAINTS

According to EU directive 2007/46/EG (214/2014 Annex XI, 3) – mandatory in European countries

UPPER ANCHORAGE POINTS

All AMF-Bruns occupant restraint systems – whether static or automatic shoulder belts in combination with a separate pelvis belt or integrated 3 point belt – have been tested with 24.5 kN forwards and 8.2 kN backwards. AMF-Bruns has developed and produces special assembly kits for each vehicle. The pull tests are carried out in our own test centre in cooperation with TÜV.

The assembly kits are compatible with all AMF-Bruns restraint systems.

AMF-BRUNS PROTEKTOR® WHEELCHAIR AND OCCUPANT RESTRAINT SYSTEM FULFILLS THE EU DIRECTIVE 2007/46/EG WHICH CAME INTO FORCE ON 1ST NOVEMBER 2014.

ATTENTION!

The vehicle manufacturer's body fitting guidelines must be adhered to and AMF-Bruns original parts need to be used for the installation!

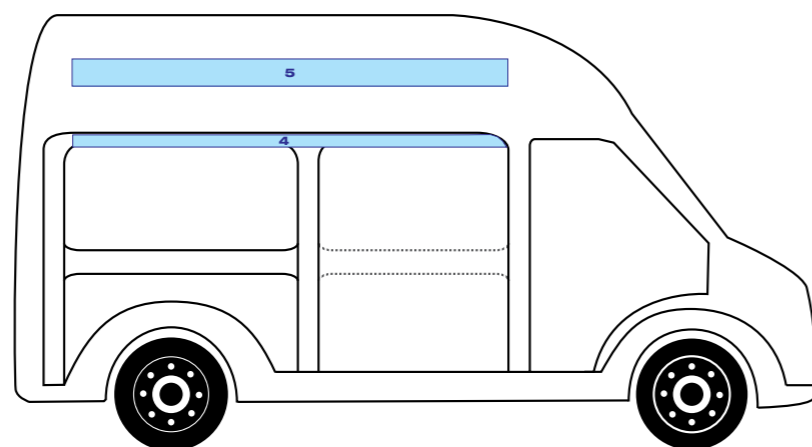

Vehicle Model without Trim	Area	Assembly material Mounting rail 1 m	Assembly material Mounting rail 3 m	Mounting rail 1 m	Mounting rail 3 m
Peugeot Boxer / Fiat Ducato	4	1001 9571	1001 9572	H150 132	H150 136
Citroen Jumper					
Ford Transit	4	1001 9578	1001 9579	H150 132	H150 136
Nissan NV400 / Opel Movano	4/5	1001 9578	1001 9579	H150 132	H150 136
Renault Master	4/5	1001 9578	1001 9579	H150 132	H150 136
Volkswagen Crafter NEW/MAN TGE	4	1002 3548	1002 3549	H150 132	H150 385
Mercedes-Benz Sprinter	4	1001 9680	1001 9681	H150 132	H150 385
Volkswagen T5 T6	4	1001 9578	1001 9579	H150 132	H150 136

SINGLE POINT SOLUTION

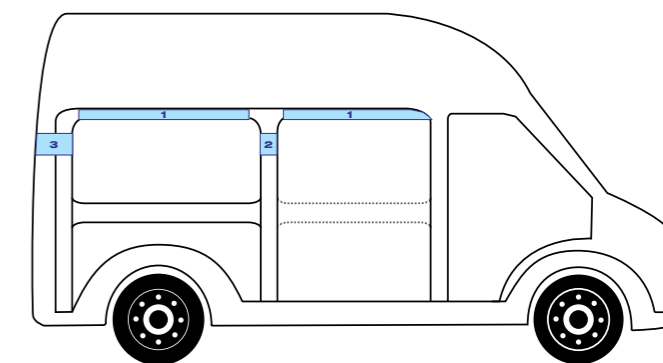

Vehicle Model	Area	Part No. with Trim	Part No. without Trim
Peugeot Boxer/ Fiat Ducato	1	1001 9565	1001 9564
Citroen Jumper	2	1001 9564	1001 9564
	3	1001 9563	1001 9562
Citroen Spacetourer, Peugeot Traveller, Toyota Proace	2	-	10023562
	2	-	10023562
Ford Transit F7 (V363)	1	1001 9665	1001 9665
	2	1001 9574	1001 9574
	3	1001 9564	1001 9564
Ford Transit Custom	1	1001 9564	1001 9564
	2	1001 9573	1001 9573
	3	1001 9574	1001 9574
Volkswagen Crafter (new) / MAN TGE	1	1002 3278	1002 3278
	2	1002 3278	1002 3278
	3	1002 3278	1002 3278
Mercedes-Benz Vito	2	1001 9679	1001 9679
	3	1001 9678	1001 9679
Volkswagen Crafter (old)	1	1001 9676	1001 9676
Mercedes-Benz Sprinter	1	1001 9676	1001 9676
Nissan NV300 / Opel Vivaro	1	1001 9564	1001 9564
Renault Trafic / Fiat Talento	2	1001 9564	1001 9564
	3	1001 9574	1001 9574
Nissan NV400 / Opel Movano	1	1001 9577	1001 9576
Master	2	1001 9564	1001 9564
	3	1001 9562	1001 9562
Volkswagen T6	1*	1001 9574	1001 9574
	2	1001 9574	1001 9574

* Only Transporter and Kombi

FOR PASSIVE DRIVERS



AMF-Bruns provides tested head and backrest for wheelchair users. Only AMF-Bruns possesses patented 20 G front impacted and 10 G rear impacted head & back supports.

- Maximum confidence
- Reliable, space-saving and comfortable
- Complies with dynamic crash tests (Euro-NCAP 10 G rear-end collision)
- Suitable for minibuses and cut floor vehicles
- Includes approved integrated 2-point shoulder belt
- Height-adjustable – fits different wheelchairs
- Easy to handle in the vehicle
- Separate, 180° rotatable head- and back support
- Optional: On lockable for Smartfloor application (easy removable)
- The FutureSafe floor mounted i.c.w. Smartfloor is a TÜV tested solution for shoulderbelt use.



With the easy to use head- and backrest FUTURESAFE®, AMF-Bruns is setting a new standard of safety.

- Various crashtests show clearly: FUTURESAFE® ensures the highest level of safety in case of a rear impact.
- On the top of this the integrated shoulderbelt ensures the essential safety in case of a front impact.
- FUTURESAFE® - The only incorporated safety system with head- and backrest.

Item code	Vehicle	Driving direction	Shoulder belt height adjustable	Foot
200926179	Caddy 5	left	no	short
200938357	Caddy 5	left	yes	short
200938359	Caddy 5	right	no	short
200938362	Caddy 5	right	yes	short
200938483	Stellantis (K9 + K0) vgl. Modelle MB Vito / V-Klasse / EQV Ford Connect (Modell bis 2019) Renault Trafic / Fiat Talento VW Caddy 4	left	no	long
200938484	Stellantis (K9 + K0) vgl. Modelle MB Vito / V-Klasse / EQV Ford Connect (Modell bis 2019) Renault Trafic / Fiat Talento VW Caddy 4	left	yes	long
200938485	Stellantis (K9 + K0) vgl. Modelle MB Vito / V-Klasse / EQV Ford Connect (Modell bis 2019) Renault Trafic / Fiat Talento VW Caddy 4	right	no	long
200938486	Stellantis (K9 + K0) vgl. Modelle MB Vito / V-Klasse / EQV Ford Connect (Modell bis 2019) Renault Trafic / Fiat Talento VW Caddy 4	right	yes	long
200938494	MB Citan C420 Renault Kangoo RFK	left	no	short
200938495	MB Citan C420 Renault Kangoo RFK	left	yes	short
200938496	MB Citan C420 Renault Kangoo RFK	right	no	short
200938497	MB Citan C420 Renault Kangoo RFK	right	yes	short
200938514	Dokker	left	no	long
200938515	Dokker	left	yes	long
200936346	Large vehicle	left	no	long
200938364	Large vehicle	left	yes	long
200938368	Large vehicle	right	no	long
200938366	Large vehicle	right	yes	long
200937642	Wall	left	yes	
200938374	Wall	right	yes	
200940826	Wall	left	no	
200940825	Wall	right	no	

FOR ACTIVE DRIVERS

Specification

- Maximum assurance, 15 G crash tested
- Height-adjustable – fits different wheelchairs
- 90° rotatable head and back support
- Single solution for active drivers on market according to ISO 10542, Part M
- Easy to operate in the vehicle via a switch on the dashboard
- Compatible with EMC in accordance with the European legislation
- Available for Volkswagen T6 and Mercedes-Benz V-Class



Item code	Item name
200406060	eFutureSafe Head & Backrest for LHD

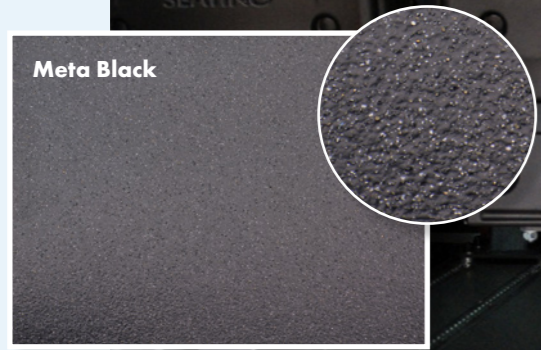
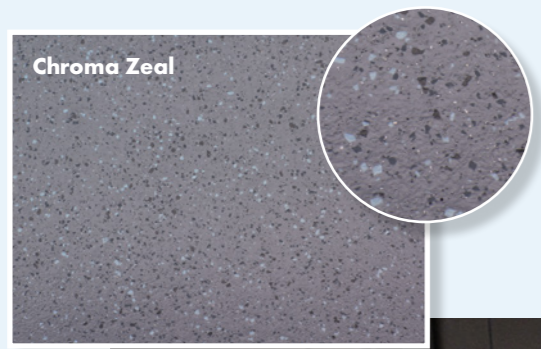
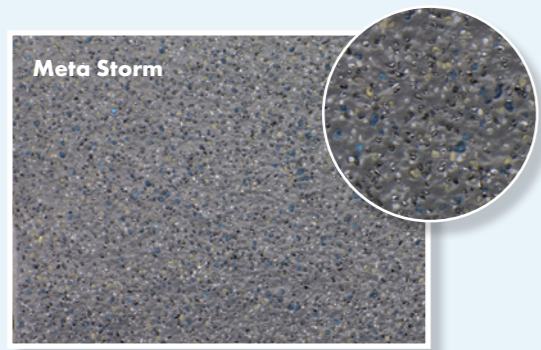

Smartfloor floor covering is especially designed for intensive use in the transport sector. The anti-skid surface makes this wear-resistant floor covering a perfect and durable solution for use in vehicles and for the conveyance of passengers.

- Safe anti-skid principle, even in wet conditions
- Durable and hard-wearing
- Colour fast throughout the active service life
- Flexible to install near wheel housing and boarding structures
- Dirt-resistant and easy to clean
- Saves fuel thanks to low weight

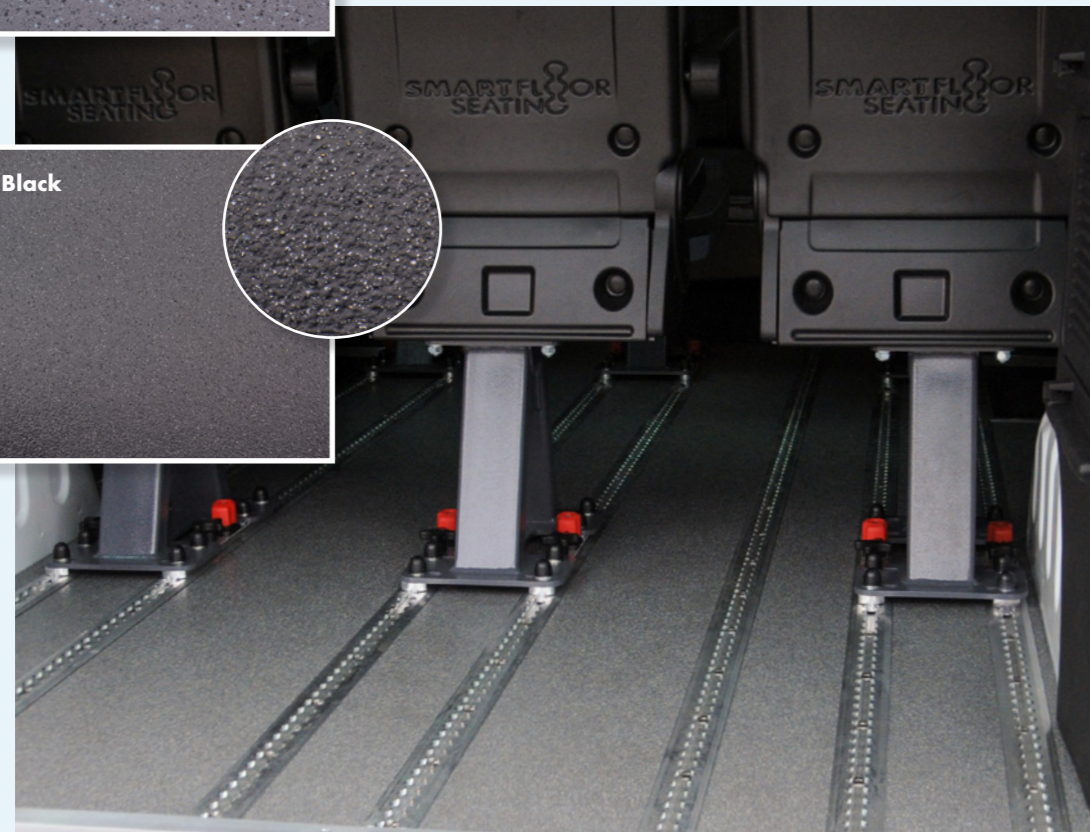

Composition

Matrix	High-quality vinyl
Ingredients	Aluminium oxide pellets, silicium carbide in the wearing course, quartz basic colour in the surface layer with additional coloured chips for the Altro Transflor Chroma series
Structure support	Polyester cellulose reinforced with glass fibre
Backing	Polyester cellulose
Optional backing	Backing with polyester-like structure (see Altro supplier)

Recommended cleaning method

Thanks to the technical development of Altro safety floors, the floors are considerably easier to clean. Visit www.altro.com/us/products/altro-transflor-meta for extensive cleaning advice from Altro Transflor.

Installation and maintenance

All fitting must be carried out in accordance with the local standards and the Altro Transflor installation manual.

Sub-floor and adhesives In accordance with the recommendations in the Altro Transflor installation manual (see also www.altro.com/us/products/altro-transflor-meta)

Note: failure to comply with the Altro Transflor installation instructions can lead to reduced performance and slip resistance of the floor. The floor must be thoroughly cleaned before delivery and protected during other work.

Altro Transflor Meta and Chroma are not suited for spaces in which it is allowed to smoke, as the risk of burning cigarettes compromising the floor is too high.

Choice of colour

When choosing the colour of the Altro Transflor floor, the volume of traffic in the room must be taken into account. When in doubt, please contact Smartfloor.

Item code	Item name	Measurement
10024297	Carpet Altro Storm Self-Adhesive	19 x 2 Mtr
10024404	Carpet Altro Meta Black Self-Adhesive	19 x 2 Mtr





Item code	Item name
H20178	AMF Stretcher
H20187	Mounting kit AMF for Stretcher

These facts make all the difference

- High-precision manoeuvring in various height levels, e.g. for hospital beds, x-ray tables, CT etc.
- The quick-release-fixing allows for an easy fitting to the vehicle's floor
- Big wheels ensure smooth operation on uneven grounds
- The AMF-Bruns stretcher is fully hydraulically adjustable
- The AMF-Bruns stretcher allows for an ergonomic operation.
- The stretcher's suspension guarantees gentle transportation
- The AMF-Bruns stretcher is 10G TÜV tested in all directions according to DIN EN 1789
- In connection with Smartfloor the stretcher can be fixed in various ways to the vehicle - the ideal, flexible solution for the combination of wheelchair and horizontal transportation





THESE FACTS MAKE ALL THE DIFFERENCE

- Fully electric step - automatically deploys when opening the side door and stows when closing the door
- Compact, robust design
- Anti-slip surface
- High-quality processing, absolutely weatherproof
- Powerful motor
- Visual warning signal (dashboard) when step is deployed
- Anti-pinch protection (step stops in case of an obstacle)
- No modification to the vehicle body necessary
- Complies with DIN 75078 and covers 70 % of the vehicle entrance area

Item Code	Item name	Width
10025594	Electric side step fully automatic	600 mm
10025595	Electric side step fully automatic	900 mm
10025596	Electric side step fully automatic	1100 mm

Side Steps
Electric Side Step - Fitting kits

Chassis	Vehicle	From	Length	Wheelbase
VW	T6	2015	L1/L2	3003 / 3403
	Crafter / MAN TGE	2017	L3/L4/L5	
X82	Traffic / NV300 / Vivaro II (2014-2018) / Talento II / Primastar >2022	2014	L1	3100
X82	Traffic / NV300 / Vivaro II (2014-2018) / Talento II / Primastar >2022	2014	L2 / L3	3500
X62	Master/ MOVANO B / NV400 / Interstar (2022)	2010	L1 / L2 / L3	3500
X62	Same kits on Electric vehicles			
K0	Expert / Traveller/ Jumpy / Proace/ Vivaro III >2019 / Zafira >2020	2016	L1	2925
K0	Expert / Traveller/ Jumpy / Proace/ Vivaro III >2019 / Zafira >2020	2016	L2 / L3	3275
EK0	Same kits on Electric vehicles			
K9	Rifter / Berlingo / Partner III / Proace City / Combo D	2019	L1	2785
K9	Rifter / Berlingo / Partner III / Proace City / Combo D	2019	L1	2975
X2/50	Boxer / Jumper / Ducato / Movano C (from 2021) Right-hand drive	2010	L1	3000
X2/50	Boxer / Jumper / Ducato / Movano C (from 2021) Left-hand drive	2010	L1	3000
X2/50	Boxer / Jumper / Ducato / Movano C (from 2021) Right-hand drive	2010	L2	3450
X2/50	Boxer / Jumper / Ducato / Movano C (from 2021) Left-hand drive	2010	L2	3450
X2/50	Boxer / Jumper / Ducato / Movano C (from 2021) Right-hand drive	2010	L3 / L4	4035
X2/50	Boxer / Jumper / Ducato / Movano C (from 2021) Left-hand drive	2010	L3 / L4	4035
Ford	Transit Custom / Custom mHEV pHEV / hybrid	2012	L1	2933
Ford	Transit Custom / Custom mHEV pHEV / hybrid	2012	L2	3300
Ford	Transit F7 Propuls/traction/pHEV FWO/RWD/hybrid	2013	L2	3300/3750
910	Mercedes Sprinter VS30 FWD	2018	L1	3259
910	Mercedes Sprinter VS30 FWD	2018	L2 / L3	3924
906-907	Mercedes Sprinter VS30 RWD	2013	L1	3250
906-907	Mercedes Sprinter VS30 RWD	2013	L2 / L3 / L4	3665 / 4325
447	Mercedes Vito / V Klasse	2015	L1 L2	3200 / 3430
All	Option E-Smartstep	All	All	All

Side Steps
Electric Side Step - Fitting kits

10025594 (600mm)		10025595 (900mm)		10025596 (1100mm)	
Door right Item Code	Door left Item Code	Door right Item Code	Door left Item Code	Door right Item Code	Door left Item Code
10025575	*	10025575	*	*	*
10025590	*	10025590	*	10025590	*
10025578	10025579	*	*	*	*
10025578	10025579	10025735	10025736	*	*
10025582	10025582	10025582	10025582	10025582	10025582
10025576	10025576	*	*	*	*
10025576	10025576	10025576	10025576	*	*
10025592	*	*	*	*	*
10025592	10025592	*	*	*	*
*	10025577	*	*	*	*
10025577	*	*	*	*	*
*	10025577	*	10025577	*	*
10025577	*	10025577	*	*	*
10025577	10025577	10025577	10025577	*	10025577
10025577	10025577	10025577	10025577	10025577	*
10025580	10025580	*	*	*	*
10025580	10025580	10025581	10025581	*	*
10025593	10025593	10025593	10025593	10025593	10025593
10025584	10025584	*	*	*	*
10025583	10025583	10025583	10025583	10025583	10025583
10025583	10025583	10025583	10025583	*	*
10025583	10025583	10025583	10025583	10025583	10025583
10025588	*	10025589	*	*	*
		10025680			

* Impossible fitting due to equipments under the chassis

Side Steps
High folding side step for sliding doors

Closes the entire entry step when folded up thus creating additional floor space for a wheelchair.

- Easy and fast handling
- Non-slip ribbed surface
- Absolutely noise-free while driving
- Load capacity 150 kg
- Manual handed operation
- Complies with DIN 75078 and covers at least 70% of the vehicle entrance area

Item Code	Vehicle	Wheelbase			Drive		Side step depth	Side step width	Total width	Weight
		LWB	MWB	SWB	Back	Front				
H20080	Mercedes Benz Sprinter	x	x		x		180 mm	1190 mm	1310 mm	18 kg
H20080	Volkswagen Crafter (until 2016)	x	x		x		180 mm	1190 mm	1310 mm	18 kg
H20081	Mercedes Benz Sprinter			x	x		180 mm	770 mm	890 mm	15 kg
H20081	Volkswagen Crafter (until 2016)			x	x		180 mm	770 mm	890 mm	15 kg
H20085	Volkswagen T5/T6, only Transporter	x		x		x	140 mm	820 mm	940 mm	8 kg



Side Steps
Rigid side step for sliding door

The fixed step is mounted on the side door under the vehicle. The hot-dip galvanized steel construction makes it particularly robust and weather-resistant. Step with general Vehicle Type approval (ABE). Installation does not require any further examination by the TÜV.

SPECIFICATION

- Robust steel construction (slip resistance R15)
- Load capacity 150 kg
- Complies with DIN 75078 and covers at least 70 % of the vehicle entrance area
- Comfortable access
- No electrical connection required

Model	Item code	Vehicle type	Wheelbase			Drive		Step depth	Step width	Total width	Weight
			LWB	MWB	SWB	RWD	FWD				
L/F	200922933	Ford Transit F7	x	x			x	190 mm	1445 mm	1475 mm	20 kg
L/G	200923222	Ford Transit F7	x	x			x	190 mm	1445 mm	1475 mm	20 kg
K/H	200581833	Ford Transit Custom	x		x		x	190 mm	1150 mm	1180 mm	13 kg
K/B	200923219	Volkswagen T5 / T6	x		x		x	190 mm	1150 mm	1180 mm	15 kg
L/J	200923597	Mercedes-Benz Sprinter (VS03)	x	x			x	190 mm	1445 mm	1475 mm	21 kg
K/J	200923598	Mercedes-Benz Sprinter (VS30)			x		x	190 mm	1150 mm	1180 mm	20 kg
L/I	200510676	Volkswagen Crafter / MAN TGE	x	x			x	190 mm	1445 mm	1475 mm	20 kg
L/C	200167109	Mercedes-Benz Sprinter / Volkswagen Crafter (until 2016)	x	x			x	190 mm	1445 mm	1475 mm	21 kg
K/C	200167159	Mercedes-Benz Sprinter / Volkswagen Crafter (until 2016)			x		x	190 mm	1150 mm	1180 mm	19 kg
K/D	200923183	Peugeot Boxer	x	x			x	190 mm	1445 mm	1475 mm	15 kg
K/D	200923183	Citroën Jumper	x	x			x	190 mm	1445 mm	1475 mm	15 kg
K/D	200923183	Fiat Ducato	x	x			x	190 mm	1445 mm	1475 mm	15 kg



Ramps

- Aluminium
- Centre-folding
- Fitted with quick locking system
- Robust: 20G collision-tested
- Weight ranging from 35 kg to 46 kg, depending on type
- Easy operation with two handles and pneumatic absorber
- Extreme no slippery surface (R11)
- Single hand operation
- Options: * 90° opening
* extra support 200 KG capacity increase



Extra support

Item number	description	dimension	load
H20115	Euro-Rampe	2.00 m x 0.80 m	300 kg
H20101	Euro-Rampe	2.40 m x 0.60 m	300 kg
H20104	Euro-Rampe	2.40 m x 0.70 m	300 kg
H20110	Euro-Rampe	2.40 m x 0.80 m	300 kg
H20107	Euro-Rampe	2.40 m x 0.90 m	300 kg
H20133	Euro-Rampe	2.40 m x 1.20 m	300 kg
H20114	Euro-Rampe	2.80 m x 0.90 m	300 kg
H20116	Euro-Rampe	2.80 m x 1.20 m	300 kg
On request	Euro-Rampe with 90° opening facility		
On request	Euro-Rampe with extra support (200 kg capacity increase, 500 kg total load)		



90° opening facility

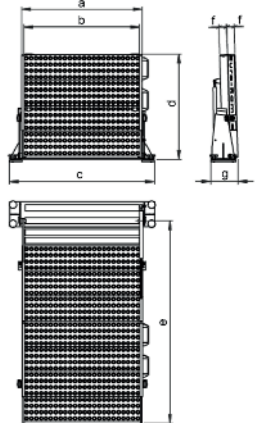

Measurement (mm)	Description	Measurement (mm)						
		A	B	C	D	E	F	G
2.400 x 600	standard	640	600	830	1.230	2.390	60	215
	swivelling			970	1.245			
2.400 x 700	standard	740	700	930	1.230	2.390	60	215
	swivelling			1.070	2.045			
2.400 x 900	standard	950	910	1.140	1.230	2.390	80	230
	swivelling			1.280	1.245			
2.400 x 800	standard	840	800	1.030	1.230	2.390	60	215
	swivelling			1.170	1.245			
2.800 x 900	standard	950	910	1.140	1.430	2.780	100	245
	swivelling			1.280	1.440			
2.000 x 800	standard	840	800	1.030	1.030	1.990	60	215
	swivelling			1.170	1.045			

Fully automatic lift for rear or side door. The AL1 uses aluminium profiles for the unique design of its purpose-built lifting arms. The newly designed aluminum arms make the AL1 the lightest patented lift on the market. The transparent design of the linear platform lift provides excellent rearward visibility.

These points count:

- Patented, newly developed aluminum arms make the AL1 the lightest lift on the market.
- Unique design
- Can be used for rear and side entry
- LED warning lights, optional LED ramp lighting
- Ramp design ensures excellent rear visibility.
- Special safety brake works automatically after contact with the ground, even on uneven terrain
- Access grid serves as an automatic safety brake (patented)
- Crash safety stops for greater passive safety
- High-quality powder-coated finish, with CDP coating as additional corrosion protection
- EMC-tested in accordance with EU directives
- Meets EN 1756, II and DIN 75078, 1
- 20G collision tested



Technical data

- 900 mm lift height
- Load capacity 400 kg
- Weight Depends on ramp size between 120 kg and 130 kg
- Operation single-handed with 4 push buttons (up/down, park/operate)
- Manual pump, two rails, automatic warning lights
- Power, 12 V electro hydraulic motor

Optional

- Bluetooth remote control or App operation (IOS, Android).
- Remote control available
- 20G tested mounting kits for vehicle models like Mercedes-Benz Sprinter, Volkswagen Crafter, Volkswagen T6, Renault Master, Opel Movano, Ford Transit

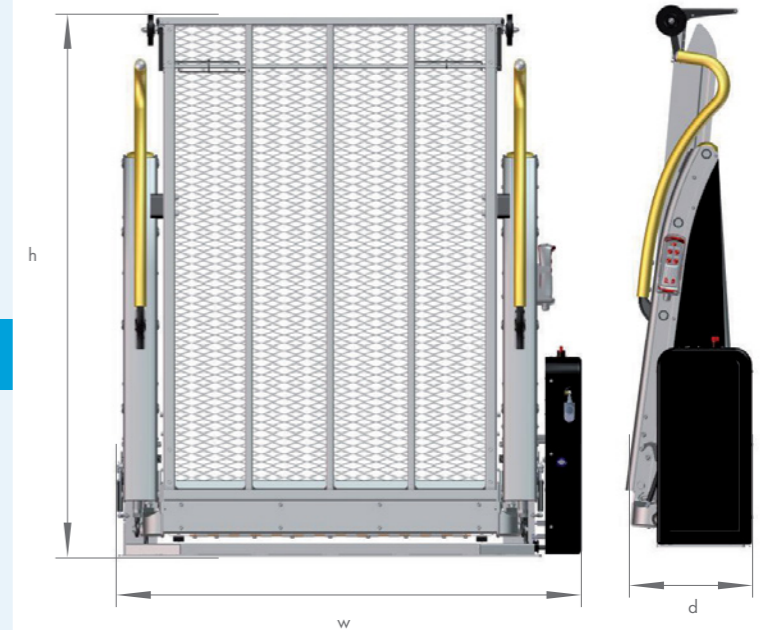

Item code	10018371	10018372	10018373
TYPE	AL1 1380	AL1 1130	AL1 1065
Width (w)	1,290 mm	1,200 mm	1,120 mm
Depth (d)	350 mm	350 mm	350 mm
Height (h)	1,500 mm	1,250 mm	1,185 mm

Useful ramp sizes			
Width	920 mm	830 mm	750 mm
Length	1,380 mm	1,130 mm	1,065 mm

	Item Code	Jumper Boxer Ducato	Sprinter Crafter	T5/T6 only Transporter	Ford Transit	Ford Transit MY2015	Ford Transit Custom	B Vito V-Klasse	Master Movano NV400	Traffic Vivaro NV300 Talento
AL 1 1380	10018371	x 1)	x 2)		x 2)	x 2)	x 1)		x 1) 2)	
AL 1 1130	10018372	x	x	x 2)	x	x	x 2)		x	x 2)
AL 1 1065	10018373	x	x	x	x	x	x		x	x

1) Not suitable for vehicle height H1

2) Mountingkit available

No liability whatsoever can be accepted for variations due to technical changes or vehicle-specific equipment. Please feel free to contact Smartfloor if you are in any doubt.

Linear lifts
AMF-BRUNS - AL1 Split Platform Lift

Fully automatic lift for rear or side door. The AL1 uses aluminium profiles for the unique design of its purpose-built lifting arms. The newly designed aluminum arms make the AL1 the lightest patented lift on the market. The split ramp ensures a clear view to the rear yet allows entry and exit through the rear door.

Benefits

- Patented, newly developed aluminum arms make the AL1 the lightest lift on the market.
- Can be used for rear and side entry
- LED warning lights, optional LED ramp lighting
- Three standard ramp sizes available
- Ramp design ensures excellent rear visibility.
- Special safety brake works automatically after contact with the ground, even on uneven terrain
- Access grid serves as an automatic safety brake (patented)
- Quiet ride with rubber-mounted ramp in stowed position
- Crash safety stops for greater passive safety
- EMC-tested in accordance with EU directives
- Meets EN 1756, II and DIN 75078, 1
- 20G collision tested



Linear lifts
AMF-BRUNS - AL1 Split Platform Lift

Technical data

- Load capacity 400 kg
- 900 mm lift height
- High-quality powder-coated finish, with CDP coating as additional corrosion protection
- Single-handed with 4 push buttons (up down, park/ operate)
- Weight depends on ramp size; between 122 kg and 140 kg
- Manual pump, two rails, automatic warning lights

Option

- Bluetooth remote control or App operation (IOS, Android).
- Remote control available
- 20G tested mounting kits for most vehicle models.

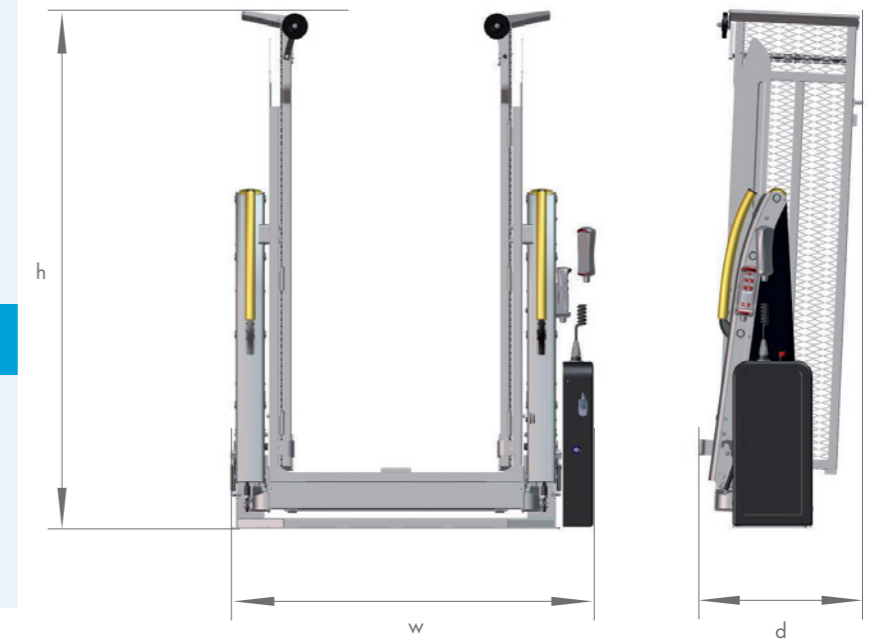

Item code	10018378	10018379	10018380
TYPE	Split 1300	Split 1085	Split 1085S
Width (w)	1,200 mm	1,120 mm	1,040 mm
Depth (d)	500 mm	500 mm	500 mm
Height (h)	1,405 mm	1,190 mm	1,190 mm

Useful ramp sizes			
Width	830 mm	750 mm	670 mm
Length	1,300 mm	1,085 mm	1,085 mm

	Item Code	Jumper Boxer Ducato	Sprinter Crafter	Ford Transit	Ford Transit MY2015	Ford Transit Custom	Master Movano NV400	Traffic Vivaro NV300 Talento
Split 1300	10018378	x 1)	x 1)	x 1)	x 1)		x 1)	
Split 1085	10018379	x	x	x	x	x	x	x
Split 1085S	10018380	x	x	x	x	x	x	x

1) Not suitable for vehicle height H1

No liability whatsoever can be accepted for variations due to technical changes or vehicle-specific equipment. Please feel free to contact Smartfloor if you are in any doubt.

Fully automatic lift for rear or side door. The AL1 uses aluminium profiles for the unique design of its purpose-built lifting arms. The newly designed aluminum arms make the AL1 the lightest patented lift on the market. The panorama platform allows the installation of a large lift in vehicles with low interior height.

Benefits

- Patented, newly developed aluminum arms make the AL1 the lightest lift on the market.
- Unique Design
- Can be used for rear and side entry
- LED warning lights, optional LED ramp lighting
- Two standard ramp sizes available
- Ramp design ensures excellent rear visibility.
- Suitable for vehicles with a low roof
- Special safety brake works automatically after contact with the ground, even on uneven terrain
- Access grid serves as an automatic safety brake (patented)
- 900 mm lift height
- Crash safety stops for greater passive safety
- High-quality powder-coated finish, with CDP coating as additional corrosion protection
- EMC-tested in accordance with EU directives
- Meets EN 1756, II and DIN 75078, 1
- 20G collision tested



Technical data

Load capacity 400 kg
Single-handed operation with 4 push buttons (up/down, park/operate)
Weight depending on platform size; between 135 kg and 140 kg
Manual pump, two rails, automatic warning lights

Option

- Bluetooth remote control or App operation (IOS, Android).
- Remote control available
- 20G tested mounting kits for vehicle models like Mercedes-Benz Sprinter, Volkswagen Crafter, Volkswagen T6, Renault Master, Opel Movano, Ford Transit

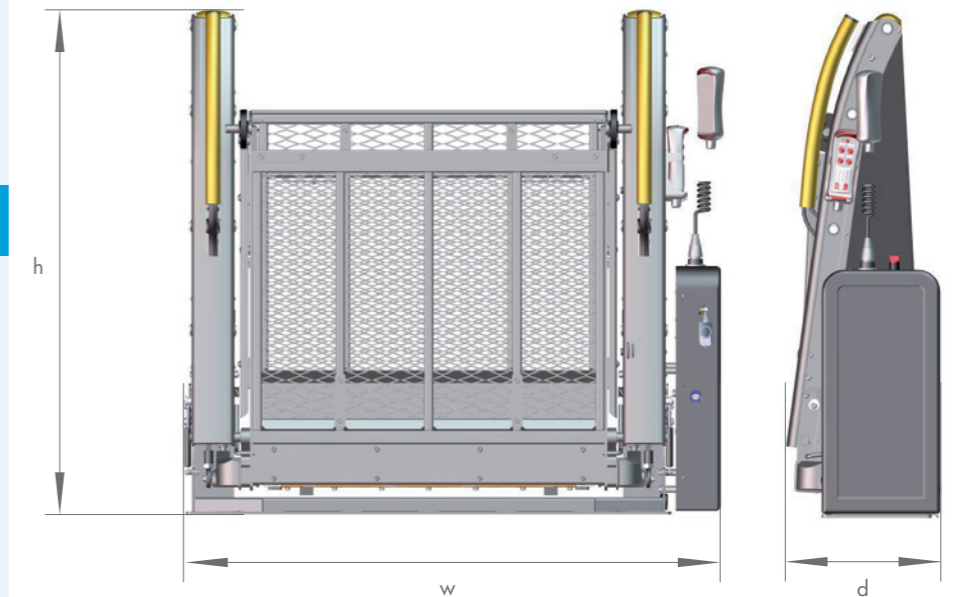

Item code	10018375	10018374
TYPE	AL1 1200	AL1 1400
Width (w)	1,200 mm	1,200 mm
Depth (d)	350 mm	350 mm
Height (h)	1,125 mm	1,125 mm

Useful ramp sizes		
Width	755 mm	755 mm
Length	1,200 mm	1,400 mm

		Jumper Boxer Ducato	Sprinter Crafter	T5/T6 only Transporter	Ford Transit	Ford Transit MY2015	Ford Transit Custom	B Vito V-Klasse	Master Movano NV400	Traffic Vivaro NV300 Talento
	Item Code									
AL1	1400	10018374	x	x	x 2)	x	x	x	x	x
AL1	1200	10018375	x	x	x 2)	x	x	x	x	x

2) Mountingkit available

No liability whatsoever can be accepted for variations due to technical changes or vehicle-specific equipment. Please feel free to contact Smartfloor if you are in any doubt.



Smartfloor offers AL1 mounting kits for the following vehicle types:



Item Code	Vehicle type	Vehicle Floor	Direction of travel	AL1 Lift	Instruction GER	EN
H1402	Opel Movano / Renault Master	Original floor / Smartfloor	right	AL1 Solid 1380	10018293	10018489
H1400	Mercedes-Benz Sprinter / VW Crafter (old)	Original floor / Smartfloor	right	AL1 Solid 1380	10018292	10018488
H1404	Ford Transit	Original floor / Smartfloor	right	AL1 Solid 1380	10018291	10018487
H1406	Ford Transit F7	Original floor / Smartfloor	right	AL1 Solid 1380	10019784	10022312
H1407	Ford Transit Custom	Original floor / Smartfloor	right	AL1 Solid 1130 Panorama 1200/1400	10022409	10022410
H1407	Ford Transit Custom (without air condition)	Original floor / Smartfloor	right	AL1 Solid 1380	10022409	10022410
H1408	Opel Vivaro / Renault Trafic / Fiat Talento / Nissan NV300	Original floor / Smartfloor	right	AL1 Solid 1130/1200 Panorama 1200/1400	10022431	10022934
H1409	Mercedes-Benz Vito / V-Class	Original floor	right	Panorama 1200/1400	10022407	10022408
200460048	VW Crafter / MAN TGE (new)	Smartfloor	right	AL1 Solid 1380	10022932	10022933
H1405	VW T5 / T6	Smartfloor	right	Panorama 1200/1400	10018294	10018490
H1410	VW T5 / T6 Multivan	Original floor	right	Panorama 1200/1400		
-	Fiat Ducato		right			

Optional

AMF-Bruns has developed a standardised operation for all cassette and linear lifts. Standard operation of the newly developed control unit (for cassette and linear lift) is a hand control with cable connection to the lift. Additionally a remote control unit is available as a wireless version, with handset operation or new smartphone app (iOS, Android).



Mobile operation via App

- Intuitive operation
- Mobile remote control covers all functions and tools from the original remote control
- Available for Smartphones (iOS and Android)

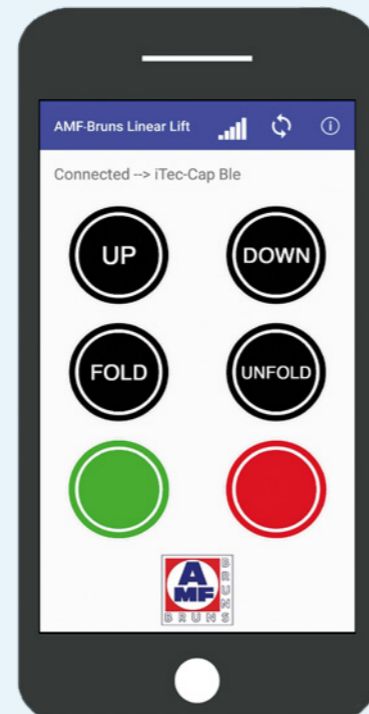

The ultra-slim AMF-Bruns cassette lift for the side loading door

The cassette lift K70 is the flattest back-in-the-box lift of its kind for the side door. The lift is installed underneath the vehicle floor in order to make the best possible use of the available space within the vehicle. The large lifting platform is suitable for large electric wheelchairs. The cassette lift K70 is only suitable for vans such as Volkswagen T6 or Renault Trafic L2.

Specification

- Load capacity 300 kg, complies with EN 1756, II
- Ultra-slim design (70 mm) guarantees ultimate ground clearance
- New illuminated controls, waterproof and shockproof (!)
- Automatic barrier operates on uneven roads and snow, too!
- Original step is obtained
- Vehicle interior remains unchanged
- Powerful, quiet action ensures smooth operation of the lifting platform
- Totally enclosed stainless steel box provides protection for the lift system even in extreme weather conditions
- Manual emergency operation
- No changes to the car body necessary
- EMC tested according to EU-regulation 95/54/EG/EC
- Original tank is replaced by an AMF-Bruns tank (only Diesel engine)
- Obtaining original tank at bad road suspension

Technical Data

» Hight	70 mm	» Deploying/ stowing	Approx. 12 sec.
» Load capacity	300 kg	» Control	By push buttons
» Platform size	Approx. 760 x 1.200 mm	» Power	Lifting and lowering electro-hydraulic 12 V; deploying and stowing driven by 12 V electric motor
» Unladen weight	Approx. 170 kg		
» Lifting/Lowering	Approx. 7 sec.		

Optional

Bluetooth remote control or app operation (iOS, Android)



K90

A cassette lift is installed underneath the vehicle floor in order to make the best possible use of the available space within the vehicle. A cassette lift can be installed at the side of the vehicle. The AMF-Bruns cassette lifts are only suitable for installation in passenger transport vans such as VW T6 and larger. We provide special rear-squat solutions for passenger vehicles.

- Load-bearing capacity of up to 300 kg
- Platform is also suitable for electric wheelchairs
- Easy electro-hydraulic dual-button operation
- Ultra-slim design to save floor space within the vehicle
- No alterations in the vehicle needed
- Fitted with manual emergency operation
- Platform weight 140 kg

K90 Active

1 METER OF FREE SPACE IS ENOUGH

The AMF-Bruns K90 Active lift is a high-quality cassette lift for active and independent wheelchair users.

Extremely suitable for narrow parking spaces

Narrow parking spaces are no longer an obstacle, thanks to a platform width of less than 70 cm on the ground. For maximum ease of use, the lift platform can be accessed from both sides, parallel to the linear direction of the vehicle. Ideal in parking spaces with cars parked on both sides of the vehicle, or in a busy street with cars parked both in front and behind the vehicle.

Ultra-slim

As so little space is needed, the K90 Active is easy to install. The lift is fitted underneath the vehicle's sliding door at the right side of the vehicle. Thanks to its ultra-slim design, you only need a maximum of 90 mm underneath the vehicle to install it. The vehicle's interior remains fully intact. This lightweight lift guarantees quick, simple and convenient use.



- Lift platform accessible from two sides
- Load-bearing capacity of up to 200 kg
- Fast and simple to operate
- Ultra-slim design to save floor space within the vehicle
- No need for vehicle alterations to the bottom

The K90 Active can only be installed in passenger vans such as Volkswagen T6 and larger.

K90



K90 Active



Item Code	Description	Dimensions (w x h)
10023012	K70	760 x 1.200 mm
10023013	K70 with lateral access	760 x 1.200 mm
H 9000	K90	800 x 1.200 mm

Underfloor Cassette Lifts - Vehicle Matrix

Vehicle model	K70 side mounted	K90 side mounted
Jumper / Relay / Boxer / Ducato (not SWB)	No	Yes
Ford Transit (only FWD)	No	Yes
Vito / V-Class (not petrol derivatives)	Yes	Yes
Sprinter / Crafter	No	Yes
Master / Movano / NV 400 (not SWB)	No	Yes
Volkswagen T5 (not V6 petrol or 4Motion derivatives)	Yes	Yes
Volkswagen T6 (not petrol derivatives)	Yes	Yes (2)

Yes (1) = only right side of vehicle

Yes (2) = also with 4Motion

Cassette lift K90 Active on request.

Telescopic ramps for side and rear doors

When required the ramps are positioned one after the other on the edge of the vehicle door. Roll the wheelchair over the ramps into the vehicle. This can be an empty wheelchair as well as one carrying an occupant. When not needed, the telescopic aluminium ramps can be conveniently stored in the vehicle. It should be noted that the ramps are extremely light and can be carried in much the same way, for example, as a carrier bag by the handles on the side.

- Load capacity: up to 2 x 150 kg
- Total length: 2 m (collapsed 1.2 m)
- Weight: approx. 12 kg
- Easy to handle, easy to operate
- Stable construction
- Extremely lightweight due to special aluminium profiles
- Foldable to manageable dimensions
- Easy carrying with the provision of a grab handle
- Applicable for all estate vehicles
- Suitable for all combi-vehicles
- Can be mounted on the rear or side doors
- Slip resistance class R11

Item code	Item name	Length
10022633	Channel Ramp	2 m

AMF-Bruns Telescopic Ramp





Technical data

- Raising / lowering mechanism: Powerful, low noise 12V hydraulic power unit
- Drive: Electro-hydraulic from the vehicle battery
- Lowering control: Rocker switch in the rear of the vehicle
- Raising control: Automatically when rear door is being closed

Optional

Ramps in different sizes (see ramps)



Vehicle ready for departure (standard height).

Lowered vehicle.

Item code	Vehicle model	Including
10022600	Volkswagen Crafter (old) MWB / Mercedes-Benz Sprinter MWB	Hydraulic kit for lowering suspension – without ramp
10022601	Volkswagen Crafter (old) LWB / Mercedes-Benz Sprinter LWB	Hydraulic kit for lowering suspension – without ramp
10023226	Fiat Ducato / Citroën Jumper / Peugeot Boxer / Dodge RamMaster	Hydraulic kit for lowering suspension – without ramp
10023007	Volkswagen Crafter / MAN TGE	Hydraulic kit for lowering suspension – without ramp
10023266	Volkswagen T5 / T6	Hydraulic kit for lowering suspension – without ramp
10023273	Ford Transit (F7) MWB	Hydraulic kit for lowering suspension – without ramp
10023279	Ford Transit (F7) LWB	Hydraulic kit for lowering suspension – without ramp
10022613	Renault Master / Opel Movano / Nissan NV400	Hydraulic kit for lowering suspension – without ramp



A vehicle with a rear cut floor is the ideal solution for passive drivers. The rear cutout with access ramp allows the wheelchair user to be transported comfortably. The non-slip ramp allows easy access to the vehicle, where there is plenty of space in the passenger compartment due to the lowered floor pan. Protektor wheelchair & occupant restraint systems are provided to secure both the wheelchair and the wheelchair occupant. Extra protection is provided by the FutureSafe head & backrest.

THESE FACTS MAKE ALL THE DIFFERENCE:

- Rear cut floor with access ramp
- Spacious passenger cabin
- Protektor wheelchair & occupant restraint system (ISO approved)
- Extra long front electric belts for the wheelchair
- Optional: EasyFlex ramp can be converted quickly to a loading area – ideal for flexible use of the vehicle, FutureSafe head & backrest, Tip & Fold seats

REAR CUT FLOOR IS AVAILABLE FOR FOLLOWING VEHICLE MODELS:

CITROËN Berlingo	MERCEDES-BENZ Citan/T-Class	PEUGEOT Rifter
CITROËN ë-Berlingo	MERCEDES-BENZ Vito (FWD)	PEUGEOT e-Rifter
CITROËN SpaceTourer	MERCEDES-BENZ Vito (RWD)	PEUGEOT Traveller
CITROËN ë-SpaceTourer	MERCEDES-BENZ eVito	PEUGEOT e-Traveller
DACIA Dokker	MERCEDES-BENZ V-Class	RENAULT Kangoo
FIAT Doblò	NISSAN Townstar	RENAULT Trafic
FIAT E-Doblò	NISSAN NV300	TOYOTA Proace City
FIAT Scudo	OPEL Combo Life	TOYOTA Proace City Electric
FIAT E-Scudo	OPEL Combo-e Life	TOYOTA Proace
FORD Connect	OPEL Zafira Life	TOYOTA Proace Electric
FORD Custom	OPEL Zafira-e Life	VOLKSWAGEN Caddy

Please contact Smartfloor for more information and all possibilities.



To be on the safe side

The safety of every wheelchair occupant is our top priority at Smartfloor and is of central importance for all our innovations.

Smartfloor is the leading supplier of system floors and related products for the conversion of accessible vehicles in Europe. This leading position is both a responsibility and a motivation for Smartfloor to ensure that all aspects of its products, which have quality and safety implications, are subject to the strictest of controls. All production work is completed in accordance with the ISO 2001 standard. In addition, all lifts and ramps which the company delivers are TÜV-tested in 20 G front-on vehicle crashes.

All Smartfloor products offer a high level of safety. Vehicle floors equipped with the Smartfloor meet all safety requirements of the stringent EU directives such as UN-ECE R14, R16, R17, ISO 10542 and DIN standard 75078. All surfaces which may present a slip hazard in the vehicle comply with slip resistance class R11. Lifts and electric steps are subjected to thorough EMS tests and then approved by the German Federal Office for Motor Vehicles.

In order to further improve safety and protection for people with mobility restrictions, Smartfloor and its partner AMF-BRUNS have been successfully working in cooperation with competent partners such as TÜV Nord, TÜV Rheinland, BAST, UTAC (France), AIB Vinçotte (Belgium), Status (United Kingdom), Volkswagen, Mercedes Benz, RDW Holland and the German Federal Office for Motor Vehicles.

A major step in the quest for "even more tested safety" has been taken by Smartfloor and AMF-BRUNS with its new in-house accredited test equipment at AMF-BRUNS in Apen, Germany. Together with the Dutch RDW and German TÜV or the British VCA, Smartfloor now tests and examines safety-relevant components, products and retrofitting in house. In future, for example, seat testing, strength testing of built-in vehicle components or wheelchair restraining systems will become routine in our own test centre for all types of vehicles on the market. With up to eight special cylinders the required tension is built up within a matter of milliseconds. In the meantime, other conversion companies are also taking the opportunity to have testing done by Smartfloor.

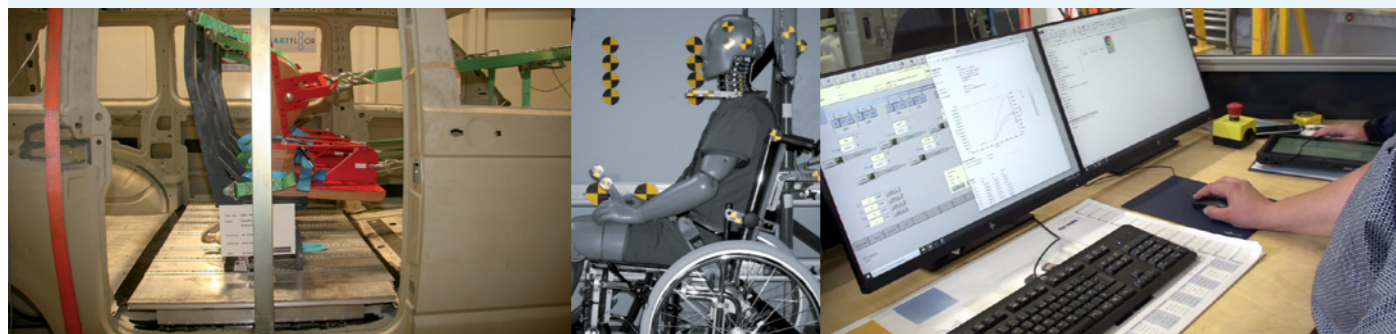

Images:

1. A vehicle body is fixed to the stable test system frame ready for the tension trials.

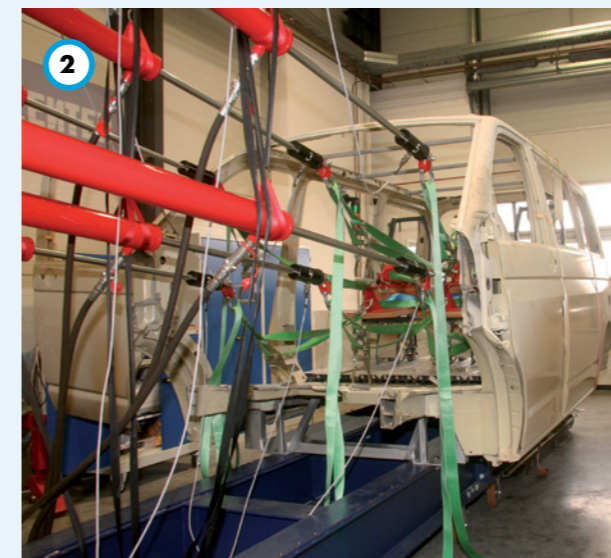

2. Special pulling cylinders ensure that a force equivalent of up to 20 G front-on vehicle crash is built up within milliseconds.



3. This shows a test with 3 M1 seat dummies, aimed at testing Smartfloor's seat fixings, the so-called "Smartlegs" on the Smartfloor system floor.

The following vehicles have been tested by TÜV and Smartfloor with regards to anchorage points. Test certificates and Installation Manuals are available at www.smartfloor.eu.

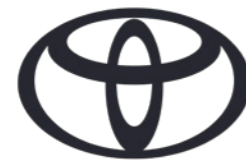

Adhesives	11
Airline rail	9
AMF Bruns Cassette lift	97
AMF Bruns AL1 Solid lift	88
AMF Bruns AL1 Split platform lift	90
AMF Bruns AL1 Panorama lift	92
AMF Wheelchair and Occupant Restraints Protektor	37
Assembly Kits	70
Automatic shoulder belts	61
Basic profiles	8
Side Step	86
Channel ramps	101
Conversion kits for various brands	109
Cover strips	10
Easypull	68
eFutureSafe	75
Electric belts	56
Electric Side Step	81
Euro-Rampe	86
Fixed seatleg & Seatleg	16
Floor covering	76
Floor end strips	10
Floor plans	12
FutureSafe head & back rest	72
Harness belt	61
Millennium leg	16
Mono fitting	62
Mounting brackets	17
Protektor - system Black Series	39
Protektor - system Silver Series	45

Protektor - system Platinum Series	51
Protektor - system Occupant Restraints	59
Ramps	86
Seat legs	16
Shoulder belt	60
Smartfloor Easy XL M1	30
Smartfold seat leg	16
Smartleg	16
Smartleg spacer	16
Smartseat Travel M2/Travel Luxury M2	34
Smartseat Easy M1	22
Smartseat Easy ISOfix M1	24
Smartseat Tip & Fold M1	26
Smartseat Flip-Up M1	28
Smartseat RV M1	32
Spacer profiles	8
Storage boxes	65
Straight rail	8
Stretcher DIN 1789	79
T-bolts	16
Useful products	10
V-Leg Seat legs	18
Vehicle matrix	6, 7
Wheelchair restraint systems	37

VW Transporter

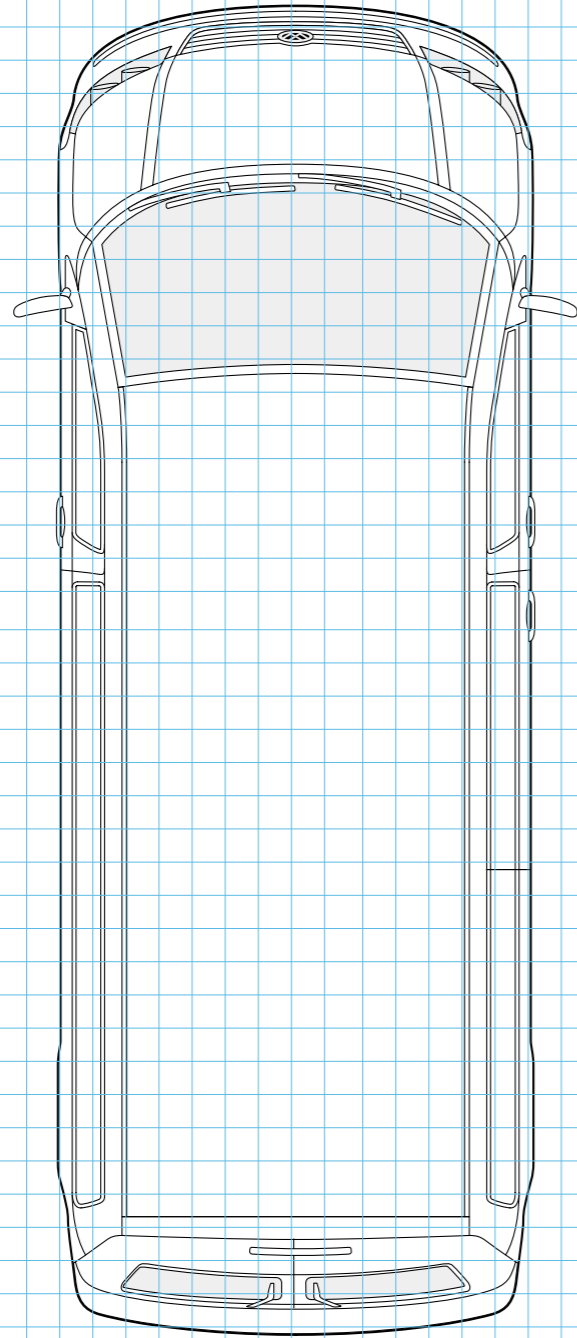

[Blank blue header bar]

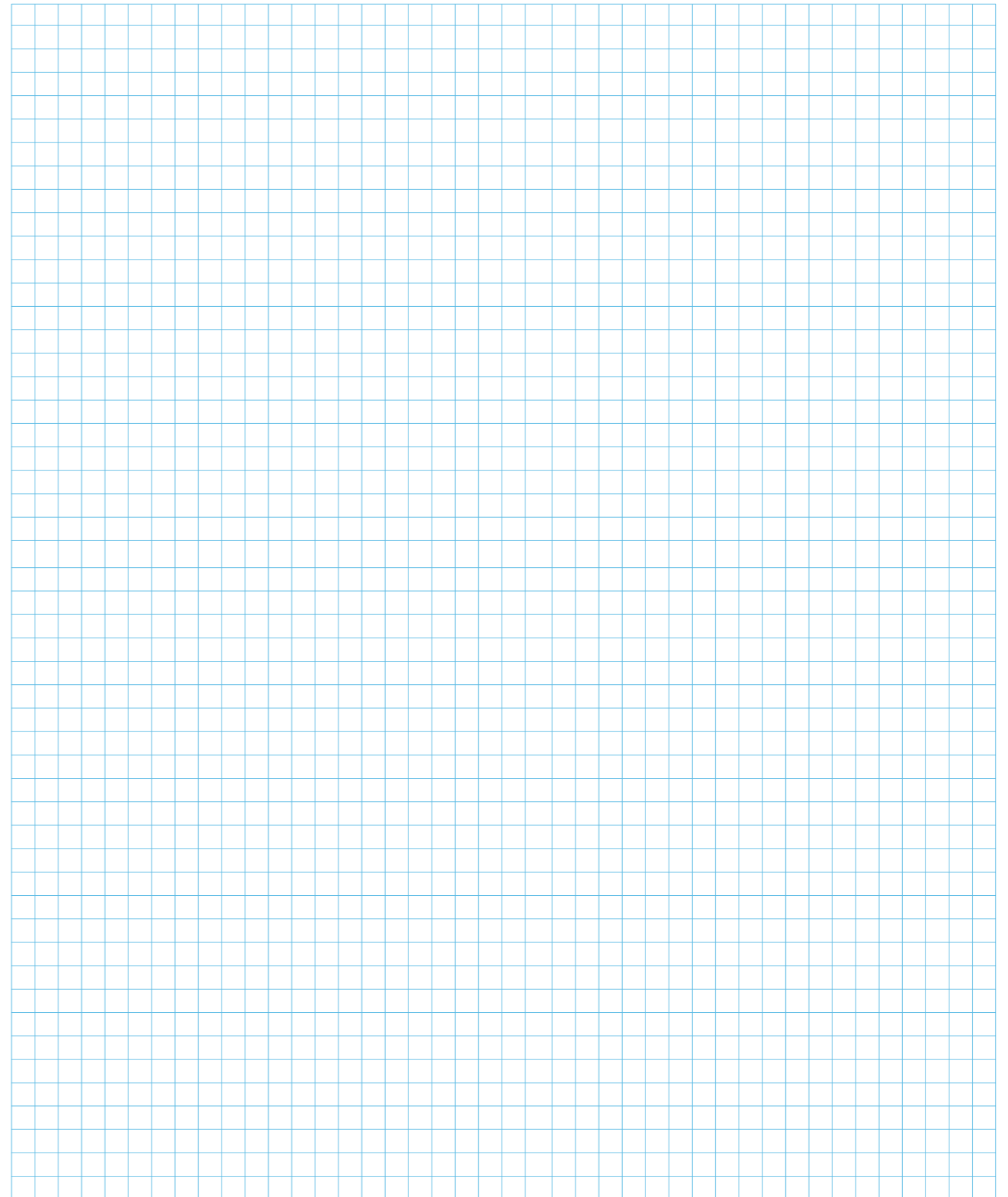

Mercedes Benz Long

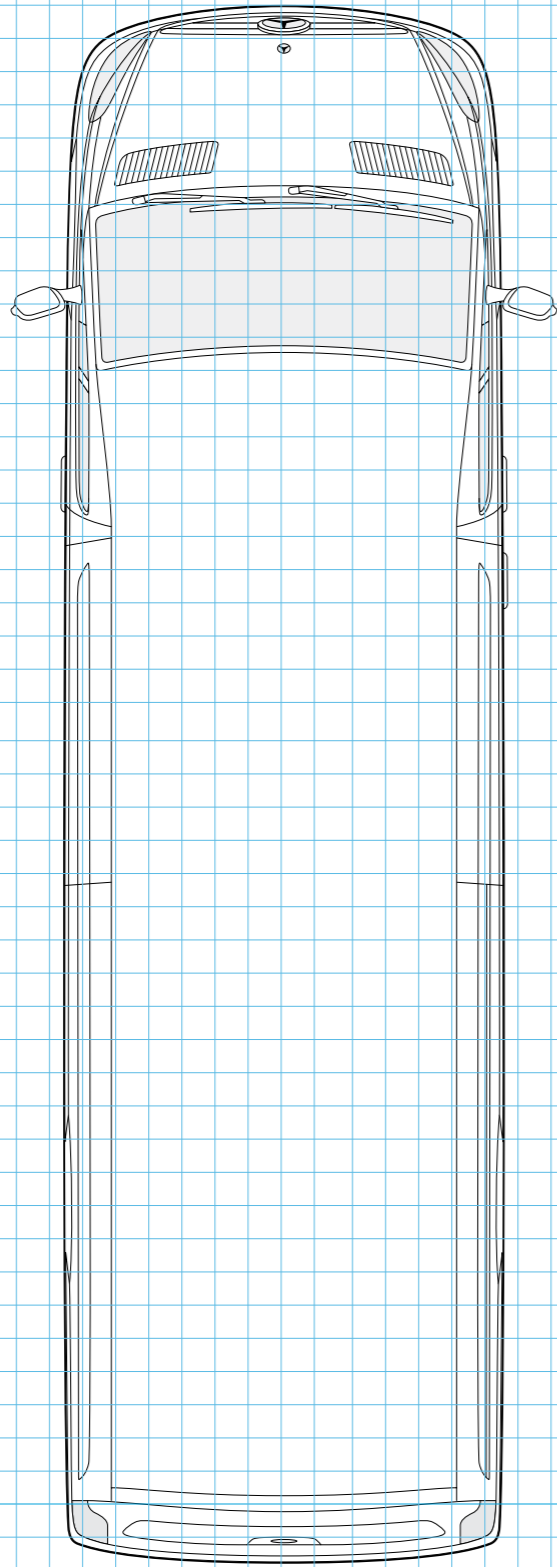

[Blank blue header bar]

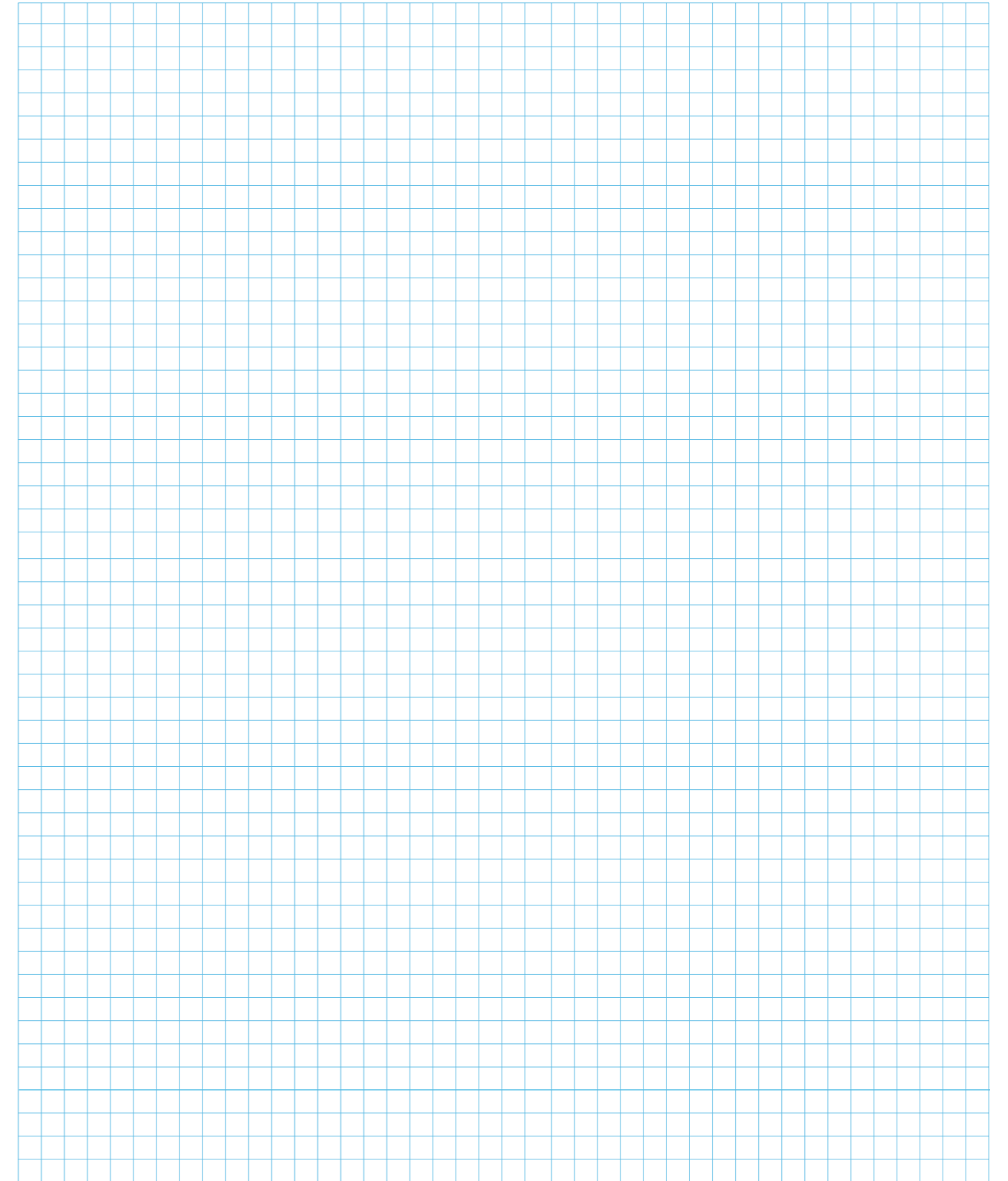

Mercedes Benz Extra Long

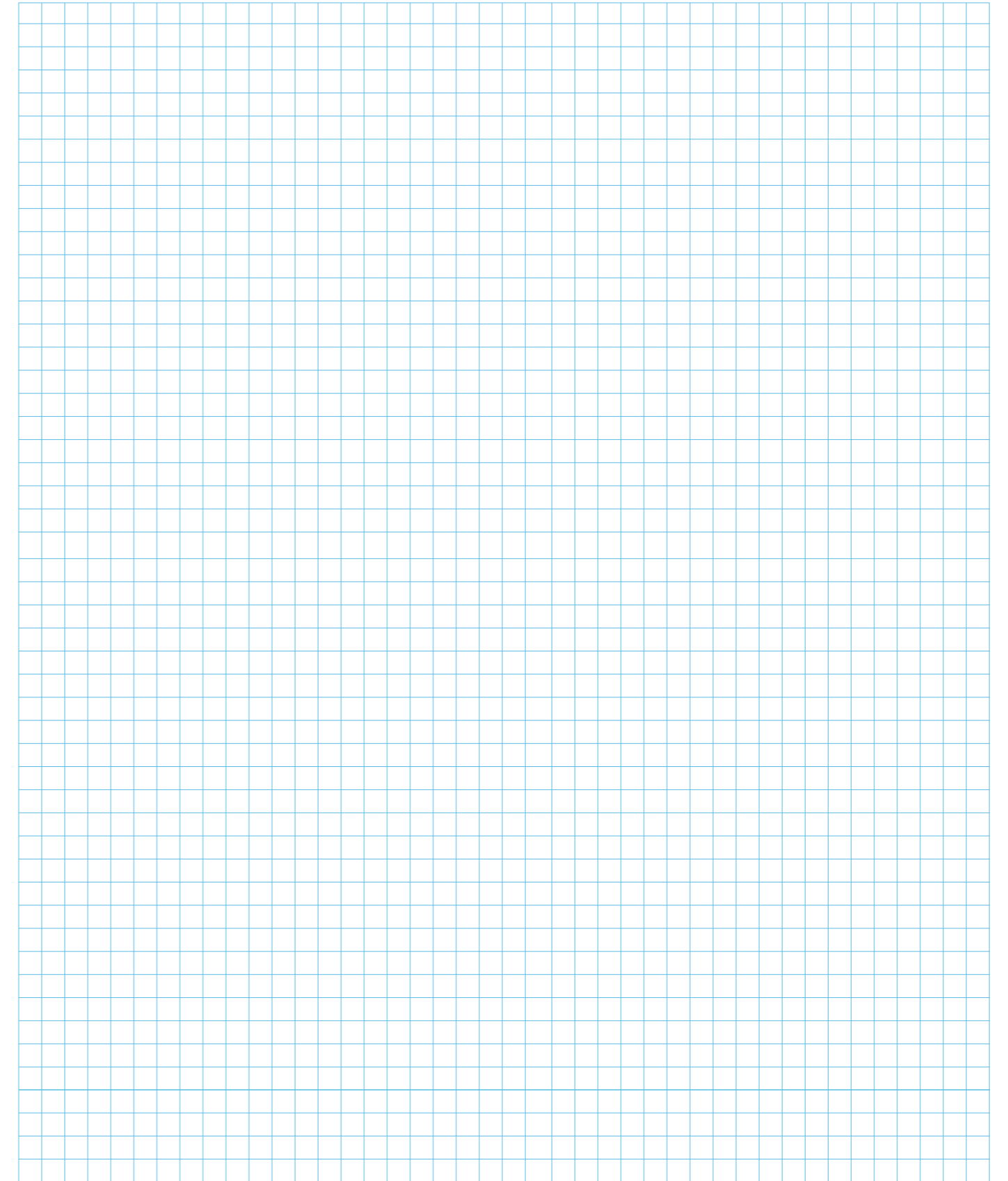
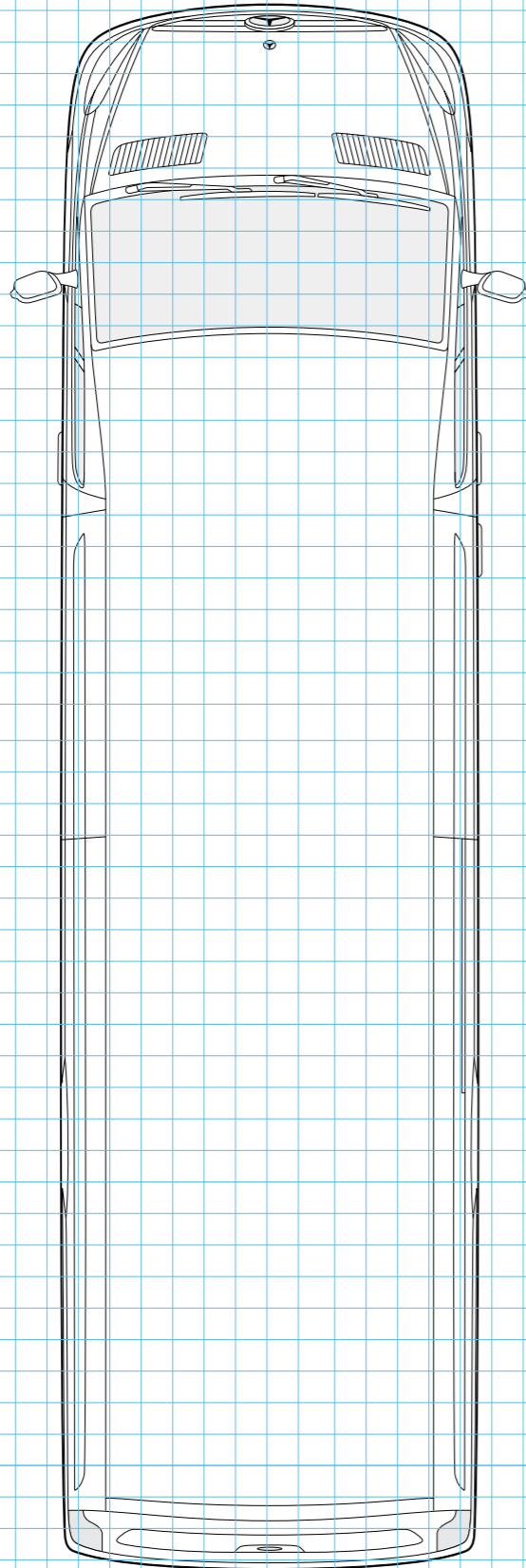



Lined writing area with horizontal blue lines.



Lined writing area with horizontal blue lines.

SMARTFLOOR

Flexibility inside

Netherlands, Belgium and Luxembourg

SMARTFLOOR B.V.
Bedrijvenpark Twente 415
7602 KM Almelo
Nederland
Telefoon : +31 546 45 55 65
www.smartfloor.nl
info@smartfloor.nl

United Kingdom, Ireland

AMF-Bruns UK LTD
Unit 3, Parkway Four
Longbridge Road
Trafford Park
Manchester
M17 1SW
Tel. +44 161 872 7951
www.amf-bruns.com
info@amf-bruns.co.uk

United States of America

AMF-Bruns of America LP
1797 Georgetown Road
Hudson · OH 44236
Phone +1 877 506 3770
www.amfbrunsamerica.com

Germany

AMF-Bruns GmbH & Co. KG
Hauptstraße 101
D-26689 Apen
Postfach 160
D-26689 Apen
Tel. +49 44 89 72 71 01
www.amf-bruns.de
hubmatik@amf-bruns.de

Asia

Smartfloor Seating (Thailand) Co., Ltd.
Moo 1 165/150
T. Sanpapao A. Sansai
Chiang Mai 50210, Thailand
Phone +66 8 2187 0372
www.amf-bruns.asia

South Africa

AMF-Bruns South Africa
Shoprider
92 Jakaranda Street
Unit # 13 Diamond Park
Hennospark · CENTURION
Phone + 27 12 653 1817
www.amf-bruns.co.za



Member of AMF-Bruns group

