







SCALES

ARTICLE #	DESCRIPTION
1 700-19485	Scale Unit/ 272 kg (600 lb) Quick Connect
2 700-19490	Scale Unit/ 272 kg (600 lb) Class III ¹ Quick Connect

¹ Class III scales shall be calibrated by a notified body, prior to put into service.



COMPATIBLE SPREADER BARS

	ARTICLE #	DESCRIPTION	DISINFECTION AGENTS
	700-19420	Carry Bar 2-hook small	
	700-19470 700-19465 (US market only)	Infection Control spreader bar 2-hook	
	700-19415 700-19435 (US market only)	Spreader bar MS2 2-hook	 With vinyl cover  Without vinyl cover
	700-19430	Carry bar 4-hook	
	700-19475	DPS flat Manual	

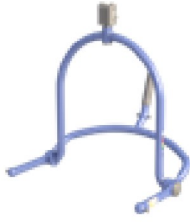
**700-19480**

DPS manual open medium

**700-19350**

Spreader bar Powered DPS (PDPS) 4-point clip
open medium Quick Connect
(Not compatible with WCS)

**700-19355**

Powered Large DPS
(Not compatible with WCS)

**700-15695**

Stretcher 272 kg (600 lb)

**700-05382**

Morgue spreader bar
(Standard bands included)

**700-05387**

Morgue spreader bar
(Long bands included)



SPACE REQUIREMENTS

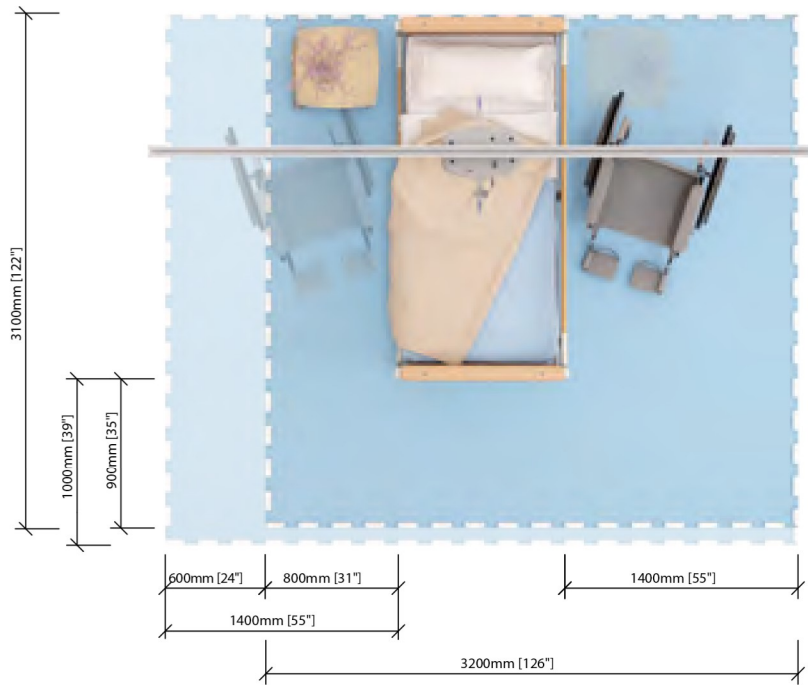

For more information about Space requirement, consult the Arjo Guide for Architects and Planners website.



- Blue area shows the minimum working area required for the staff to be able to use the floor lifter in an ergonomic way from one side.
- Light blue area shows required extension of working area to facilitate activities from either side to provide adequate access for the patient, floor lifter and assisting carer.

PRODUCT DIMENSIONS

Maxi Sky 2 & Maxi Sky 2 Infection Control

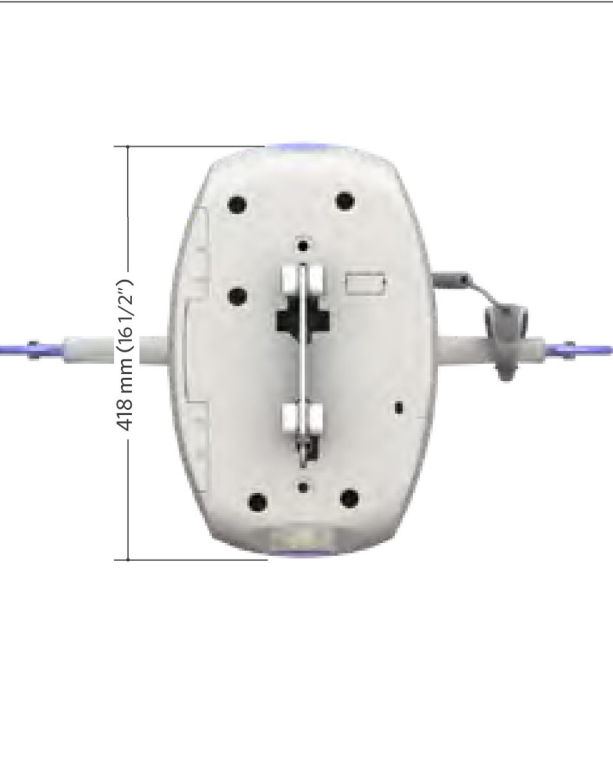

2-point spreader bar (Small)

700-19420

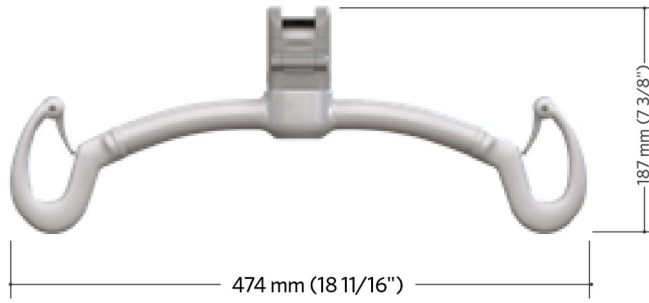

Weight: 2,5 kg (5,5 lb)

Infection Control 2-point spreader bar

700-19470

700-19465 (US market only)



Weight: 1,5 kg (3,3 lb)

2-point spreader bar

700-19415

700-19435 (US market only)

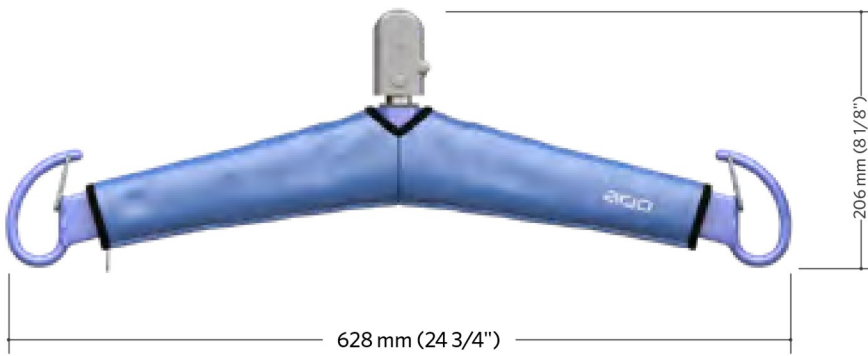

Weight: 1,5 kg (3,3 lb)

4-point spreader bar

700-19430

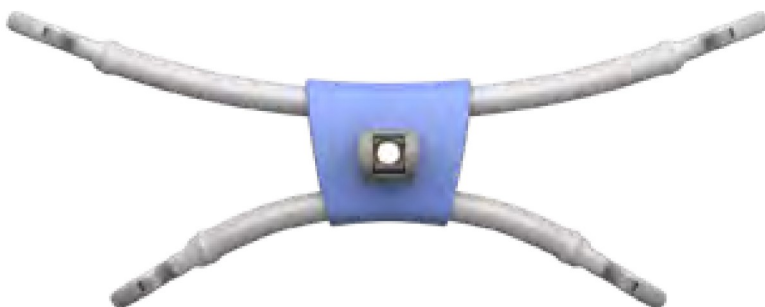
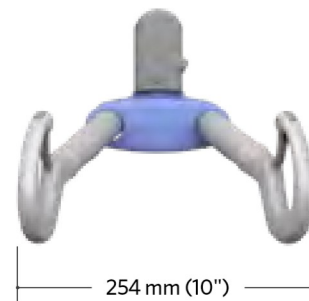
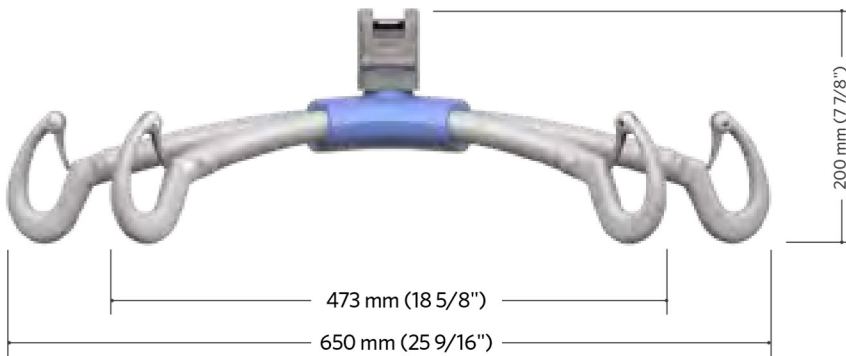

Weight: 4,4 kg (9,7 lb)

Flat DPS
700-19475

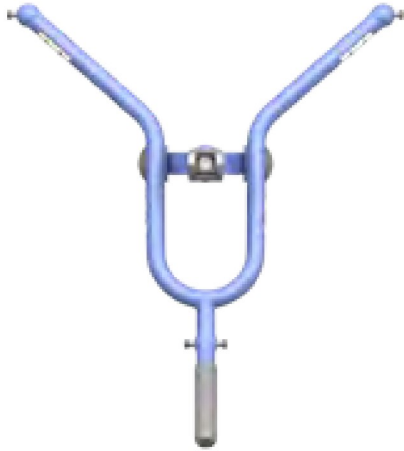
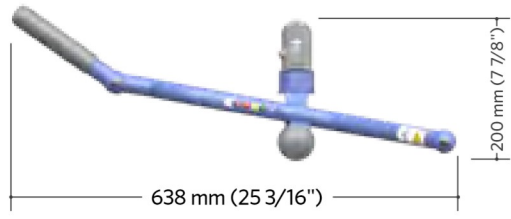
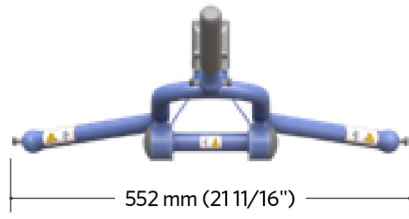

Weight: 3,4 kg (7,5 lb)

Powered DPS (Medium)
700-19350

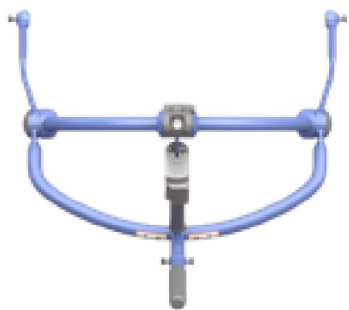
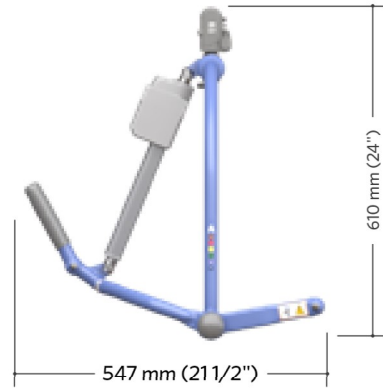

Weight: 7,9 kg (17,4 lb)

Powered DPS (Large)

700-19355

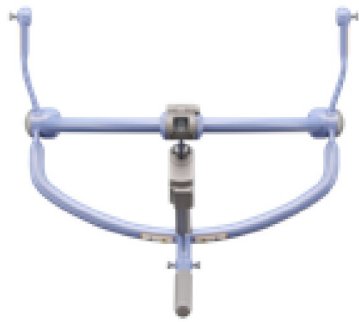
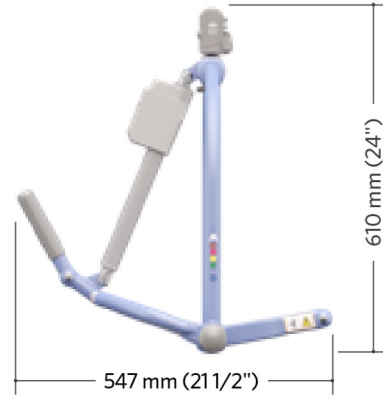
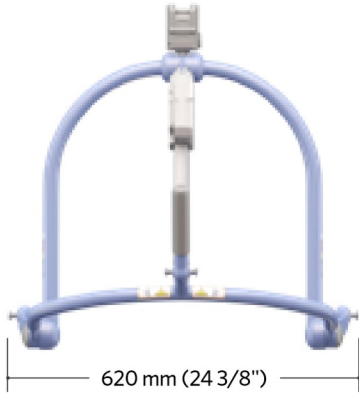

Weight: 7,9 kg (17,4 lb)

DPS manual open (Medium)

700-19480

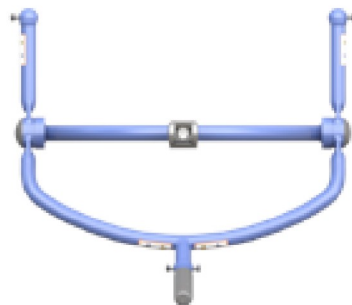
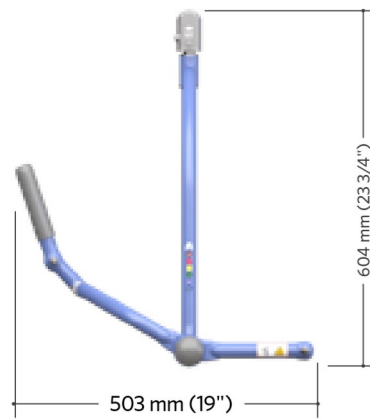

Weight: 5,7 kg (12,5 lb)

Morgue stretcher bar
700.05382 & 700.05387

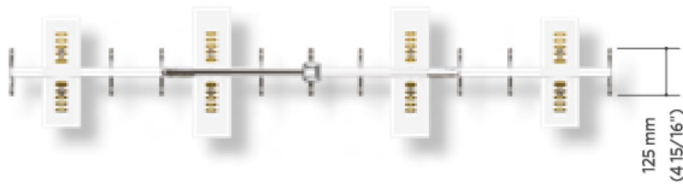
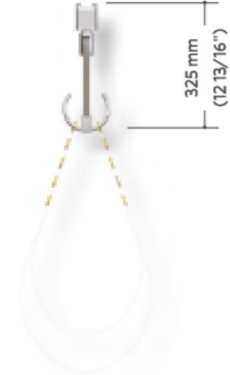
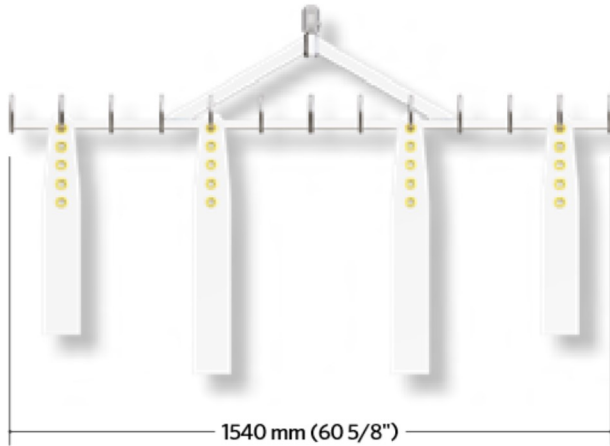

Dimension:
Standard bands kit (#700.05382):
2x 1194mm (47") & 2x 1448 (57")
Long bands kit (#700.05387):
2x 1194mm (47") & 2x 1829mm (72")
Weight (Stretcher frame only):
8,9 kg (19,5 lb)

Stretcher frame
700-15695

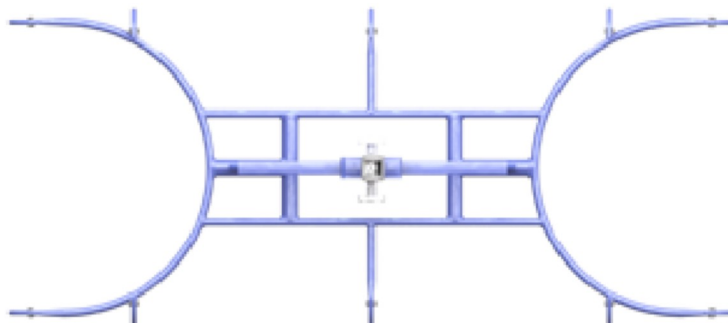
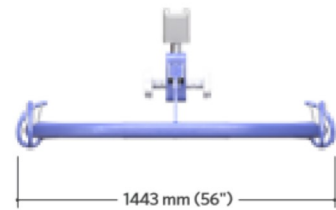
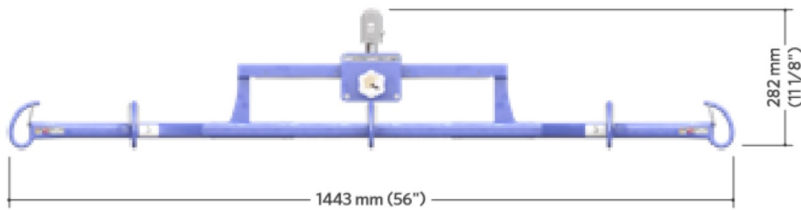

Weight: 10 kg (22,2 lb)