

TiLite

# Options



permobil

## Front wheels

- 1 **FW24** 3"x1.5" LiteSpeed Billet Aluminum Wheel w/Soft Roll Tire
  - Silver Hub OR Black Hub
- 2 **FW14** 4"x.75" Plastic Wheel w/Poly Tire
- 3 **FW3** 4"x.75" Light-Up Micro Caster
- 4 **FW27** 4"x1.5" LiteSpeed Billet Aluminum Wheel w/Soft Roll Tire
  - Silver Hub OR Black Hub
- 5 **FW6** 5"x1" Plastic Wheel w/Poly Tire
- 6 **FW30** 5"x1.5" LiteSpeed Billet Aluminum Wheel w/Soft Roll Tire
  - Silver Hub OR Black Hub
- 7 **FW28** 5"x1.5" LiteSpeed Plastic Wheel w/Soft Roll Tire
- 8 **FW33** 6"x1.5" LiteSpeed Billet Aluminum Wheel w/Soft Roll Tire
  - Silver Hub OR Black Hub

### Options not shown

**FW26** 4"x1.5" LiteSpeed Plastic Wheel w/Soft Roll Tire

**FW9** 6"x1" Plastic Wheel w/Poly Tire

**FW32** 6"x1.5" LiteSpeed Plastic Wheel w/Soft Roll Tire



## Front forks

- 1 **GL1** Glide™ Suspension Fork
- 2 **FK1** TiLite Standard Fork
- 3 **FK2** TiLite Slipstream Single-Sided Fork



## Axles

- 1 **AXL1** Stainless Quick Release
- 2 **AXL3** Quad Release

### Options not shown

**AXL2** Titanium Quick Release

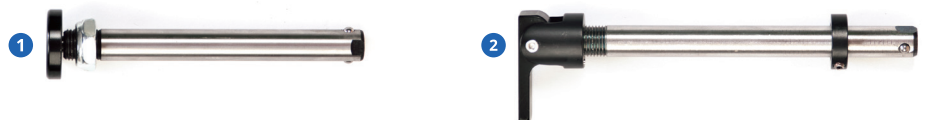





## Rear wheels

Rear wheels by Out-Front®

### 1 RW14 SHADOW

Performance rear wheels

### 2 RW16 Spinergy Carbon Blade

### 3 RW8 Spinergy LX

### 4 RW7 Spinergy SPOX

### 5 RW17 X-Core Mag



Available in 20"(451), 22"(501), 24"(540), 25"(559) and 26"(590) sizes.



Available in 24"(540) and 25"(559) sizes.



Available in 22"(501), 24"(540), 25"(559) and 26"(590) sizes.



Available in 22"(501), 24"(540), 25"(559) and 26"(590) sizes.



Available in 20"(451), 22"(501) and 24"(540) sizes.

Available spoke colors



\*Purple only available in size 22"

Available ano colors



\*Spinergy Design Lab

Available spoke colors





## Rear tires

### Pneumatic rear tires

- 1 **RTR1** Treaded 22"(501), 24"(540) & 26"(590)
- 2 **RTR31** MBL SpeedLite 20"(451), 22"(501), 24"(540), 25"(559) & 26"(590)
- 3 **RTR8** Schwalbe® Marathon Plus Evolution 24"(540), 25"(559) & 26"(590)
- 4 **RTR30** Primo Sentinel 20"(451), 22"(501) & 24"(540)
- 5 **RTR9** Schwalbe® Slick 24"(540) & 25"(559)
- 6 **RTR24** Primo C-763 Knobby Tire



1

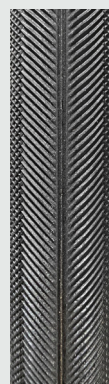

2



3

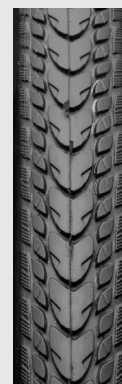

4

### Solid rear tires

- 7 **RTR22** Primo Express 20"(451), 22"(501), 24"(540) & 25"(559)
- 8 **RTR23** Primo Active 24"(540) & 25"(559)



5



6



7

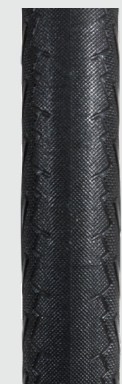

8



# Handrims

- 1 **RIM1** Aluminum – Silver Anodized
- 2 **RIM21** Aluminum – Black Anodized
- 3 **RIM12** Titanium – Satin Finish
- 4 **RIM14** The Natural-Fit® Standard Grip  
*Original, Larger Profile*
- 5 **RIM18** The Natural-Fit® LT Super Grip  
*Reduced Weight, Smaller Profile*
- 6 **RIM10** The Surge  
*All-In-One Oval with Gription™ Strip, Larger Profile*
- 7 **RIM11** The Surge LT  
*All-In-One Oval with Gription™ Strip, Smaller Profile*
- 8 **RIM20** Q-Grip  
*Exclusive High-Friction, Anti-Slip Coating*

## Options not shown

- RIM15** The Natural-Fit®  
*With Super Grip Original, Larger Profile*
- RIM16** The Natural-Fit®  
*Without Thumb Grip Original, Larger Profile*
- RIM17** The Natural-Fit® LT Standard Grip  
*Reduced Weight, Smaller Profile*
- RIM19** The Natural-Fit® LT  
*Without Thumb Grip Reduced Weight, Smaller Profile*
- RIM5** Plastic Coated – Black



## Back Upholstery

- 1 **BUP2** Velcro Adjustable
- 2 **BUP3** Tension Adjustable by Straps
- 3 **BUP5** AIR Breathable Upholstery
- 4 **UPC3** Ultrasuede Backrest Stripe

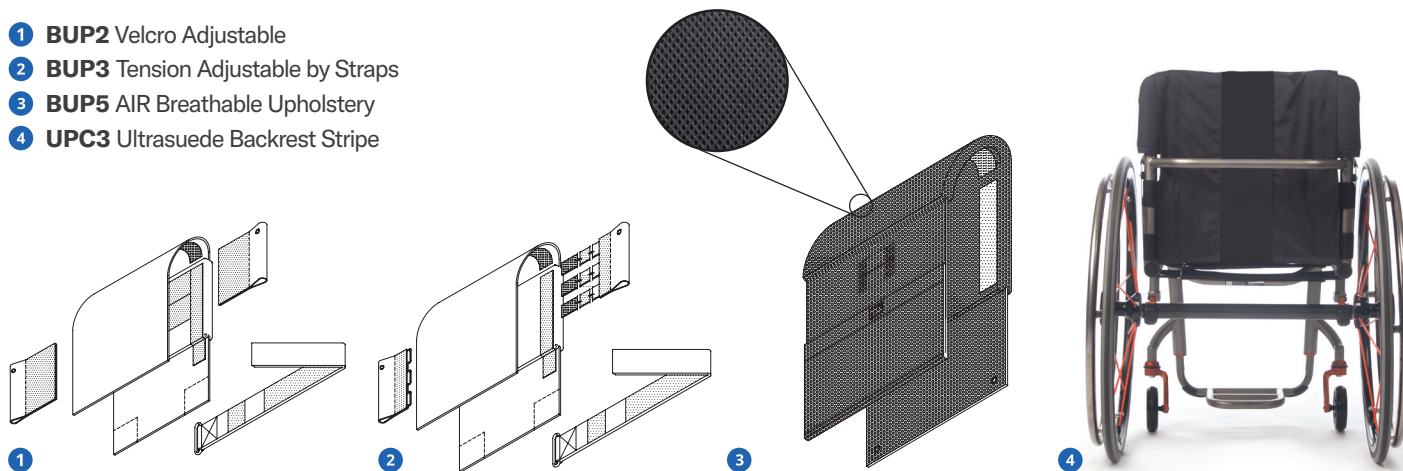

## Seat Upholstery

- 1 **SUP1** Tension Adjustable Bolt On
- 2 **SUP2** Tension Adjustable by Straps
- 3 **SUP8** Aluminum Solid Seat
- 4 **SUP4** Tension Adjustable for Folding Chairs

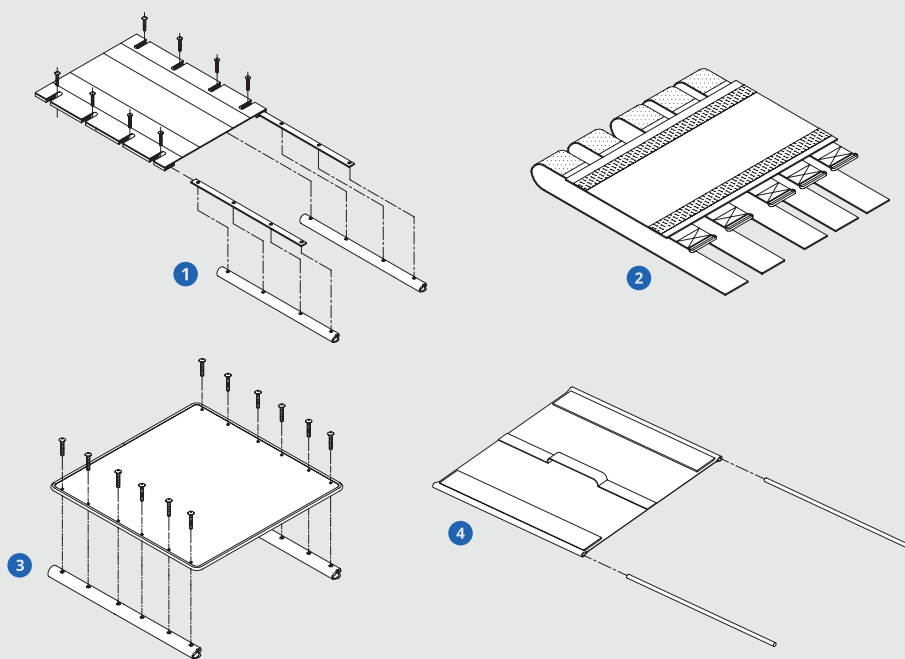

## Wheel locks

Composite wheel locks by Out-Front®

- 1 **WLK7** Push OR **WLK8** Pull (shown)
- 2 **WLK11** MBL Composite Scissor
- 3 **WLK10** Extension Handles for Push OR Pull

Additional wheel locks

- 4 **WLK3** Uni-Lock All-in-One Push OR Pull

Options not shown

- WLK4** Extension Handles for Uni-Lock
- WLK15** Grade Aids Push to Lock







## Side guards

- 1 **SDG7** Carbon Fiber Rigid Removable
- 2 **SDG8** Carbon Fiber Quad Removable w/Hole
- 3 **SDG9** Carbon Fiber Fold Down Rigid
- 4 **SDG12** Carbon Fiber Fendered Removable
- 5 **SDG6** Aluminum Fendered Adjustable

### Options not shown

- SDG2** Aluminum Rigid Removable
- SDG3** Aluminum Quad Removable w/Hole
- SDG4** Aluminum Fold Down Rigid

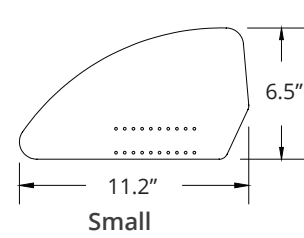
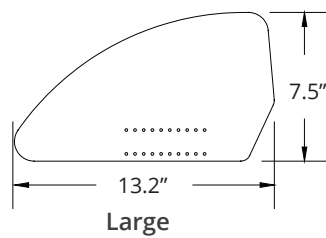
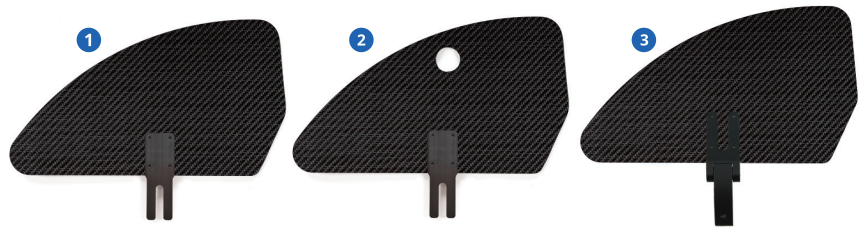





## Armrests

- 1 **ARM1** Swing-Away Tubular
- 2 **ARM4** Swing-Away - Flip Back Tubular
- 3 **ARM2** Removable Height Adjustable Desk Arm with Rigid Side Guard
- 4 **ARM3** Removable Height Adjustable Desk Arm with Rigid Side Guard and Transfer Loop

Options not shown

**ARM5** Covered in Black Ultrasuede





## Footrests

### Rigid chair footrests

- 1 **FTR3** Angle Adjustable Footrest
- 2 **FTR1** Titanium Footrest w/Flat ABS Cover
- 3 **FTR2** Titanium Open Loop Footrest
- 4 **FTR12** Titanium Flip-Back Footrest
- 5 **FTR27** Flip-Back Depth & Angle Adjustable High Mount Footrest

### Folding chair footrests

- 6 **FTR5** Flip-Up Footrest (also available on rigid chairs through CMD 40)
- 7 **FTR6** 1-Piece Flip-Up Footrest (CMD Creative Mobility Division)

### Options not shown

- FTR7** 1-Piece, Over-Center Folding Footrest
- FTR9** Depth Adjustable Flip-Up
- FTR11** Angle Adjustable Flip-Up
- FTR10** Depth and Angle Adjustable Flip-Up
- CMD40** Custom Flip Up Footplates for T-series

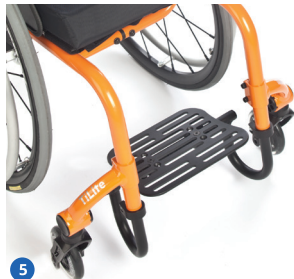
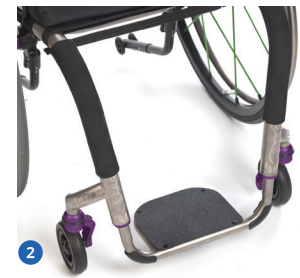

NOTE: For a complete list of Footrest options see TiLite's order forms.

## Anti-tips

- 1 **TIP2** User Friendly Rear Flip-up
- 2 **TIP5** Center Mount Swivel Caster (TWIST, available on other chairs through CMD)

### Options not shown

- TIP1** Rear Aluminum - Black
- TIP4** Tip Assist
- TIP6** Center Mount Non-Swivel Caster

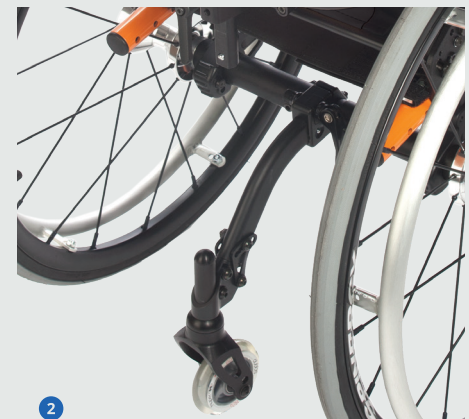
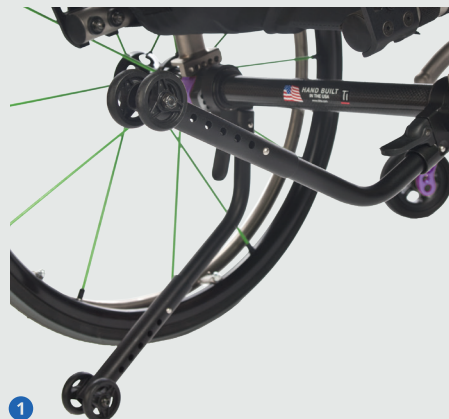

## Push handles

- 1 **SB6** Integrated Push Handles
- 2 **SB7** Integrated Fold Down Push Handles
- 3 **SB8** Bolt On Push Handles
- 4 **SB20** Bolt On Center Mount Height-Adjustable Push Handle  
(a TWIST style backrest is required)

### Options not shown

- SB9** Bolt On Height-Adjustable Push Handles
- SB21** TWIST Stroller Handle



## Additional options

- 1 **SB5** Carbon Fiber TiShaft™ Back Release Bar - Also available in **SB3** Aluminum
- 2 **MPCT2** Neoprene Impact Guards with Ultrasuede Stripe
- 3 **PCH3** Permobil Medical Necessities Seat Pouch, **BCK3** Permobil Medical Necessities Backpack & **PCH4** Bodypoint® Mobility Bag
- 4 **XAFP1** 4" Military Logo Patches
- 5 **LUG1** Luggage Carriers
- 6 **CBR11** Zero Play Aluminum Camber Plugs, **CBR12** Adjustable Rear Wheel Spacing Camber Plugs
- 7 **SB2** & **SB15** Rounded Titanium Rigdizer Bar - Available on rigid chairs (not available on the TWIST)

### Options not shown

**XRSL1** Residual limb support

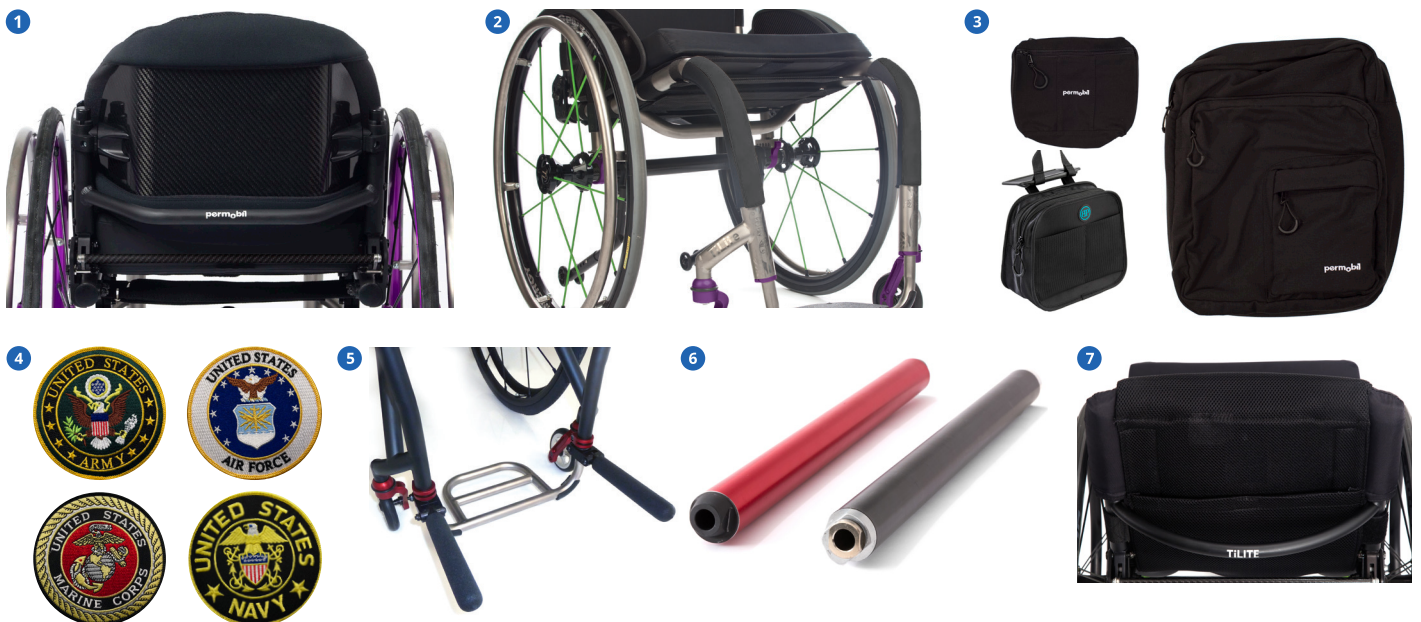

NOTE: Not all options are available on all models. See order forms for availability and pricing. Prices, standard features, options and accessories are subject to change without notice.





## Tattoo options

- 1 Mosaic
- 2 Flower garden
- 3 Need for speed



1



2



3

## Frame colors

### High gloss paint



TiLite red Neon pink High gloss black

### Metallic paint



Tangerine metallic Acid green Metallic Ocean blue metallic

### Pearlescent paint

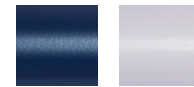

Midnight blue pearl White pearl

### Matte paint

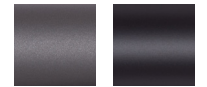

Titanium grey Black lava

### Candy paint



Ruby red Azure blue Electric plum

### Matte textured paint

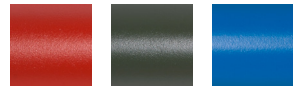

Flame orange OD green Hyper blue

### Natural Titanium



Satin Polished (CMD 87)

## Component colors

### Anodized



Red Orange Blue Purple Green Gold Black

# Creative Mobility Division (CMD)

TiLite understands that everyone has different postural and mobility needs, and while our order forms meet the needs of most users, sometimes you need individual solutions.

Through CMD, customers are able to work with our team of engineers, customer experience, and production to come up with creative solutions to their unique needs.



Scan to view full CMD catalogue



CMD 08 - custom front frame width for more room for leg propulsion and ease of use

Shorter frame height for easier access to the ground for better propulsion

CMD 40 - Custom flip-up footplates on rigid frames

## TiFit for foot-propelling customers

CMD 40 and CMD 08 allow users who foot-propel to have an optimally configured, rigid, ultra-lightweight manual wheelchair for the best possible functional outcome. Pair this setup with a SmartDrive to easily and independently navigate your environment!

© 2023 Permobil. All rights reserved. Trademarks are identified by symbols ™ and ®. TiLite, the TiLite logo, Ti, TiFit, and The Titanium Experts are registered trademarks of TiLite, LLC. Bodypoint® is a registered trademark of Bodypoint Inc. The Natural-Fit® is a registered trademark of Three Rivers Holdings, LLC.