

 **Bodypoint**[®]
STRENGTHEN YOUR POSITION





OUR MISSION:

TO CREATE EXCEPTIONAL PRODUCTS THAT ENABLE
WHEELCHAIR USERS TO IMPROVE THEIR LIVES



WHAT WE DO MATTERS

Wheelchair positioning is all we do at Bodypoint, for thousands of very important reasons: our users. Every device we make, no matter how simple, has the potential to positively affect someone's mobility and independence. For more than 30 years, we've created better connections between people and wheelchairs, manufacturing postural support devices of the highest quality in our factory in Seattle, Washington USA.

THE BODYPOINT DIFFERENCE

We design products with one ultimate goal in mind: to solve problems within the seating system. We believe in integrating the user and their wheelchair, a principle embodied in our designs. Bodypoint products feature anatomically-contoured shapes for ideal fit and premium materials made to our exacting specifications. If it's Bodypoint, you can count on it. Our flexible postural supports are machine-washable, shrink-resistant, and won't fall apart. Our attachment hardware sets the industry standard for strength. However, there's one thing we love more than making great products... Creating solutions.

BEST IN CLASS QUALITY

When it comes to safety and performance, we don't take chances. Bodypoint is certified to ISO9001 for its Quality Management System and tests its products to the latest international standards. Our commitment to our customers doesn't end there-for more than 20 years, we have collaborated with other industry leaders around the world to develop new and better wheelchair standards which help ensure users and professionals get the performance they deserve.

Visit www.bodypoint.com/standards for more information.



AVAILABLE WORLDWIDE

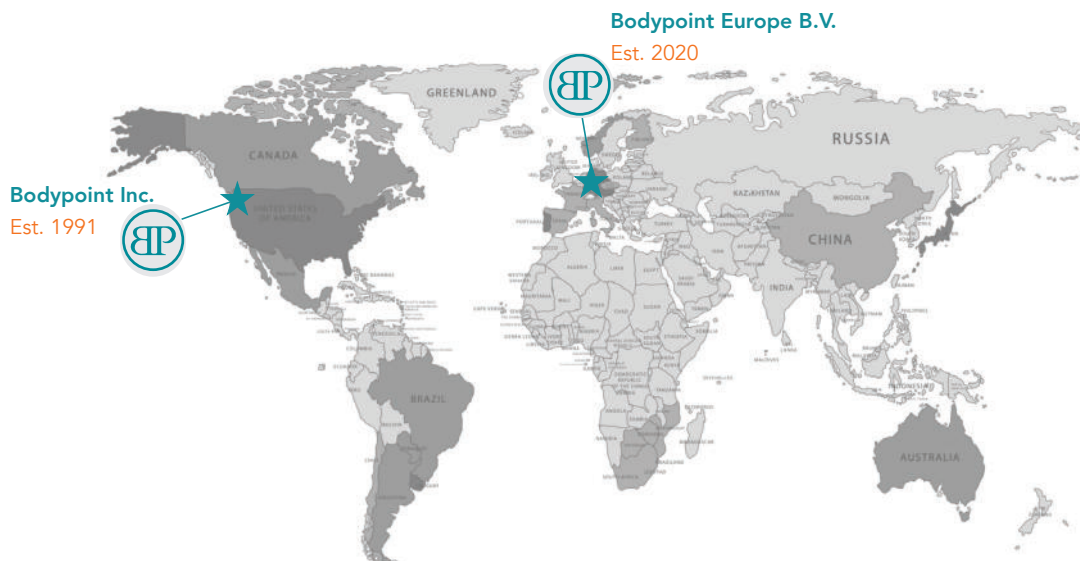



PELVIC POSITIONING

Two & Four-Point Belts	07
Evoflex® Hip Belt	08
Choose a Hip Belt	10
How to Order	11
Buckles & Options	12
Accessories	13



UPPER BODY SUPPORT

Four-Point Harness	16
MD Series™ Harnesses	16
Style Options	17
Harness Strap Guides	18
Two-Point Harnesses	19



LOWER BODY SUPPORT

Ankle Huggers®	21
Calf Supports	22
.....	
Mobility Bag	24
Elastic Mobility Straps	25

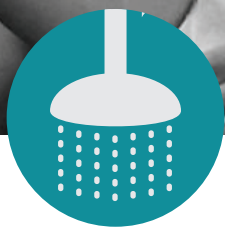
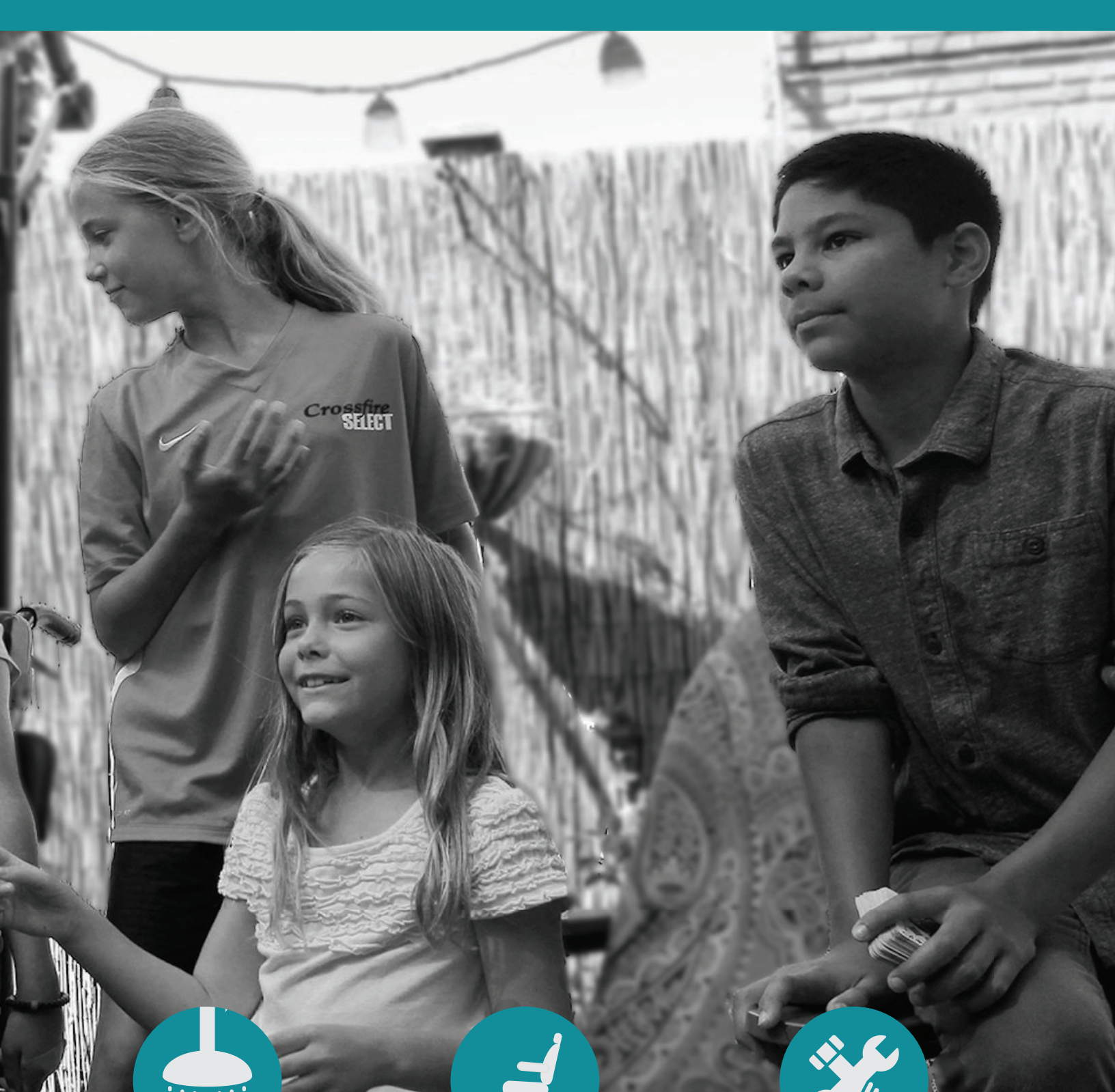

BATH AND SHOWER POSITIONING

Aeromesh® Bath Belts	27
Shower Chair Calf Support	27



ARM SUPPORTS & POWER WHEELCHAIR CONTROLS

Modular Arm Supports	28
Flex-Shaft Joystick Handles	31
Tri-Lock™ Rotating Shaft	33
Midline Arm Style	33
Joystick Mounting Kits	34



TECHNICAL INFORMATION

Belt Measuring	36
End-Fittings	38
Mounting Hardware	39
Harness Options	39
Other Hardware	40



HIP BELTS FROM BODYPOINT

For hip belts, the total width is measured over the hips of the end-user's lap. This measurement corresponds to the length of the belt's pressure-relieving padding. Bodypoint hip belts have a part number indicating the padding length in centimeters. We recommend choosing a larger padding length if the user is between sizes or on the upper edge. As an example, the belt's total padding length in centimeters is "46" as part of the part number below.

PART NUMBER ON BODYPOINT'S HIP BELTS

The length of the padding is stated in centimeters and is stated in the part number.

The sizes Small, Medium and Large indicate the width of the strap.

S 25 mm (1") **M** 38 mm (1.5") **L** 50 mm (2")



HOW A PART NUMBER IS BUILT



* HB Hip Belt * 0 Push Button

SIZE SPECIFICATION :

Ex. **HB205-M46-B1**

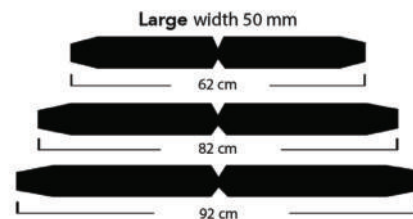
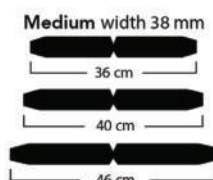
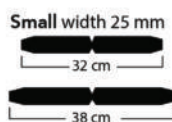

HIP BELTS & ADVANCED POSITIONING



Two-Point Padded Hip Belt

This simple-to-use belt with two points of attachment was designed to combine all-day user comfort with effective pelvic support in a variety of mounting positions.



Four-Point Padded Hip Belt

Our Four-Point Padded Hip Belt has the same features as our Two-Point Belt, but attaches to the wheelchair in four places to ensure that the pelvis does not move from an aligned, stable position and stays securely against the seat and back supports.



Sub-ASIS Compatible Belts

Similar features to our regular Padded Hip Belts, but with a special lining for attachment of adjustable Sub-ASIS Pads (sold separately). The attachable pads provide focused pressure for improved control of obliquity and rotation. Available in two-point and four-point styles.



Sub-ASIS Pads

Attach these gel-filled, 3D-contoured pads to the inside of Sub-ASIS Compatible or Evoflex belts with hook-and-loop. Easy to reposition for optimal fit. Sold in pairs.

WHAT MAKES THE BELT UNIQUE

There is a seamless transition from the creep-resistant webbing to the contoured pads, made with premium-grade foam that won't flatten out with use. Rounded CORDURA edge binding ensures even pressure distribution. Sewing techniques and materials are selected for maximum grime resistance, but these belts can also be machine washed.





Patented, dual-zone elasticity enhances comfort by allowing moderate shoulder movement without reducing support at the chest. Ideal for helping to manage high tone.

EVOFLEX® HIP BELT

The Evoflex is the first two-point pelvic support belt with rigid straps that keep the belt from falling down. This stops the belt from getting caught in the wheels, side guard, or armrest, which many users around the world appreciate.

With excellent stability, the Evoflex is ideal for any user who wants easy access to their positioning belt. It is simple to engage and disengage, and can be easily folded out of the way when it is not needed.

The Evoflex has multiple buckle options and uses the center-pull tightening function. The attachment method varies depending on the wheelchair.

The foam padding is close-celled and is ergonomically shaped to fit body contours. The stiffened straps have smooth edges for improved comfort and a tighter fit.

To size correctly: measure the entire length over the hips where the user needs the padded surface. Choose the longest padding length possible. This ensures good distribution of pressure on a larger contact surface which, in addition to health benefits, is much more comfortable for the user.

Evoflex® Belt Extender

Made of thick, durable composite, the Evoflex Belt Extender maintains the stiffness of the Evoflex while lengthening the belt up to 12.5 cm (5") per side. This is a perfect solution for mounting to wheelchairs with thicker cushions, deeply-contoured seating, or distant mounting points.

Smart locking pins add a second connection point with the belt, preventing unwanted pivoting.



Alternately, use the reverse side of the Belt Extender without the locking pin to allow pivoting around obstacles.

The Belt Extender can be used with all sizes and can be cut to the desired length using a saw or bent using heat as needed. Fasteners included.



EBE100 Evoflex Belt Extender

The Evoflex two-point belt can be mounted at a desired angle and stays in position. The reinforced sides prevent twisting and allow for easy opening.

The patented, rigid sides prevent the belt from falling into the wheels, sideguards, or armrest.

Slim, tapered strap design improves stability by allowing a tighter fit.

CHOOSE A HIP BELT IN FIVE STEPS

1 SELECT STYLE

Non-Padded



Padded



With Fabric for Sub-ASIS Pad



2 SELECT TWO OR FOUR ATTACHMENT POINTS

Two-Point Hip Belt

Hip belts with two attachment points on the chair are the most common selection.



Four-Point Hip Belt

Hip belts with four attachment points are most appropriate when the user has a tendency to move a lot or has high tone.



3 SELECT BUCKLE TYPE



Push Button

Smooth, rounded corners prevent snagging. Cover is removable for cleaning or replacing with reduced/no-access cover.



Side-Release Buckle

Lightweight, crush-resistant buckle that prevents accidental release but requires strong hand function.



Rehab Latch™

Provides easy opening for those with limited hand function.



Small Push-Button

Secure option for pediatric use or when less-bulky buckle is desired. Security cover optional. *(See Page 12 for Details)*



Swivel Buckle

Smooth, flat design that allows for dynamic movement and equalizes tension. Requires moderate force to release.



DuraLatch™ Buckle

Strong, lightweight, and discreet, with a release mechanism that accommodates all levels of hand function. *(Essentials Line Only)*

Please note that not all buckles are available in all sizes.

4 SELECT PULL STYLE



Center-Pull Hip Belt

Suitable for a wide range of users, especially those with posterior pelvic tilt. Available in the widest variety of sizes and buckle styles.



Dual-Pull Hip Belt

More adjustable to accommodate clothing and weight changes. Available with Side-Release Buckle only.

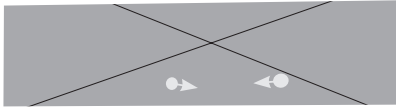

Rear-Pull Hip Belt

Works well for high muscle tone and pelvic rotation. Position and secure one side of the pelvis before the other.

5 SELECT END-FITTINGS



-B1

Flat-Mount

Versatile, lowest profile.



-B2

Cinch-Mount™

Allows quick, easy, and precise adjustments to strap length for changes in weight and clothing.



-B5

Plastic Flat-Mount

Lightweight, high-strength plastic with embedded metal washer.

(Essentials Line Only)

HOW TO ORDER A HIP BELT



1. BELT STYLE

Non-padded, padded,
hook-and-loop,
Evoflex

2. ATTACHMENT

Two or four points

3. BUCKLE TYPE

See page 10

4. PULL STYLE

See above

5. END-FITTINGS

See above

**COMPLETE
PART
NUMBER**

ADDITIONAL HIP BELT OPTIONS



Non-Padded Hip Belt

A basic belt with webbing, strong yet flexible enough for easy tightening. Available in center-pull only. For more comfortable all-day use or more effective postural support, consider a padded hip belt instead. [\(See page 37 for part numbers and more information.\)](#)



Quad Belt

A non-padded belt especially designed for users with minimal hand function. A stiffer and thumb socket make the belt easier to grasp and manipulate. It also features the Bodypoint Rehab Latch buckle, which requires minimal force to open. Center-pull, size large only.

NB225L-T

(Select end-fitting A1, A2, B1, or B2.)



Essentials Belts

The Essentials belts are available in both two- and four-point styles. Choose from side-release buckle or the patented DuraLatch buckle.



The value-engineered line is available in limited sizes and in select markets only.

BUCKLE COVERS

REPLACEMENT COVERS FOR PUSH-BUTTON BUCKLES ON BODYPOINT HIP BELTS

Standard Push-Button Buckle Replacement Cover



Replaces standard cover on Bodypoint Push-Button Buckle. Ø22 mm (7/8") button hole.

FS018E-1 For 4 cm (1-1/2") webbing belts

FS019E-1 For 5 cm (2") wide webbing belts

Security Cover



Prevents unsafe opening. This cover's small Ø6 mm (1/4") button hole cannot be operated by a finger, but can be easily opened using a pen tip.

FS018C-1 For 4 cm (1-1/2") webbing belts

FS019C-1 For 5 cm (2") webbing belts

Reduced Access Cover



Requires use of fingertip to open buckle. Ø14 mm (9/16") button hole.

FS018D-1 For 4 cm (1-1/2") webbing belts

FS019D-1 For 5 cm (2") webbing belts

Extra Small Security Cover



Snaps securely onto our Small Push-Button Buckle, limiting access by even the smallest fingers. Open instantly with a pen tip. One size. Ø6 mm (1/4") button hole.

FS029C-1 For 2.5 cm (1") webbing belts

OPTIONAL PULL LOOPS

Can be added to Rehab Latch or DuraLatch buckles for ease of operation.

FS200-10 (10 pack) **FS200-50** (50 pack)





OTHER PELVIC SUPPORT OPTIONS & ACCESSORIES

Leg Harness

A simple solution for users who are at risk for sliding or have spasticity. The padded strap securely holds the leg at the inner thigh without limiting anterior movement or pressing on the bladder. The harness has a unique, user-friendly design and it can be used with or without a pelvic belt. An effective alternative to a groin strap. Sold as a pair.



PART NUMBERS

Select end-fitting and add **-B1** or **-B2** to end of part number before ordering.

(See page 11 for more information.)

- LH600S** **Small**
23 cm (9") x 4 cm (1-1/2")
- LH600M** **Medium**
33 cm (13") x 4.5 cm (1-3/4")
- LH600L** **Large**
38 cm (15") x 5 cm (2")



PART NUMBERS FOR EVOFLEX® AND OTHER PADDED HIP BELTS

To complete the part number for ordering, add the suffix for the selected end-fitting at the end of the part number selected below.

For example: HB205-M46-B1. -B1 or -B2 is the suffix for the end-fittings. See page 38 for all end-fitting options.

TWO-POINT ESSENTIAL BELTS							
Pull Style	Size	Push-Button	Side-Release	Rehab Latch	Swivel Buckle	Small Push-Button	DuraLatch
Center pull	S38		GB215-S38-B5				
	M46		GB215-M46-B5				GB285-M46-B5
	L62		GB215-L62-B5				GB285-L62-B5
TWO-POINT STANDARD PADDED BELTS							
Center-Pull	S32		HB215-S32		HB275-S32	HB235-S32	
	S38		HB215-S38		HB275-S38	HB235-S38	
	M36	HB205-M36	HB215-M36	HB225-M36	HB275-M36		
	M46	HB205-M46	HB215-M46	HB225-M46	HB275-M46		
	L62	HB205-L62	HB215-L62	HB225-L62			
	L82	HB205-L82					
	L92	HB205-L92					
Dual-Pull	S32		HB216-S32				
	S38		HB216-S38				
	M36		HB216-M36				
	M46		HB216-M46				
	L62		HB216-L62				
Rear-Pull	S38		HB219-S38			HB239-S38	
	M40	HB209-M40	HB219-M40	HB229-M40			
	M46	HB209-M46	HB219-M46	HB229-M46			
FOUR-POINT STANDARD PADDED BELTS							
Center-Pull	S32		HB415-S32			HB435-S32	
	S38		HB415-S38		HB475-S38	HB435-S38	
	M36	HB405-M36	HB415-M36	HB425-M36			
	M46	HB405-M46	HB415-M46	HB425-M46	HB475-M46		
	L62	HB405-L62	HB415-L62	HB425-L62			
Dual-Pull	S32		HB416-S32				
	S38		HB416-S38				
	M36		HB416-M36				
	M46		HB416-M46				
	L62		HB416-L62				
Rear-Pull	S38		HB419-S38			HB439-S38	
	M40	HB409-M40	HB419-M40	HB429-M40			
	M46	HB409-M46	HB419-M46	HB429-M46			
TWO-POINT SUB-ASIS-COMPATIBLE BELTS (Sub-ASIS Pads sold separately; see page 7)							
Center-Pull	S38					LB235-S38	
	M46	LB205-M46		LB225-M46			
	L62	LB205-L62		LB225-L62			
Rear-Pull	M46	LB209-M46		LB229-M46			
FOUR-POINT SUB-ASIS-COMPATIBLE BELTS (Sub-ASIS Pads sold separately; see page 7)							
Center-Pull	S38					LB435-S38	
	M46	LB405-M46		LB425-M46			
	L62	LB405-L62		LB425-L62			
Dual-Pull	S38		LB416-S38				
Rear-Pull	M46	LB409-M46		LB429-M46			
EVOFLEX® HIP BELT							
Center-Pull	S38				EB275-S38	EB235-S38	
	M46	EB205-M46		EB225-M46	EB275-M46		
	L62	EB205-L62		EB225-L62			
EVOFLEX® HIP BELT + NEW BELT EXTENDER							
Center-Pull	S38				EB275-S38-EBE	EB235-S38-EBE	
	M46	EB205-M46-EBE		EB225-M46-EBE	EB275-M46-EBE		
	L62	EB205-L62-EBE		EB225-L62-EBE			

UPPER BODY SUPPORT



FOUR-POINT UPPER BODY SUPPORT

MD Series™ Harnesses

Our PivotFit, Stayflex, and Trimline harnesses come with MD (multi-directional) Pull Straps. The versatile MD straps can be set up to work in a front- or rear-pull configuration depending on individual user needs. No need for compromise.



Pivotfit™ Shoulder Harness

The PivotFit harness promotes upright posture through shoulder control for improved breathing, head control, and stability. Sleek look with anatomically-matched design that distributes pressure across a 25% greater surface area than a traditional H-style harness. Body-contouring pads provide optimal support and comfort. Easy-to-adjust sternum strap is placed low to reduce risk of strangulation.

Available in two styles: Standard (non-stretch) and Dynamic (controlled stretch).



STYLE OPTIONS



Standard Style

Non-stretch (fixed) style reduces movement and has an easy-to-clean CORDURA nylon covering. Effective for severe kyphosis, spinal curvature or trunk rotation.



Dynamic Style

Patented, dual-zone elasticity enhances comfort by allowing moderate shoulder movement without reducing support at the chest. Ideal for helping to manage high tone.



STAYFLEX™ CHEST SUPPORT

Provides firm trunk control with more freedom of movement in the shoulders than the PivotFit or Trimline. Patented, dual-stretch-zone construction eliminates upwards shift at the neckline when leaning forward, minimizing strangulation risk. Carefully selected materials optimally balance stretch and resistance, and quick-release Swivel Buckles allow easy removal. Set up any style as a front or rear-pull with our new MD (multi-directional) Pull Straps.

STYLE OPTIONS



Standard Width
Chest support with a controlled amount of stretch.



Narrow Width
Comfortably fits women and users with smaller frames.



Optional Zipper
Optional zipper available on both Standard Width (left) and Narrow Width (right).

Trimline Shoulder Harness

Features two separate, adjustable padded straps for more focused shoulder retraction. Comfortably accommodates asymmetry and keeps the chest clear for maximum freedom of movement.



Essentials H-Style Shoulder Harness

This new, value-engineered design provides strong shoulder positioning for improved head and trunk control. The cleaner appearance and a more ergonomic shape offers greater comfort and performance.



CAUTION

Whenever a chest belt or other anterior trunk support is used, a properly-adjusted pelvic support should also be worn to prevent sliding.

STANDARD END-FITTINGS

Plastic Flat-Mount™ Plastic Cinch-Mount™



MD SERIES HARNESSSES PART NUMBERS

Add end-fitting suffixes **-B5** or **-B6** to the end of the part number.

Size	PivotFit™ Dynamic	Pivotfit™ Standard	Stayflex™ Narrow		Stayflex™ Standard		Trimline	Essentials H-Style
			With Zipper	Without Zipper	With Zipper	Without Zipper		
XXS	SH295XXS	SH290XXS	-	-	-	-	-	-
XS	SH295XS	SH290XS	-	-	-	SH351XS	-	-
S	SH295S	SH290S	-	-	SH350S	SH351S	SH235S	SH224S
M	SH295M	SH290M	SH360M	SH361M	SH350M	SH351M	SH235M	SH224M
L	SH295L	SH290L	SH360L	SH361L	SH350L	SH351L	SH235L	SH224L
XL	SH295XL	SH290XL	SH360XL	SH361XL	SH350XL	SH351XL	-	SH224XL

SHOULDER HARNESS STRAP GUIDES

Improve positioning and comfort of chest and shoulder harnesses, and use harnesses where you couldn't before on low or contoured backs.

Our simple, easy-to-install solution provides maximum adjustability and allows you to optimize fit for each user. The thin design fits into tight spaces, and super strong spring steel absorbs shock, giving users greater comfort.



TWO-POINT UPPER BODY SUPPORT

Monoflex™ Chest Support

For users who need strong but comfortable abdominal or chest support. High-strength elastic padding provides just the right amount of stretch for comfort, while stabilizing even those with strong spastic tone. Double-tapered shape distributes pressure across the midsection while maintaining free arm movement. Improves breath control and speech when used on upper abdomen. Can also be used on legs. Available in one-piece and two-piece styles.

MONOFLEX™ PART NUMBERS

Add end-fitting suffix (-B1, -B2, or -B3) to the end of part number.

Size	One-Piece Underarm Release	Two-Piece Center Release
XS	SH120XS	SH122XS
S	SH120S	SH122S
M	SH120M	SH122M
L	SH120L	SH122L
XL	SH120XL	SH122XL

(See page 31 for more information.)

PRODUCT STYLES



Two-Piece Center Release

Reduces bulk under the arms and fits under lateral supports for added stability. Center Swivel Buckle equalizes pressure.



One-Piece Underarm Release

Single pad for more surface area and stretch, with front-pull adjustment and Swivel Buckle release on sides.



Chest Belt

Features a premium hook-and-loop closure with a stiffened thumb loop for easy adjustment by users with limited hand function. (-B1 or -B2)

One size:

Usable Length: 117 cm (46"); Webbing Width: 5 cm (2")

SH102 Belt only

SH102P Belt with a PD306 slip on pad, shown below.

(See page 38 for more information on end-fittings.)



SH102P - Belt with Slip-On Pad



SH102 - Belt only

LOWER BODY SUPPORT



ANKLE HUGGERS®



THE RIGHT FIT, EVERY TIME

Bodypoint's Ankle Huggers position both ankles and feet for long-term safety.

They allow mobility for a comfortable sitting position in the wheelchair. The ankle is secured while the rest of the foot can move naturally. Load on the joint is reduced and the possibility of a comfortable and durable sitting position with control for the whole body increases.

The Ankle Huggers offer an easy-to-adjust hook-and-loop fastening solution to accommodate different shoes for example, while the ErgoLatch buckle makes it easy to consistently achieve an already set position. The ankle section has padded cushions that follow the shape of the feet and keep the feet centered.

The innovative flex zone for heels and soft wrinkle-free edges in CORDURA textile provide comfort and reduce risks of pressure.



(See page 41 for part numbers and more information)



Padded Aeromesh® Calf Supports

Our Calf Strap and Calf Panel keep feet safely and comfortably on foot plates with relaxed calves. They distribute pressure evenly on the lower extremities and control flex without bruising.

Porous Aeromesh fabric is bonded to a durable but non-creasing stiffener, promoting air flow while maintaining shape.



Calf Strap

- SP102S** Small
- SP102M** Medium
- SP102L** Large

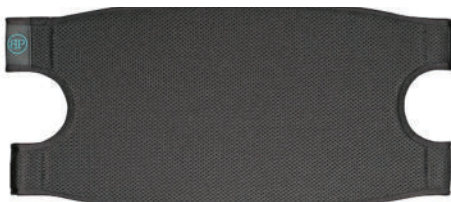

Calf Panel

Distributes pressure across a broader calf region than our regular Calf Strap. Especially helpful for users in tilt or reclined positions.

- SP103S** Small
- SP103M** Medium
- SP103L** Large

CALF PANEL AND CALF STRAP SIZING

Measure the curved distance around the legs from the outside of the wheelchair. Choose a size with enough length for the pad to flex and wrap behind calves.

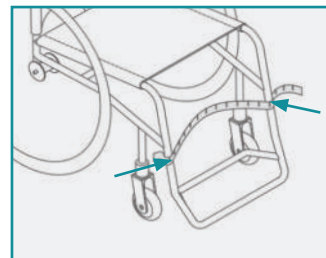

- S** 35-40 cm (14-16")
- M** 40-50 cm (16-20")
- L** 50-61 cm (20-24")

LIFESTYLE OPTIONS





MOBILITY BAG

The Bodypoint Mobility Bag keeps necessities and valuables close at hand, securely and discreetly. Designed in conjunction with wheelchair users, for wheelchair users, it's big enough to hold the day's needs, but still fits snugly out of the way behind the legs or on the side of the chair.

Sturdy construction and handy features like two roomy main compartments, a high-contrast interior, mesh front pockets, a key clip, a hanging hook, and easy-grab pulls make this bag unique.

20cm (8") wide, 19 cm (7.5") tall, 11 cm (4.25") deep



Attach and remove effortlessly from the front or side of the wheelchair using the removable plastic seat clip. Alternately, detach the clip and use the hook-and-loop style tabs to attach to an armrest.



SP001 - Mobility Bag



"I love that it is discreet and fashionable. Nobody even knows it's there."

-Amin Lakhani, Dating Coach on Wheels

Learn more about Amin at
www.bodypoint.com/success-stories.

ELASTIC MOBILITY STRAPS

A versatile band that can be used for support wherever it is needed.

It offers a practical grip with large holes for thumb or fingers for users with limited hand functionality. The material is soft and has a controlled elasticity that gives support and comfort for temporary positioning for work, play, sports, therapy, or fittings. The extra-fine hook-and-loop won't destroy clothes or trap dirt.



Features a convenient thumb loop end for a strong, secure connection.

Elastic Mobility Extension Strap

Optional add-on extension to increase length and versatility. Can also be used alone. All extensions are 72.5 cm (28.5") long.



PRODUCT SIZE



Size	Length	Width	Part Number
Small	148 cm (58")	8 cm (3")	SP110S
Large	148 cm (58")	11 cm (4")	SP110L
X-Large	148 cm (58")	15 cm (6")	SP110XL

BATH & SHOWER POSITIONING



PATENTED AEROMESH® FABRIC

Every shower chair user deserves the soft comfort of Aeromesh. The soft, porous material allows soap, water, dirt, and air to flow through freely while protecting skin and preventing accumulation of bacteria. Combine Aeromesh Bath Belts and Shower Chair Calf Supports for a complete positioning solution.



Aeromesh® Bath Belts

Aeromesh Belts can be worn on the chest or hips to stabilize position while bathing or in the pool. Each length is adjustable, can be machine-washed at temperatures up to 140°F/60°C, and can be machine-dried.



SIZE OPTIONS

A Two-piece pad with grommets

BB101M-1 Medium
10 cm (4") wide
61-94 cm (24-37") long*

BB101L-1 Large
10 cm (4") wide
79-109 cm (31-43") long*

B One-piece pad with grommets

BB111L-1 Large
10 cm (4") wide
73.5-129.5 cm (29-51") long*

BB111XL-1 Extra Large
12.5 cm (5") wide,
81-137 cm (32-54") long*

C One-piece pad, plastic slides

BB112L-1 Large
10 cm (4") wide
68.5-160 cm (27-63") long*

BB112XL-1 Extra Large
12.5 cm (5") wide
76-173 cm (30-68") long*

Measurements represent the usable length of the belt.

SHOWER CHAIR CALF SUPPORT

This clip-on calf support, designed specifically for use while bathing, helps stabilize the legs to reduce risk and increase comfort, especially for tilt shower chair users.

PART NUMBERS & SIZES



Height	Length	Seat Width	Part Number
10 cm (4")	42 cm (17")	40 cm (16")	BB216-22MM
10 cm (4")	47 cm (19")	45 cm (18")	BB218-22MM
10 cm (4")	53 cm (21")	51 cm (20")	BB220-22MM

SIZE AND DIMENSIONS

Measure the seat width

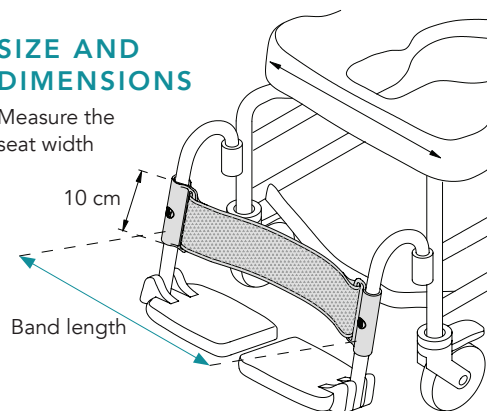

Attaches to frame with sewn-in tubing clips for easy placement and removal. Clips compatible with Ø22 mm and Ø25 mm (1") leg rest tubing and fit most shower chair brands.

MODULAR ARM SUPPORTS





Dynamic Arm Support

The modular solution for elbow, forearm, and hands

Modular and Adjustable Support

The clinically developed Dynamic Arm Support is modular and adjustable, providing an option for intervention and prevention for the upper extremity following injury or neurological events. It provides three points of support at the elbow, forearm, and hand with a focus on preventing contractures, shoulder pain, and shoulder subluxation. The uniquely shaped pads facilitate a functional and neutral position of the forearm and hand.



3 Vital Points of Contact:

1. Elbow Pad
2. Forearm Pad
3. Hand Block

Dynamic Movement:

The pivot mechanism positioned under the elbow pad allows 60° of rotation, stimulating proprioception and increasing strength and range of motion. The position can also be locked in steps of 5° to find the ideal resting position for the user.

PRODUCT SIZE

Step 1: Indicate which arm is impacted: Left or Right

Step 2: Select the size of the hand block: Small or Large

Measure the maximum length of middle finger: Small (8.5cm-10.5cm) or Large (10.5cm-12cm)

Step 3: Choose the type of armrest adapter required: Tubular or Flat

Two sizes of Mounting Clamp to fit Ø19mm, 22mm, and 25mm tubing



POWER WHEELCHAIR CONTROLS





Flex-Shaft Joystick Handles

Bodypoint makes Joystick Handles in a range of shapes, sizes, and materials to address functional needs and personal style.

Flexible shafts reduce risk of damage to electronic joystick controls from involuntary movement, dampen driving vibrations for greater user comfort, and protect fragile components from impact.

Each handle is available in two stem sizes to fit all major power chairs. Install by pressing firmly onto a clean joystick stem.



Grooved Mushroom

The new Grooved Mushroom is the result of years of learning from customers and collaboration with users and clinicians.



"My PT recommended the Bodypoint Joystick Handle... It's supposed to be one of the best. It is better at opening my hand up."

*Wing Woo, Former Sargent
in the King County Sheriff Office*

PRODUCT SIZE

4.8 mm (3/16") stem size:

Fits most Invacare controllers **PC110A**

6.4 mm (1/4") stem size:

Fits Permobil, Pride, Quantum, and Quickie joystick controllers **PC110B**

CONTROL IS RIGHT IN YOUR HANDS



3" Ergonomic U-Shaped

PC101A Fits stem size: Ø4.8 mm (3/16")

PC101B Fits stem size: Ø6.4 mm (1/4")

4" Ergonomic U-Shaped

PC102A Fits stem size: Ø4.8 mm (3/16")

PC102B Fits stem size: Ø6.4 mm (1/4")

Our U-Shaped Joystick Handle is form-fitting and ergonomic due to its curved shape and waterfall edge. This design provides maximum wheelchair driving control while remaining comfortable for users. Available in two widths to accommodate the user's hand size. Sides can be molded to shape in hot water to fit individual needs.



Grooved Mushroom

PC110A Fits stem size: Ø4.8 mm (3/16")

PC110B Fits stem size: Ø6.4 mm (1/4")

The Grooved Mushroom's textured surfaces, hand-filling shape, and adaptable height make it a versatile model that meets the needs of many different users. Can easily be cut to five shorter heights with a utility knife.

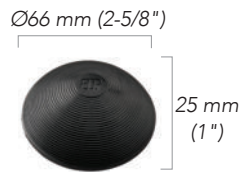
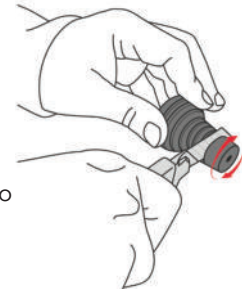

Rubber Dome

PC107A Fits stem size: Ø4.8 mm (3/16")

PC107B Fits stem size: Ø6.4 mm (1/4")

The Rubber Dome Joystick Handle is designed specifically for users with weak hands. Its low, wide form matches the shape of the palm, keeping the wrist neutral and making it easier to control the fingers. Ribbed texture reduces sweat buildup and increases friction to keep hands from slipping off with involuntary movement.

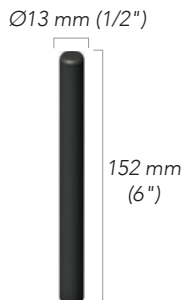

6" Straight

PC104A Fits stem size: Ø4.8 mm (3/16")

PC104B Fits stem size: Ø6.4 mm (1/4")

Our Straight Joystick Handle makes it easy to grasp the joystick using only the last joint of the user's fingers. This design is especially useful for users with very limited hand function. Can also be cut to length for a precise fit.

DRIVING MADE EASIER

Tri-lock™ Midline Mounting System

For many users, driving with the joystick centered in front of the body (at midline) is a more natural and functional position that can lead to improved posture, core strength, and endurance. The Tri-Lock System lets you bring driving controls or communication devices into the optimal position.

Position the arm over lap trays, above or below armrests, or over the shoulder on chin-controlled systems.

Select a Mounting Adapter compatible with the joystick controller, a Mounting Clamp compatible with the chair, and the Midline Arm style that best suits user needs. Components are available separately or as a complete kit.

1. Tri-Lock™ Rotating Shaft

Navigate power chairs with smooth precision, prevent accidental rotation from driving position, and reduce joystick wiggle at the end of the arm with the compact, high-strength Tri-Lock. Rotate smoothly between three positions for driving, transfers, and table use. The unique hidden flip-stops toggle between independent and assisted release.



PC024 Tri-Lock Rotating Shaft

2. Midline Arm style

Now made of satin-finish stainless steel, Bodypoint Midline Arms are corrosion- and scratch-resistant and can be easily cut to a perfect fit using a tube cutter, even while attached to the chair. Each supports up to 13.6 kg (30 lbs) of communication device, phone, tablet, and joystick weight. Choose an L-Shaped Arm for more height and angle options, a Straight Arm for less complex needs, or a J-Shaped Arm to accommodate trays. Lightweight, hollow 12.5 mm (1/2") diameter tubing.



PC031 J-Shaped Arm



PC032 L-Shaped Arm



PC033 Straight Arm

Tri-lock™ Rotating Shaft Positions

Shown with a Straight Midline Arm

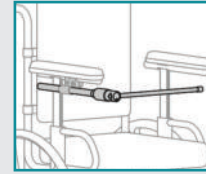

0° Horizontal driving position

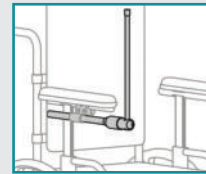

90° For transfers

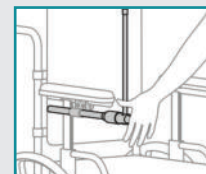

90° Press to disengage

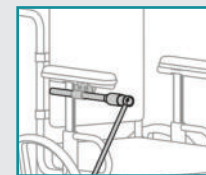

240° For table access

"As a man with C4 quadriplegia, my world is in millimeters. My Bodypoint Midline Joystick gives me independence allowing me to drive with my chin-this is critical to my success! I've had the Midline now for more than a decade and it has not failed. Period."

Todd Stabelfeldt, Information Technology Entrepreneur

Read more about Todd Stabelfeldt's story at

www.bodypoint.com/success-stories



3. Joystick Mounting Adapter

Use to attach almost any joystick controller to a Bodypoint Midline Arm. Our adapters are strong, easy to install, and fit a wide range of controller models.

For more controller compatibility information, please visit www.bodypoint.com/midline.



PC042
For MK6i, MPJ+



PC045
For PGDT Pilot+



PC046
For MK5, MPJ,
Q-Logic



PC047
For Permobil
Compact Joysticks

4. Armrest Mounting Clamp

The Tri-Lock Modular Mounting Clamp is an essential component for mounting the Tri-Lock Rotating Shaft to the power chair. Both styles are height adjustable and can be installed on either the left or right armrest.

The optional Quick-Release Lever attaches to the clamp to allow easy adjustment and removal of the Tri-Lock Rotating Shaft.



PC010
Rail Mount
Fits Permobil
Unitrack and Pride
T-slotted armrests



PC011
Tube Mount
Fits Invacare Ø22
mm, 7/8" round-
tube armrests



FA171
Quick-Release Lever
For easy adjustment
and removal of the Tri-
Lock Rotating Shaft

MIDLINE JOYSTICK MOUNTING KITS

Midline Arm Style	Armrest Mounting Clamp	Joystick Mounting Adapter			
		PC042	PC045	PC046	PC047
J-Shaped	Rail Mount	PC202-10J	PC205-10J	PC206-10J	PC207-10J
	Tube Mount	PC202-11J	PC205-11J	PC206-11J	PC207-11J
L-Shaped	Rail Mount	PC202-10L	PC205-10L	PC206-10L	PC207-10L
	Tube Mount	PC202-11L	PC205-11L	PC206-11L	PC207-11L
Straight	Rail Mount	PC202-10S	PC205-10S	PC206-10S	PC207-10S
	Tube Mount	PC202-11S	PC205-11S	PC206-11S	PC207-11S

Kits contain: 1 Tri-Lock Rotating Shaft, plus choice of Midline Arm, Mounting Clamp, and Mounting Adapter.

TECHNICAL



HOW TO MEASURE FOR A PADDED HIP BELT

To ensure proper fit and best performance, always select the padded belt size that best fits the user. When working with the Evoflex, consider adding Belt Extenders if longer straps are needed to reach the desired mounting point.

Determine the correct belt size for the user:

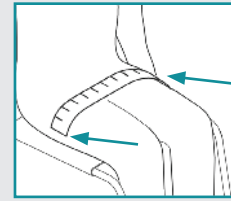
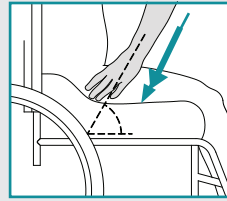

1. Based on clinical goals, use arms to place user in desired position and determine the most effective position and angle for the belt.
2. At the selected belt angle, measure the distance over the body with a flexible tape to find the optimal length for the belt's padded section.
3. In the sizing table for your belt style, refer to Column B to find the appropriate belt size based on padded length. If user is between sizes, consider factors such as growth, weight variations and clothing changes. For proper fit and function, pads should not extend past the user's body.

Two-Point and Four-Point Padded Hip Belts

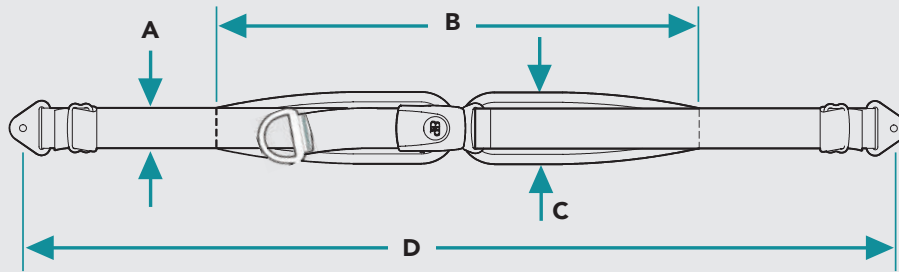

Size	A	B	C	D
S32	2.5 cm (1")	32 cm (12-1/2")	4.5 cm (1-3/4")	117 cm (46")
S38	2.5 cm (1")	38 cm (15")	5 cm (2")	117 cm (46")
M36	4 cm (1-1/2")	36 cm (14")	5.5 cm (2-1/4")	130 cm (51")
M40	4 cm (1-1/2")	40 cm (15-3/4")	5.5 cm (2-1/4")	142 cm (56")
M46	4 cm (1-1/2")	46 cm (18")	5.5 cm (2-1/4")	142 cm (56")
L62	5 cm (2")	62 cm (24-1/2")	7 cm (2-3/4")	155 cm (61")
L82	5 cm (2")	82 cm (32")	9 cm (3-1/2")	206 cm (81")
L92	5 cm (2")	92 cm (36")	10 cm (4")	206 cm (81")

Leg Harnesses

Measure from the anterior superior iliac spine (ASIS) to the point where the inner thigh touches the seat.

Size	Fit Range
S	20-28 cm (8-11")
M	28-36 cm (11-14")
L	36-41 cm (14-16")

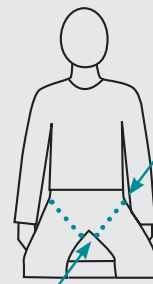

ADDITIONAL INSTRUCTIONS FOR THE EVOFLEX®

Determine total length needed for mounting:

1. At the selected belt angle, measure from the mounting point on one side across the user's body to the mounting point on the other side.
2. In the Evoflex sizing table, refer to Column D to find the maximum mounting length for the selected size belt.
3. If belt will not be long enough to reach the mounting points, Evoflex Belt Extenders can be used to add up to 12.5 cm (5") per side. See the Evoflex + Belt Extender table below for maximum combined length. Both the Evoflex Belt and Belt Extender can be cut to length if needed. See page 9 for Belt Extender details.

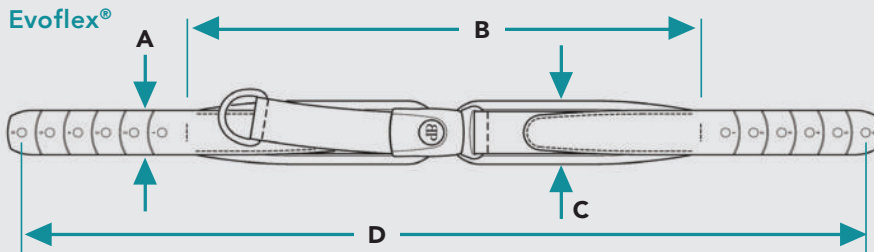
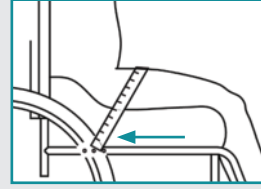

Size	A	B	C	D
S38	2.5 cm (1")	38 cm (15")	5 cm (2")	63 cm (24-3/4")
M46	4 cm (1-1/2")	46 cm (18")	5.5 cm (2-1/4")	76 cm (29-3/4")
L62	5 cm (2")	62 cm (24-1/2")	7 cm (2-3/4")	96 cm (37-3/4")

Evoflex® + Belt Extender

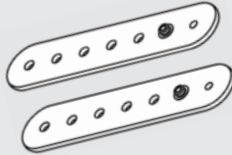

Belt Size	Max mounting length With Belt Extender
S38	88 cm (34-3/4")
M46	101 cm (39-3/4")
L62	121 cm (47-3/4")

See page 40 for more information on Evoflex Belt Extender.

Non-Padded Hip Belts

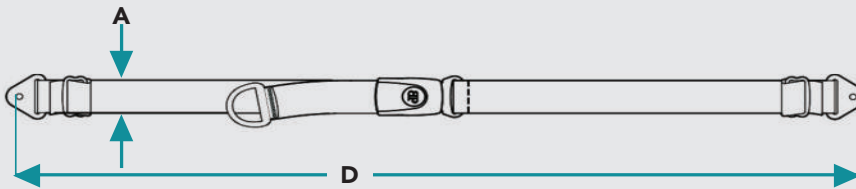

Part Numbers by Buckle Style

Size	Push-Button	Side-Release	Rehab Latch™
S		NB215S	
M	NB205M	NB215M	NB225M
L	NB205L	NB215L	NB225L
L-EXT	NB205L-EXT		

Size	A	D
S	2.5 cm (1")	117 cm (46")
M	4 cm (1-1/2")	142 cm (56")
L	5 cm (2")	155 cm (61")
L-EXT	5 cm (2")	206 cm (81")

Select end-fitting and add **-B1** or **-B2** to end of part number.

END-FITTINGS FOR HIP BELTS & HARNESSSES

METAL END-FITTINGS FOR HIP BELTS & MONOFLEX™

 -B1	 -B2	 -B3	 -B5
Flat-Mount™ Versatile, lowest profile	Cinch-Mount™ Allows quick, easy, and precise adjustments to strap length for changes in weight and clothing	Grommet Strap One-piece Monoflex only	Plastic Flat-Mount™ Metal reinforced plastic end-fittings for Essentials hip belts

PLASTIC END-FITTINGS FOR HARNESSSES

Cam Buckles

Convenient end-fitting option for evaluation setting or whenever temporary fittings are needed. Also suitable for long-term use with chest or shoulder harnesses on users up to 75 kg (165 lb). Mount to solid backrest or Strap Guides. Ø6 mm (1/4") hole. Sold in pairs.



FS032-2 Fits 2.5 cm (1") wide webbing

FS033-2 Fits 4 cm (1-1/2") wide webbing

FS034-2 Fits 5 cm (2") wide webbing belts

Standard End-Fittings

Plastic Flat-Mount

Plastic Cinch-Mount



ADDITIONAL MOUNTING OPTIONS

These optional harness attachment methods are especially useful for installation challenges such as contoured backs and tight spaces.

Grommet Straps

Clip to the end of MD Pull Straps for more compact front-pull installations. Sold in pairs.

SH025-2



1" Cam Buckle

Use with D-ring section of MD Pull Straps for rear-pull function with compact installation and easy adjustment. Best for temporary use or pediatrics. Long-term use on users up to 75kg (165 lb) only. Sold in pairs.

FS032-2



HARDWARE TO ATTACH TO THE WHEELCHAIR



FrameSaver™ Clamp & Shim

Frame types: A, D

Strong, durable nylon clamps snap onto tubing and won't scratch surface. Our most affordable clamp, the FrameSaver is perfect when clearance is not an issue. Sold in pairs.

HW303-B-2 25 mm clamp + 22 mm shim

HW303-19SHIM-2 19 mm shim



Band Clamp

Frame types: A, B, C, D

Flexible stainless spring steel fits into tight gaps under seats on a wide variety of frames. Useful for mounting where there are no pre-existing holes.

HW320-22-2 Ø22 mm (7/8")

HW320-25-2 Ø25 mm (1")

HW320-27X33-2 27 x 33 mm (1-1/16" x 1-5/16"), oval

HW320-29-2 Ø29 mm (1-1/8")

HW320-30-2 Ø30 mm (1-3/16")

HW320-32-2 Ø32 mm (1-1/4")



Frame Clamp

Frame types: A, C

Open-jaw design fits underneath seat upholstery and armrest pads. Made with sturdy, two-piece aluminum construction. Sold in pairs.

HW310-22-A-2 Ø22 mm (7/8")

HW310-25-A-2 Ø25 mm (1")

Directly mount belts or harnesses to power wheelchair slotted rails.



6 mm T-Slot Fastener Kit

Frame type: E

Metal end fittings:
HKA6-12MM

Plastic end fittings:
HKA6-14MM



10 mm T-Slot Fastener Kit

Frame type: F

Metal end fittings:
HKA10-14MM

Plastic end fittings:
HKA10-19MM



90° Seat Mounting Bracket

Frame type: C

HW200-90-2



20° Seat Mounting Bracket

Frame type: D

HW200-20-2



Mounting solution for chairs with sling seat upholstery or a solid seat base. 90° bend for top mounting on seat tubes or a 20° bend for side mounting. Sold in pairs.

FRAME TYPE

Identify chair's frame type and then select compatible mounting hardware for belts and harnesses.

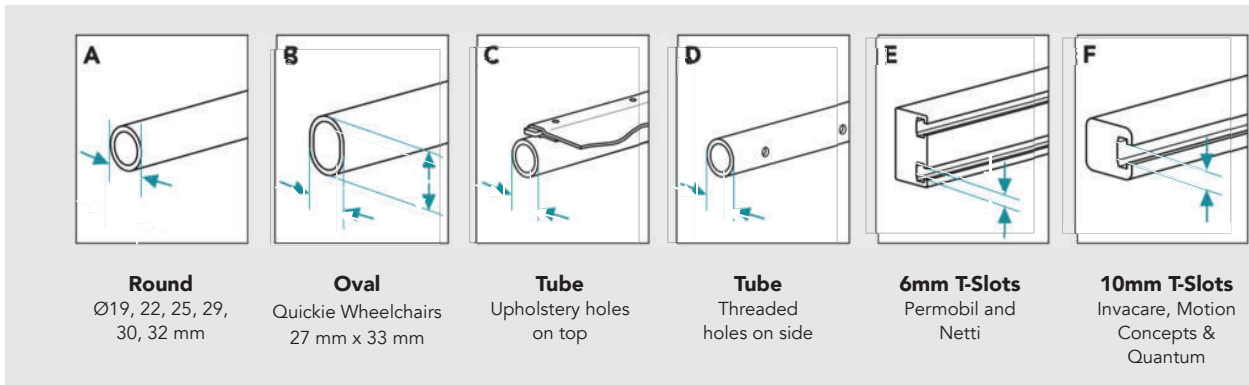

OTHER HARDWARE

Evoflex® Belt Extender

Made of high-impact plastic, the Evoflex Belt Extender maintains the stiffness of the Evoflex while lengthening the belt up to 12.5 cm (5") on both side. Perfect for mounting to wheelchairs with thicker cushions, deeply contoured seating, or distant mounting points. Available separately or bundled with the Evoflex belt.

EBE100



Strap Guide Part Numbers

Sold in pairs with complete M6 fastener kit and spacers.

HW100-200-2 Long 200 mm (8")

HW100-150-2 Short 150 mm (6")



Permobil Corpus Fastener Kit

Fastener kit for attaching Strap Guides to T-slots on Permobil Corpus chairs. Sold as a kit.

HW101P-1



This indispensable tool for measuring tubing diameter helps you choose the correct mounting hardware. It's also an easy way to select correctly-sized screws and nuts for a particular wheelchair.

BMR-42



SHOULDER HARNESS STRAP GUIDES

Stayflex™, Pivotfit™ and Trimline

Measure the maximum width across the shoulders, at the deltoid muscles.

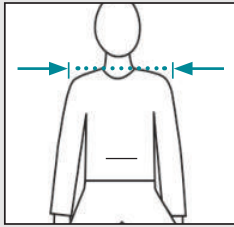

Size	Shoulder Width
XXS*	21-24 cm (8-1/4 - 9-1/2")
XS	24-28 cm (9-1/2 - 11")
S	28-33 cm (11-13")
M	33-41 cm (13-16")
L	41-48 cm (16-19")
XL	48-56 cm (19-22")

Monoflex™ Chest Supports

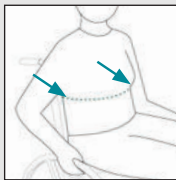

Measure the trunk around the front and sides at the height at which the Monoflex will be worn.

Size	Pad Length	Pad Width	
		Underarm Release (1-piece)	Center Release (2-piece)
XS	31 cm (12-1/4")	7 cm (2-3/4")	5.5 cm (2-1/4")
S	39.5 cm (15-1/2")	7.5 cm (3")	6.5 cm (2-1/2")
M	46.5 cm (18-1/4")	10 cm (4")	8 cm (3-1/4")
L	54.5 cm (21-1/2")	11.5 cm (4-1/2")	9 cm (3-1/2")
XL	62 cm (24-1/2")	12.5 cm (5")	9.5 cm (3-3/4")

CALF SUPPORTS & ANKLE HUGGERS

Calf Supports (Calf Strap and Calf Panel)

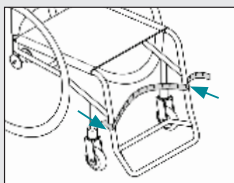

Measure the curved distance around the legs from the outside of the wheelchair. Choose a size with enough length for the pad to flex and wrap behind calves.

S	35-40 cm (14-16")
M	40-50 cm (16-20")
L	50-61 cm (20-24")

Ankle Huggers®

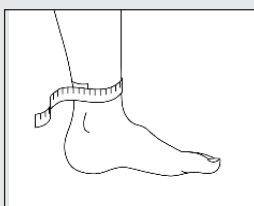

Measure circumference above ankle.

Size	Part Number	Fits Ankle Circumference
XS	FT240XS	14-17 cm (5-1/2-6-3/4")
S	FT240S	16.5-20 cm (6-1/2-8")
M	FT240M	19-25.5 cm (7-1/2-9-1/4")
L	FT240L	23-28 cm (9-11")
XL	FT240XL	26.5-33 cm (10-1/2-13")

Additional sizing information can be found in the product listings throughout this Product Guide and online at www.bodypoint.com.

TECHNICAL SECTION: HARNESSES SPECIAL HARDWARE

Strap Guide Mounting Adapters

Optional Mounting Adapters allow you to utilize existing headrest holes, minimizing the need for drilling without limiting options for strap guide position. Sold separately with M6 fasteners and nut plates.



HW105L-1

Large 270 mm x 75 mm (10-5/8" x 3")

HW105S-1

Small 185 mm x 75 mm (7-1/4" x 3")

*Small Mounting Adapter
used to mount Short Strap Guides.
Headrest hardware not included.*

BEST PRACTICES FOR HARNESSES MOUNTING

TOP STRAP (LATERAL PLACEMENT)

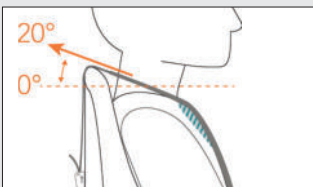
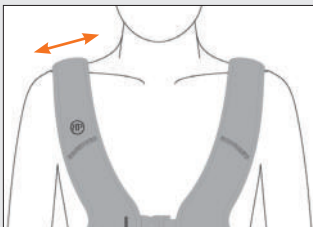

When the top straps are pulled at an upward angle, above shoulder level, shoulder envelopment is reduced.

TOP STRAP (MOUNTING ANGLE)

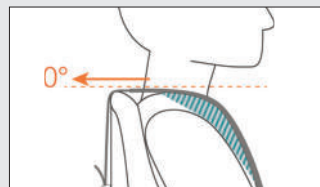
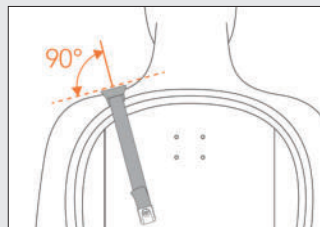

When the straps are pulled straight back, at shoulder level, shoulder envelopment is increased. The distance to the contact point on the chair is also a little shorter, which may reduce lateral shifting of the top straps.

STRAP GUIDES

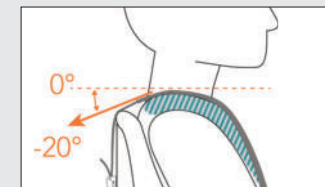
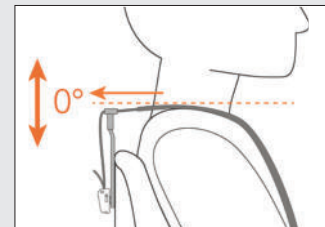

When the straps are pulled at a slightly downward angle, up to 20° below shoulder level, shoulder envelopment is maximized. Mounting lower than 20° below the shoulder is not recommended because of the potential increase in downward force.

TERMS AND CONDITIONS

LIMITED LIFETIME WARRANTY

Most products manufactured by Bodypoint carry a limited lifetime warranty against defects in workmanship and materials arising under normal use by the original consumer. Product specifications are subject to change. For current specifications and warranty details, contact your local Independent Distributor or contact Customer Service at sales@bodypoint.com or 1-800-547-5716.

LIMITATIONS ON WARRANTIES

The warranties described herein do not extend to normal wear and tear; to products that have been subject to misuse, accident or tampering; nor to products that have been modified in any way other than that specifically described in the product instructions. Normal wear and tear is damage that naturally and inevitably occurs as a result of typical use. Purchaser's sole remedy for defective products shall be repair, replacement or account adjustment at the discretion of Bodypoint. In all circumstances Bodypoint reserves the right to substitute an equivalent product or refund the purchase price of the original product.

The Foregoing Warranties Are In Lieu Of All Other Warranties Expressed Or Implied, Including Without Limitation, Implied Warranties Of Merchantability And Fitness For A Particular Purpose. In No Event Shall Bodypoint Be Liable For Any Special, Indirect, Incidental Or Consequential Losses Or Damages Resulting From The Use Of The Product, Including Without Limitation, Loss Of Anticipated Profits, Even If Bodypoint Shall Have Been Advised Of The Possibility Of Such Potential Loss Or Damage. Bodypoint Shall Not Be Liable For Any Loss Or Damage Caused By Delay In Furnishing Product.

Bodypoint does not authorize any distributor, dealer, agent, sales person or any third party to change the terms or coverage of this warranty, and any such change shall be null and void. This warranty is non-transferable. This warranty will be governed in accordance with the laws of the State of Washington. The customer consents that jurisdiction under Venue for any action shall be in King County Washington. This warranty information is reprinted here for information purposes only and is subject to change without notice.

TERMS

Standard terms are net 30 days on accounts approved for credit. Any returned check will incur a \$50 service charge. We also accept Visa, MasterCard, or American Express. All shipments are FOB Seattle, Washington.

Product specifications, prices, terms and conditions are subject to change without notice. Contact Customer Service at sales@bodypoint.com or 1-800-547-5716 for further details.

PAST DUE ACCOUNTS

Past due invoices will incur finance charges at the rate of 1.5% per month. Bodypoint reserves the right to hold shipments or require prepayment for any delinquent account.

RETURNS

All returns must be pre-authorized by Bodypoint. Customer must contact Bodypoint within 30 days of the purchase date for a return authorization. All returns are subject to a 15% restocking fee, plus applicable freight charges.

TRADEMARK INFORMATION

- Bodypoint and the Bodypoint Logo are registered trademarks of Bodypoint, Inc. in Canada, China, the EU, India and the USA.
- Strengthen Your Position is a registered trademark of Bodypoint, Inc. in the EU and USA.
- Ankle Huggers is a registered trademark of Bodypoint, Inc. in Canada, the EU and the USA.
- Aeromesh is a registered trademark of Bodypoint, Inc. in the EU and the USA.
- Evoflex is a registered trademark of Bodypoint, Inc. in the USA.
- Cinch-Mount, Flat-Mount, FrameSaver, Stayflex, Laminar Pad, Monoflex, Rehab Latch, DuraLatch, PivotFit, MD Series, and MD Pull Straps are all trademarks of Bodypoint, Inc.



TRANSCENDENCE

"Right away when I first started chatting with Bodypoint, I could tell that everybody here really cares about what they do.

You know, this is a really tight knit community of people who know that the work that they do contributes to making a better society and a better life for a lot of people who have mobility limitations.

Bodypoint helps to create a connection between the person and the equipment, and if you have that intimate connection, then you can do anything. You can transcend the disability."

- Josh Dueck, Professional Skier, Paralympian, & Bodypoint User

CONTACT US

www.bodypoint.com

Phone: 206.405.4555 or toll-free 800.547.5716

Fax: 206.405.4556 or toll-free 800.767.3828

sales@bodypoint.com

Customer Service Hours: Monday-Friday, 7am-4:30pm (PST/PDT)



STRENGTHEN
YOUR
POSITION

